

Flush-mounted pressure and filling level transmitter - KERAMESS KS 050D - series

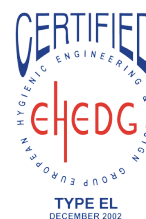
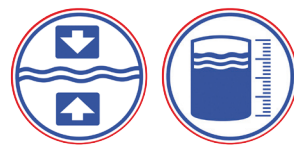

FEATURES

- MECHANICALLY ROBUST, DRY CERAMIC MEASURING CELL, SUITABLE FOR VISCOUS AND ABRASIVE MEDIA
- OUTPUT SIGNAL 4...20mA, TURNDOWN 4
- ACCURACY $\leq \pm 0.2\%$ FS
- SIMPLE CALIBRATION, EVEN WITHOUT DISCONNECTION OF THE TRANSMITTER, THROUGH SWITCHABLE POWER SUPPLY PLANT/ CALIBRATOR SUPPLY
- SIMPLE PARAMETERING VIA 2-KEY CONCEPT AND MULTIPLE-COLOUR STATUS LED
- WITH HYGIENIC AND STANDARD PROCESS CONNECTIONS AS A FIXED CONNECTION
- FOR MEASUREMENT OF THE PRESSURE AND FILLING LEVEL IN TANKS AND PIPES WITH BASIC REQUIREMENTS

DESCRIPTION

The KS050D pressure transmitter is suitable for measuring the pressure and filling level in tanks and pipes. Its capacitive measurement cell and ceramic membrane makes the KS050D the ideal candidate for use in applications with abrasive media. KERAMESS pressure transmitters are designed for a measuring range of $-1/0 \dots 1$ bar to $-1/0 \dots 70$ bar. Special measuring ranges are also available.

The 050D series pressure transmitters are equipped with a micro-processor controlled electronics system and an accuracy of $\leq \pm 0.2\%$ FS. They are parametrised with a simple and user-friendly operating concept via 2 keys and a multi-colour status LED. A TurnDown of up to 4 can be set using the full and empty adjustment.

The large range of hygienic process connections such as e.g. the VARIVENT®, clamp DIN 32676, conical coupling with DIN 11851 groove union nut etc. guarantee the KS050D a variety of applications in the food industry and all other hygienic applications. A wide variety of process connections are also available for non-hygiene applications. Their use in hygienic applications are assisted by the robust stainless steel field housing in the IP 67 and IP 69K, which withstands extremely aggressive cleaning techniques. The KS050D pressure transmitters are highly-suited to use in applications which strict hygiene standards and basic requirements of functionality and accuracy.

Flush-mounted pressure and filling level transmitter - KERAMESS KS 050D - series



TECHNICAL DATA

General details						
Device type/measuring principle	KS050D: capacitive					
Input						
Measuring ranges	KS050D					
Standard nominal measuring range [bar]	Relative	OP	Relative	OP	Absolute	OP
OP = overload protection [bar] Special measuring ranges are available on request. All measurement cells are vacuum safe	0.05	4	40	60	0.1	4
	0.1	4	70	105	0.2	6
	±0.1	4	-1 to 1	10	0.4	6
	0.2	6	-1 to 2	18	1	10
	0.4	6	-1 to 4	25	2	18
	1	10	-1 to 10	40	4	25
	2	18	-1 to 20	40	10	40
	4	25	-1 to 40	60	20	40
	10	40	-1 to 70	105	40	60
	20	40			70	105
Setting the measuring ranges	via the 2 keys within the transmitter					
Setting ranges	Measuring range begin zero: 0 to 75% of the sensor's nominal measuring span Measuring span span: 25 to 100% of the sensor's nominal measuring span TD=4					
Burst pressure DIN16086	≥ 4-fold nominal measuring range					
Output						
Output signal	2-wire: 4 to 20mA with a test circuit connection in the device					
Fault signal	22mA					
Current limitation	3.8mA and 21mA (normal operation, cannot be set)					
Measuring accuracy						
Reference conditions	acc. to DIN IEC 770					
Linearity, hysteresis and repeatability acc. to the limit point method DIN IEC 770	≤ ± 0.2% of the sensor nominal measuring range					
Activation time	< 2 s (The device will perform a self-test.)					
Setting time	< 1 s					
Long-time drift	≤ 0.2% of the span per year					
Thermal hysteresis	≤ 0.2% of the sensor's nominal measuring range / 10K (-20 to +80°C) from 4 bar ≤ 0.3% of the sensor's nominal measuring range / 10K (-20 to +80°C) up to 0.6 bar					
Conditions of use						
Installation position / calibration position	Any position / standing vertically					
Medium temperature	-40 °C to +125 °C (140 °C for max. an hour)					
Ambient storage temperature	-40...+85°C (below -20 °C danger of cable breakage)					
Protection class acc. to EN60529	IP 67 and IP 69K					
Electromagnetic compatibility	acc.to EN 61326-1					
Construction						
Electrical connection	- Standard: M16x1.5 cable screw connection, nickel-plated brass (stainless steel available on request) - Optional: M12x1 round plug-in connector, nickel-plated brass (stainless steel available on request) - Optional: angle plug acc. to EN 175301-803 - Optional: reference cable					
Process connection	- All standard flush-mounted process connections and those commonly used by the manufacturer					
Construction						
Materials	- Field housing / lid: CrNiSt 1.4301 (304) - Electronics cast: Silgel - Housing seal: FPM (Viton®) - Pressure compensation element: Polyamide - Process connection / connection adapter: CrNiSt 1.4404 (304) - Process membrane: Al ₂ O ₃ (99%) - Reference cable, 5-wire with reference tube: PUR (recommended: 80 m maximum)					
Display and operation						
Display	Multiple-colour status LED					
Operation	2-key concept					
Auxiliary energy resources						
Power supply / burden	12...30V DC, max. burden: (V _{supply} - 12V) / 22mA					

Flush-mounted pressure and filling level transmitter - KERAMESS KS 050D - series

Accessories 050D

Certificates	Calibration certificate Declaration of conformity Material certificate acc. to EN 10204 EHEDG certificate
--------------	--

DIMENSIONAL DRAWINGS (dimensions in mm)

KERAMESS 050D ... _K(M)

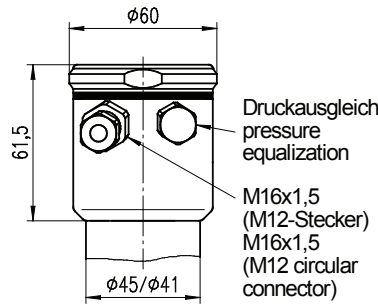

Prozessanschlüsse (weitere Ausführungen auf Anfrage)
process-connections (other constructions on request)

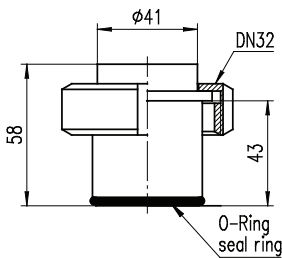

aseptischer Anschluss (N3)
aseptical process-connection (N3)

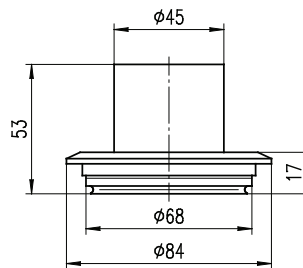

VARIVENT-Flansch Ø68 (V8)
VARIVENT-flange Ø68 (V8)

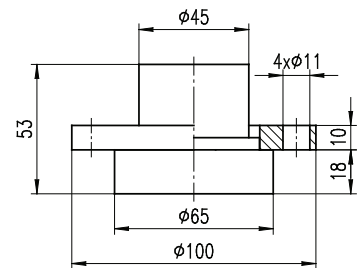

DRD-Flansch Ø65 (D6)
DRD-flange Ø65 (D6)

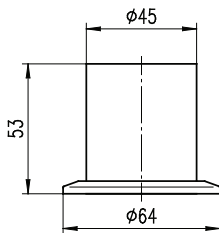

Clamp DIN 32676 - DN50 (C5)

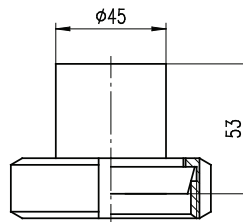

Kegelstutzen DIN 11851
conical nozzle DIN 11851
DN40 (M4), DN50 (M5)

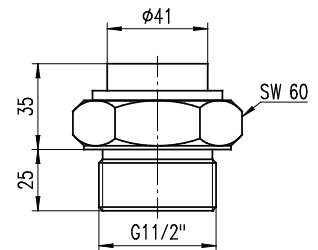

Einschraubgewinde DIN ISO 228
G1 1/2B (G5)
external thread DIN ISO 228
G1 1/2B (G5)

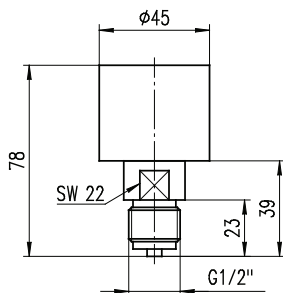

Einschraubgewinde EN 837
G1/2B (G2)
external thread EN 837
G1/2B (G2)

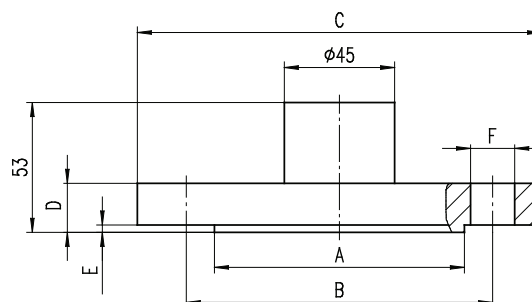

Flansch EN 1092-1
flange EN 1092-1
DN50 (F5), DN80 (F6)

	DN50	DN80
A	Ø102	Ø138
B	Ø125	Ø160
C	Ø165	Ø200
D	20	24
E	3	3,5
F	4xØ18	8xØ18

Flush-mounted pressure and filling level transmitter - KERAMESS KS 050D - series



ORDER INFORMATION for KERAMESS KS

Process connection

C5	Clamp acc. to DIN32676 DN50/PN16, flush-mounted
D6	DRD flange d = 65mm
F5	Flange acc. to EN 1092-1 (DIN2527 D) DN50 / PN10-40, flush-mounted
F6	Flange acc. to EN 1092-1 (DIN2527 D) DN80 / PN10-40, flush-mounted
G2	Screw-in thread G $\frac{1}{2}$ " , acc. to EN837, sensor inside (pressure gauge connection)
G5	Screw-in thread G1 $\frac{1}{2}$ " , acc. to ISO228, flush-mounted
M4	Conical coupling with groove union nut acc. to DIN 11851, DN40 / PN40 , flush-mounted
M5	Conical coupling with groove union nut acc. to DIN 11851, DN50 / PN25 , flush-mounted
N3	Aseptic process connection with a groove union nut
V8	VARIVENT® flange d=68 / PN16, for DN 40-125 pipe, flush-mounted
S9	Alternative process connection available on request

Sensor measuring range / pressure type

A	0.05bar max. overload 4bar
B	0.1bar max. overload 4bar
T	0.2bar max. overload 6bar
D	0.4bar max. overload 6bar
E	1bar max. overload 10bar
F	2bar max. overload 18bar
H	4bar max. overload 25bar
K	10bar max. overload 40bar
L	20bar max. overload 40bar
N	40bar max. overload 60bar
P	70bar max. overload 105bar

R Relative pressure, overpressure (0...xxxbar)

N Relative pressure, overpressure (0...xxxbar)

A Absolute pressure

Electrical connection

K	M16x1.5 cable screw connection
M	M12x1 round plug-in connector
R05	Reference cable 5m, permanently connected
R10	Reference cable 10m, permanently connected
R15	Reference cable 15m, permanently connected
R20	Reference cable 20m, permanently connected
R25	Reference cable 25m, permanently connected
RXX	Reference cable, length over 25m, please specify in plain text (max. 80m)

Measurement cell seal

2	EPDM (FDA conform)
3	FKM (O-Ring)
4	FKM (FDA conform)
5	FFKM (O-Ring)

KS050D

--	--	--	--	--	--	--	--	--	--

Nominal measurement area if it deviates from the sensor measurement area

Please observe the permissible nominal pressure of the process connection selected.
 All specifications and certifications specified are only guaranteed when Hengesbach original components are used.
 Our devices are subject to constant development; subject to technical modification.