

Solenoid valves VUVG/valve terminals VTUG

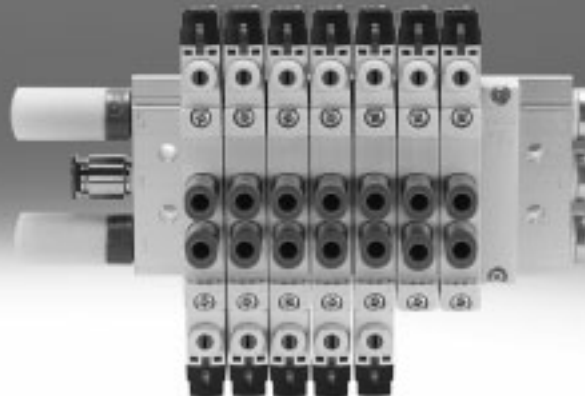

Festo core product range
Covers 80% of your automation tasks

Worldwide:
Superb:
Easy:

Always in stock
Festo quality at an attractive price
Reduces procurement and storing complexity

★ Ready for dispatch from the Festo factory in 24 hours
Held in stock in 13 service centres worldwide
More than 2200 products

★ Ready for dispatch in 5 days maximum from stock
Assembled for you in 4 service centres worldwide
Up to 6×10^{12} variants per product series

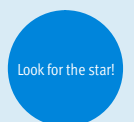



New

VUVG-LK, VUVG-BK

Solenoid valves VUVG

Key features

FESTO

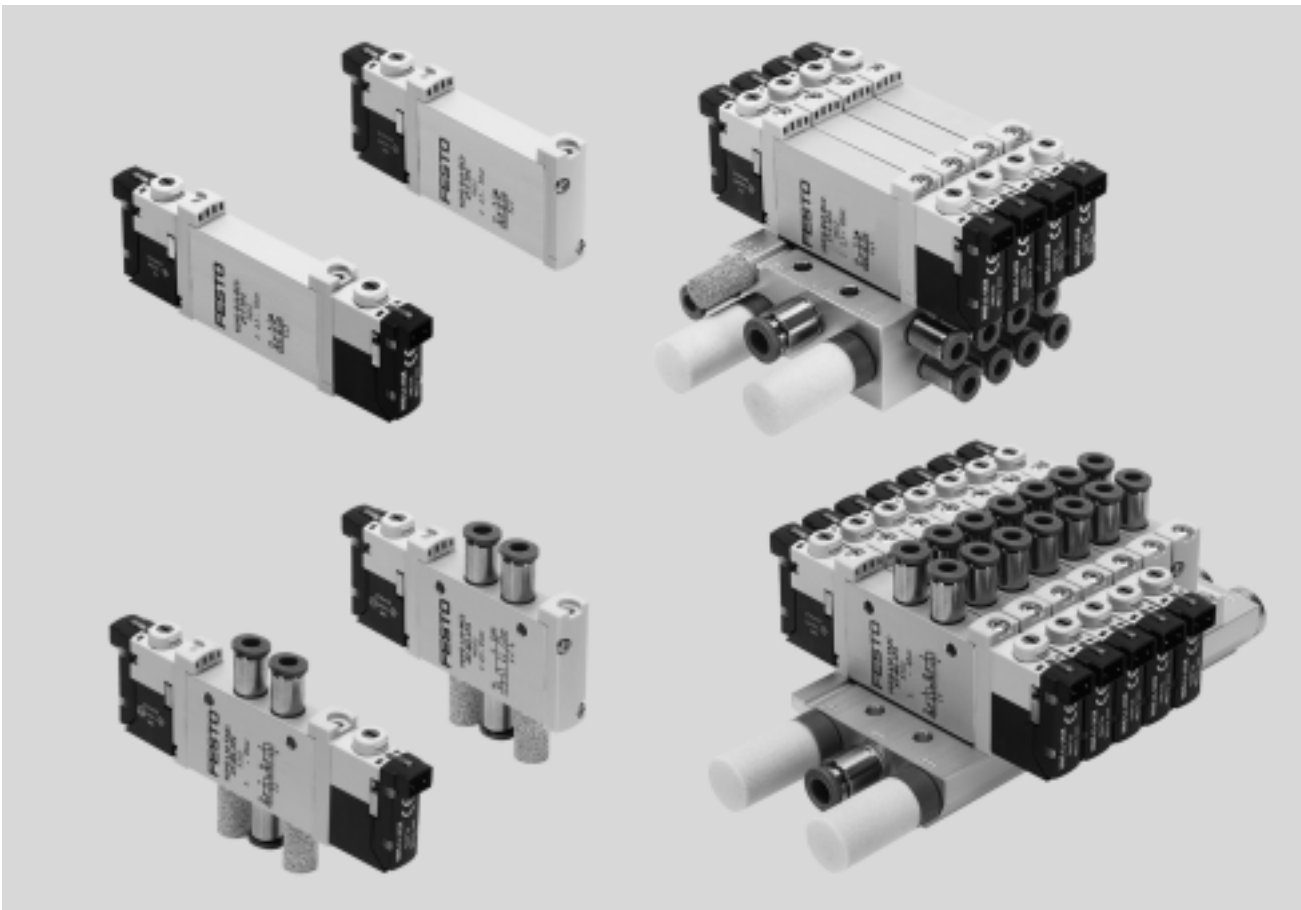

Innovative

- Can be set to internal or external pilot air supply for manifolds with sub-base valves
- Connection technology easy to change via the electrical connection box
- Maximum pressure 10 bar
- Design principle:
 - Piston spool with sealing ring (VUVG-LK, VUVG-BK)
 - Piston spool with sealing cartridge (VUVG-L, VUVG-B)

Versatile

- Wide range of valve functions
- Choice of quick push-in connectors
- In-line valves
- Semi in-line valves for manifold assembly
- M5 and M7 in-line valves can be combined on one manifold rail
- Valve manifold with pressure zones
- IP40, IP65

Reliable

- Sturdy and durable metal components
 - Valves
 - Manifold rails
- Fast troubleshooting thanks to 360° LED display
- Convenient servicing thanks to valves that can be replaced quickly and easily
- Choice of manual override: non-detenting, covered, non-detenting/detenting or detenting (without accessories)

Easy to install

- Secure mounting on wall or H-rail
- Easy mounting, captive screws and seal
- Connection technology easy to change via the electrical connection box
- Inscription label holder for labelling the valves

Valve terminal configurator

A valve terminal configurator is available to help you select a suitable valve terminal VTUG. This makes it much easier to order the right product. Valve terminals VTUG are ordered via an ident. code.

All valve terminals are supplied fully assembled and individually tested. This reduces assembly and installation time to a minimum.

Ordering system for valve terminal VTUG

➔ Internet: vtug

Download CAD data ➔ www.festo.com

Solenoid valves VUVG

Key features – Pneumatics

Individual valves and valve manifolds

In-line valves as individual valve

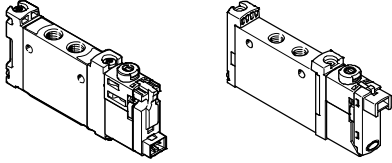

In-line valve VUVG-LK/VUVG-L

In-line valves are designed to be used without pneumatic linking. All pneumatic connections are on the valve and can be equipped with fittings/tubing. The electrical connection is provided by different electrical connection boxes.

If a special seal set is used, in-line valves VUVG can also be mounted on a manifold rail (pneumatic linking) as semi in-line valves.

Semi in-line valves for manifold assembly

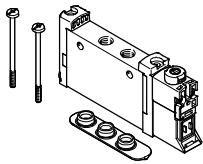

Semi in-line valve VUVG-S

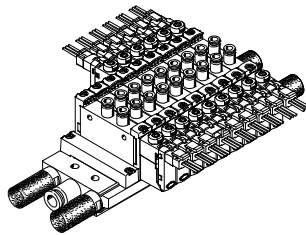

Valve manifold VTUG comprised of semi in-line valves VUVG-S

In the case of semi in-line valves, the supply ports (1, 3 and 5) are connected to the valve via pneumatic linking (e.g. sub-base).

The working ports (2, 4) are on the valve. The electrical connection is provided by different electrical connection boxes.

Sub-base valves for manifold assembly

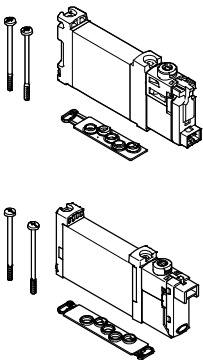

Sub-base valve VUVG-BK/VUVG-B

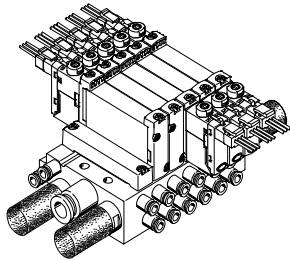

Valve manifold VTUG comprised of VUVG-BK/VUVG-B sub-base valves

In the case of sub-base valves, the supply ports (1, 3 and 5) and the working ports (2, 4) are connected to the valve via the pneumatic linking (e.g. sub-base).

The electrical connection is provided by different electrical connection boxes.

New
VUVG-LK, VUVG-BK

Solenoid valves VUVG

Key features – Pneumatics

Basic valves VUVG

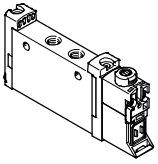

- Valve size 10 mm, 14 mm and 18 mm
- In-line valves and semi in-line valves
- Sub-base valves
- 2x3/2-way, 5/2-way and 5/3-way valves

Electrical connection boxes (E-box)

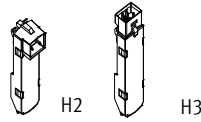

- 5, 12 and 24 V DC
- With or without holding current reduction
- LED

Basic valve and electrical connection box combinations

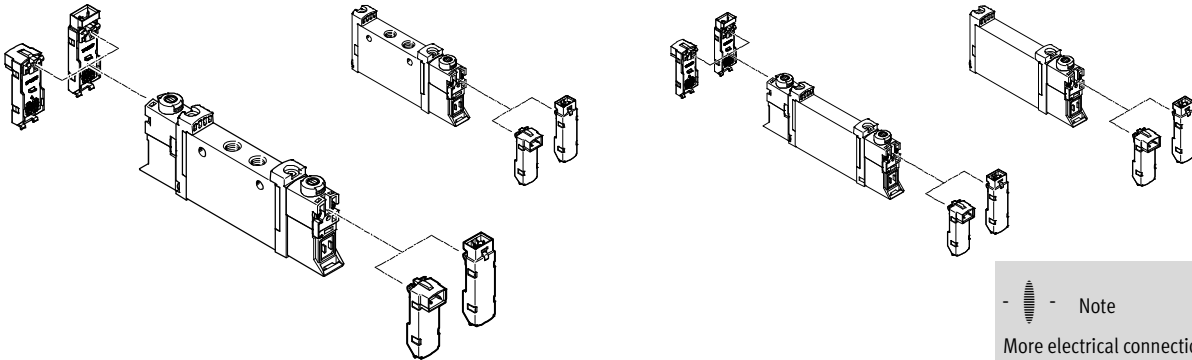

Note
 More electrical connection boxes
 → page 105

Cover caps for manual override

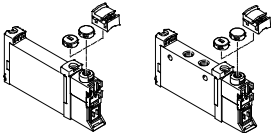

- Closed cover cap, covered manual override
- Slotted cover cap, non-detenting manual override
- Cover, detenting manual override

Inscription label holder

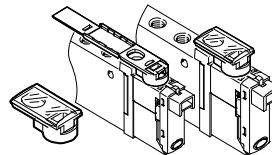

- The inscription label holder is mounted in the same way as a cover cap for manual override
- The hinged inscription label holder covers the mounting screw and the manual override

Solenoid valves VUVG

Key features – Pneumatics

FESTO

Manifold rail for in-line valves

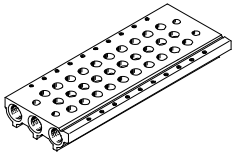

- For in-line valves M3, M5, M7, G1/8 and G1/4
- For 2x3/2-way, 5/2-way and 5/3-way valves
- 2 to 10 and 12, 14, 16 valve positions

Manifold rail for sub-base valves

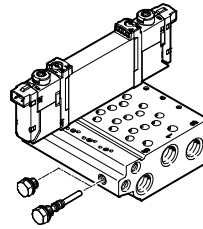

- For sub-base valves 10A, 10, 14 and 18
- Manifold rail with M5, M7, G1/8 and G1/4 working ports
- For 2x3/2-way, 5/2-way and 5/3-way valves
- 2 to 10, 12, 14 and 16 valve positions
- The sub-base valves always have external pilot air. The pilot air is set via the manifold rail. A short and a long blanking plug are included with the manifold rail for this purpose

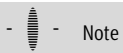

Note

Pressurisation and exhaust at both ends is recommended for an optimised flow rate in cases where multiple valves switch simultaneously.

Blanking plate for unused valve position



Vacant position cover

Supply plate



For additional air supply and exhaust via a valve position

Separator for pressure zones



For creating multiple pressure zones in a valve manifold

Solenoid valves VUVG

Key features – Pneumatics

Vertical pressure supply plate

For in-line valves M5/M7 and G1/8

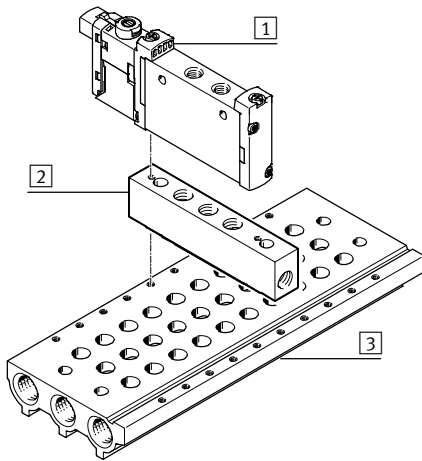

- 1 In-line valves VUVG
- 2 Vertical pressure supply plate
- 3 Manifold rail

The vertical pressure supply plate enables the valve to be pressurised and exhausted separately. If two vertical pressure supply plates are mounted one on top of the other, the valve can be supplied with compressed air and exhausted completely independently of the valve terminal (terminal code CS).

Code	Diagram	Type	For in-line valves		Description
			M5/M7	G1/8	
ZU		VABF-L1-P3A	■	■	Plate with port 1 for supplying an individual operating pressure or separate exhausting (reverse operation) for a valve position.
ZV		VABF-L1-P7A	■	■	Plate with ports 3 and 5 for exhausting the valve or supplying an individual operating pressure (reverse operation) for a valve position.

Solenoid valves VUVG

Key features – Pneumatics

Exhaust functions

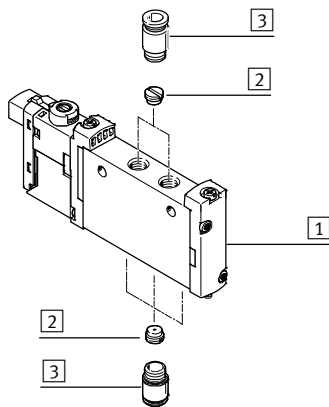

Flow restrictor for thread M5

In-line valve, individual electrical connection: flow restrictor can be fitted in port 1, 3, 5 and/or in port 2, 4.

Sub-base valve, individual electrical connection: flow restrictor can be fitted in port 2, 4.

Fixed flow restrictor, self-tapping

The fixed restrictor can be used to permanently set the exhaust flow rate in ducts 3 and 5.

The fixed restrictors are screwed into ducts 3 and 5 in the manifold rail.

Please see the relevant assembly instructions:

➔ www.festo.com/sp

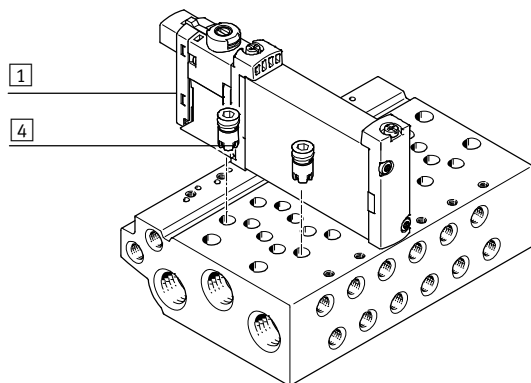

Check valve

Check valves prevent the unwanted switching of actuators by blocking flow towards the valves in the event of a backpressure that can develop in ducts 3 and 5 in the case of a high exhaust capacity.

The check valves are screwed into ducts 3 and 5 in the manifold rail. Please see the relevant assembly instructions:

➔ www.festo.com/sp

-  - Note

- It is not possible to use a check valve and a fixed restrictor (in the same duct) at the same time.
- When screwing in again, use the threads already present.

- 1 Valves VUVG with electrical individual connection
- 2 Flow restrictor for thread M5
- 3 Fitting
- 4 Fixed flow restrictor, self-tapping/check valve

Solenoid valves VUVG

Key features – Pneumatics

Creating pressure zones and separating exhaust air

Compressed air is supplied and exhausted via the manifold rail and via supply plates.
The position of the supply plates and duct separations can be freely selected with the VUVG.

Pressure zones are created by isolating the internal supply ducts between the manifold sub-bases by appropriate duct separation.

Pressure zone separation can be used for the following ducts:

- Duct 1
- Duct 3
- Duct 5

 Note

- Use a separator if the exhaust air pressures are high
- Use at least one supply plate/supply for each pressure zone
- Pressure zone separation is not possible in duct 12/14 (pilot air supply)

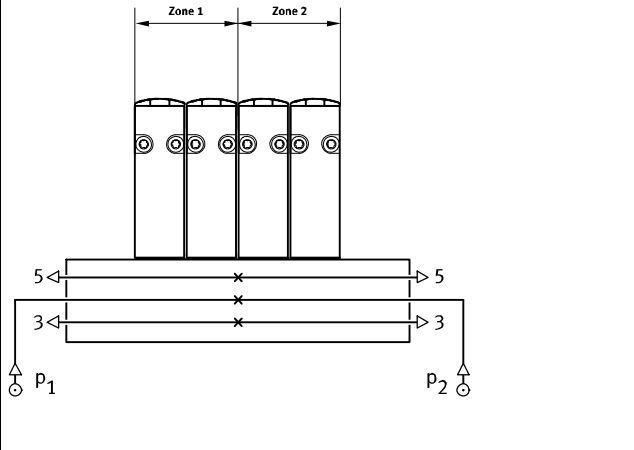
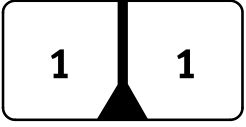
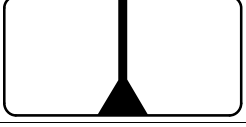
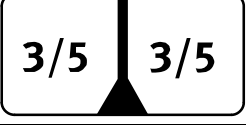
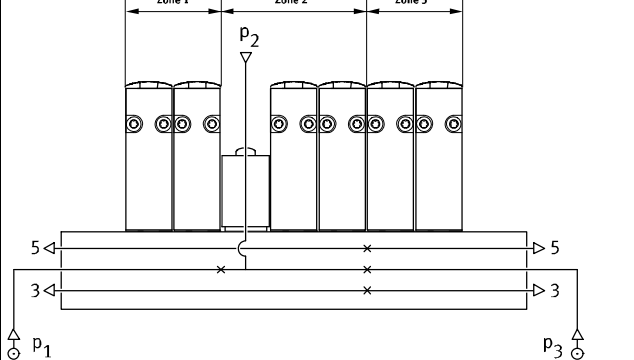
Duct separation	Description
	<p>The pressure zones can be freely configured with the VUVG. The following duct separations are possible:</p> <p>Duct 1 closed </p> <p>Duct 1, 3, 5 closed </p> <p>Duct 3, 5 closed </p>
	<p>The number of pressure zones with the VUVG is only limited by the number of valve positions on the manifold rail. Note that each supply plate occupies one valve position.</p>

Separator VABD

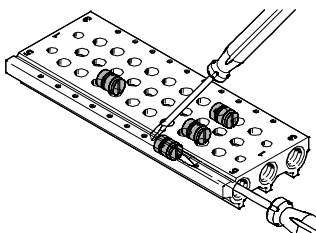

 Note

As the separators are fitted from only one side using a slotted screwdriver, several pressure zones can be created in one profile.

Solenoid valves VUVG

Key features – Pneumatics

Pilot air supply

Internal pilot air supply

Internal pilot air supply can be chosen with an operating pressure in the range 1.5 ... 8 bar, 2.5 ... 8 bar or 3 ... 8 bar (depending on the valve used).

The pilot air supply is branched from duct 1 (compressed air supply) using an internal connection.

External pilot air supply

External pilot air supply is required for vacuum operation. The port for external pilot air supply (port 12/14) is located on the valve in the case of in-line valves and on the manifold rail in the case of sub-base valves.

Pilot exhaust air

With in-line valves, the pilot exhaust air is vented via exhaust holes. With sub-base valves, the pilot exhaust air is vented via duct 82/84 of the manifold rail.

Pilot air supply with in-line and semi in-line valves

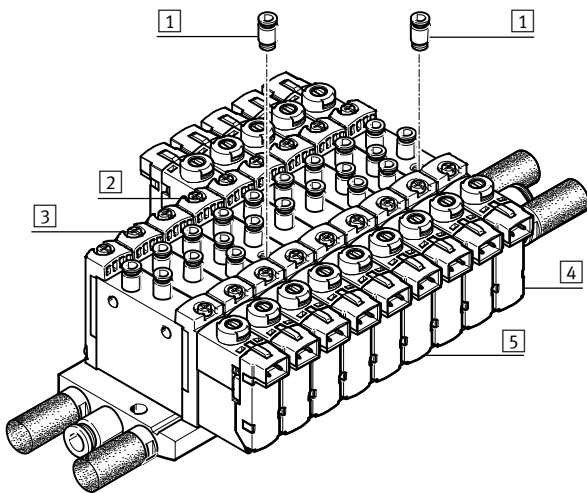

- 1 Push-in fitting for external pilot air supply at port 12/14
- 2 Single solenoid valve with external pilot air supply
- 3 Single solenoid valve with internal pilot air supply
- 4 Double solenoid valve with external pilot air supply
- 5 Double solenoid valve with internal pilot air supply

The internal pilot air is branched from port 1 in the valve body. The external pilot air (port 12/14) is supplied individually at each valve housing.

-  - Note
Semi in-line valves cannot be supplied centrally with pilot air via the manifold rail.

Pilot air supply with sub-base valves

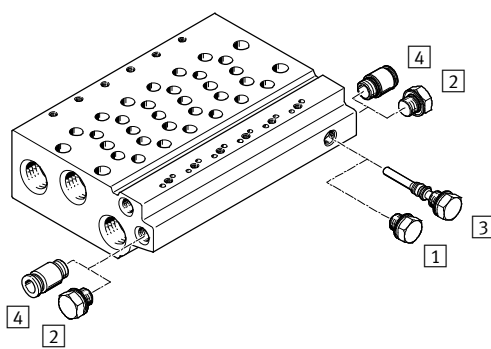

- 1 Short blanking plug with internal pilot air
- 2 Blanking plug for duct 12/14 with internal pilot air
- 3 Blanking plug, long, with external pilot air
- 4 Push-in fitting in duct 12/14 with external pilot air

The manifold rails for sub-base valves have an internal connection between duct 12/14 and duct 1. Internal or external pilot air supply is selected by inserting a blanking plug into this conduit.

Solenoid valves VUVG

Key features – Pneumatics

Operation with different pressures

Vacuum operation

Points to note with 3/2-way valves
The 3/2-way valves are available in a design with two valves in one valve body and with pneumatic spring return. With these valves, the force for the return movement is obtained from port 1.

Vacuum operation is therefore only possible at port 3 and 5, not at port 1.

With external pilot air supply, vacuum can be connected at port 1, 3, 5 of the 5/2-way and 5/3-way valves.

Reverse operation

The 3/2-way valves with pneumatic spring are not suitable for reverse operation, since at least the minimum pilot pressure must be present in duct 1.

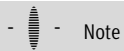

Note

Pressure must be present at port 1.

Pressure deflector (internal pilot air)

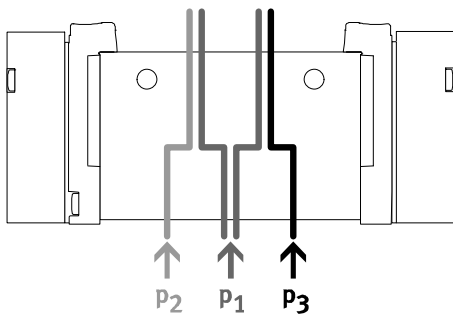

- If two different pressures are required.

- Different pressures can be supplied at duct 1, 3 and 5.



Note

- With internal pilot air supply, the minimum pilot pressure must be adhered to in duct 1

- With 2x3/2-way valves without spring return, the minimum pilot pressure must always be adhered to in duct 1

Benefits

Any pressure or vacuum can be connected at duct 3 and 5 both with external and internal pilot air

Vacuum, ejector pulse and normal position

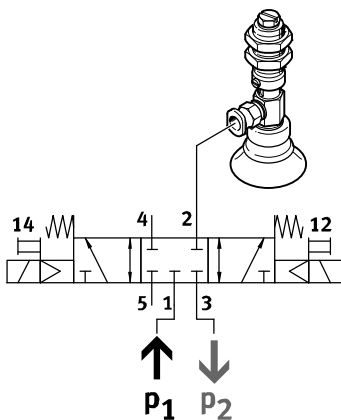

Vacuum, ejector pulse and normal position can be achieved as follows:

- Internal pilot air supply
- Vacuum in duct 3
- Pressure for the ejector pulse in duct 1

Solenoid valves VUVG

Product range overview

FESTO

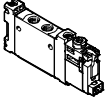
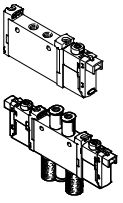
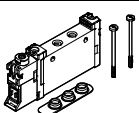
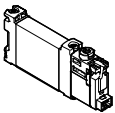
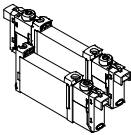
Design	Working port	Valve size	Functions and flow rate [l/min]												→ Page/ Internet
			T32C	T32U	T32H	T32C/M	T32U/M	T32H/M	M52	M52/M	B52	P53C	P53U	P53E	
In-line valve as individual valve, solenoid valve VUVG-LK															
	M5	10	■ 180	-	-	-	-	-	■ 195	-	■ 195	-	-	-	28
	M7	10	■ 280	-	-	-	-	-	■ 340	-	■ 340	-	-	-	32
	G1/8	14	■ 570	-	-	-	-	-	■ 660	-	■ 660	-	-	-	48
In-line valve as individual valve, solenoid valve VUVG-L															
	M3	10A	-	-	-	-	-	-	■ 100	■ 80	■ 100	■ 90	■ 90	■ 90	20
	M5	10	■ 150	■ 150	■ 150	■ 135	■ 125	■ 125	■ 220	■ 190	■ 220	■ 210	■ 210	■ 210	36
	M7	10	■ 190	■ 190	■ 190	■ 150	■ 140	■ 140	■ 380	■ 320	■ 380	■ 320	■ 320	■ 320	40
	G1/8	14	■ 650	■ 600	■ 650	■ 550	■ 500	■ 500	■ 780	■ 780	■ 780	■ 650	■ 600	■ 600	52
	G1/4	18	■ 1000	■ 1000	■ 1000	■ 1000	■ 1000	■ 1000	■ 1300	■ 1300	■ 1380	■ 1200	■ 1000	■ 1000	60
Semi in-line valve for manifold assembly, solenoid valve VUVG-S															
	M3	10A	-	-	-	-	-	-	■ 100	■ 80	■ 100	■ 90	■ 90	■ 90	20
	M5	10	■ 150	■ 150	■ 150	■ 135	■ 125	■ 125	■ 220	■ 190	■ 220	■ 210	■ 210	■ 210	36
	M7	10	■ 170	■ 170	■ 170	■ 140	■ 130	■ 130	■ 340	■ 290	■ 340	■ 300	■ 300	■ 300	40
	G1/8	14	■ 620	■ 580	■ 580	■ 520	■ 480	■ 480	■ 730	■ 730	■ 730	■ 620	■ 580	■ 580	52
	G1/4	18	■ 1000	■ 1000	■ 1000	■ 1000	■ 1000	■ 1000	■ 1300	■ 1300	■ 1380	■ 1200	■ 1000	■ 1000	60
Sub-base valve, solenoid valve VUVG-BK															
	M5	10	■ 160	-	-	-	-	-	■ 160	-	■ 160	-	-	-	75
	M7	10	■ 160	-	-	-	-	-	■ 160	-	■ 160	-	-	-	75
	G1/8	14	■ 350	-	-	-	-	-	■ 380	-	■ 380	-	-	-	86
Sub-base valve, solenoid valve VUVG-B															
	M3	10A	-	-	-	-	-	-	■ 100	■ 80	■ 100	■ 90	■ 90	■ 90	68
	M5	10	■ 150	■ 150	■ 150	■ 130	■ 120	■ 120	■ 210	■ 180	■ 210	■ 200	■ 200	■ 200	79
	M7	10	■ 160	■ 160	■ 160	■ 140	■ 130	■ 130	■ 270	■ 230	■ 270	■ 250	■ 250	■ 250	79
	G1/8	14	■ 540	■ 510	■ 540	■ 430	■ 410	■ 410	■ 580	■ 580	■ 580	■ 540	■ 510	■ 510	86
	G1/4	18	■ 800	■ 800	■ 800	■ 800	■ 800	■ 800	■ 1000	■ 1000	■ 1000	■ 950	■ 950	■ 950	97

Solenoid valves VUVG

Product range overview

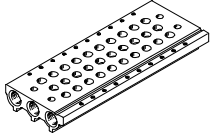
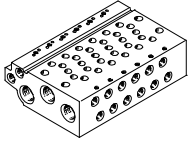

Design	Size	Description	→ Page/ Internet
Manifold rail VABM- ... -S- ..., for in-line valves (manifold assembly)			
	10AS	Size M3	26, 45, 57, 65
	10S	Size M5, M7	
	14S	Size G1/8	
	18S	Size G1/4	
Manifold rail VABM, for sub-base valves (manifold assembly)			
	10AW	Size M3	72, 84, 94, 101
	10W	Size M5	
	10HW	Size M7	
	14W	Size G1/8	
	18W	Size G1/4	

Solenoid valves VUVG

Overview of valve functions



Valve	Valve code	Description	Order code ¹⁾	VUVG-LK, VUVG-BK		VUVG-L, VUVG-B			
				Size		Size			
				M5/M7	G1/8	M3	M5/M7	G1/8	G1/4
2x 3/2-way valve, normally closed, pneumatic spring									
	T32C-A	In-line valve, internal pilot air supply	K	■	■	-	■	■	■
		In-line valve, external pilot air supply		-	-	-	■	■	-
		Sub-base valve, external pilot air supply		-	-	-	■	■	■
2x 3/2-way valve, normally open, pneumatic spring									
	T32U-A	In-line valve, internal pilot air supply	N	-	-	-	■	■	■
		In-line valve, external pilot air supply		-	-	-	■	■	-
		Sub-base valve, external pilot air supply		-	-	-	■	■	■
2x 3/2-way valve, 1x normally open, 1x normally closed, pneumatic spring									
	T32H-A	In-line valve, internal pilot air supply	H	-	-	-	■	■	■
		In-line valve, external pilot air supply		-	-	-	■	■	-
		Sub-base valve, external pilot air supply		-	-	-	■	■	■

1) Order code for valve terminal/position function

Solenoid valves VUVG

Overview of valve functions



Valve	Valve code	Description	Order code ¹⁾	VUVG-LK, VUVG-BK		VUVG-L, VUVG-B			
				Size		Size			
				M5/M7	G1/8	M3	M5/M7	G1/8	G1/4
2x3/2-way valve, normally closed, mechanical spring									
	T32C-M	In-line valve, internal pilot air supply	VK	-	-	-	■	■	■
		In-line valve, external pilot air supply		-	-	-	■	■	■
		Sub-base valve, external pilot air supply		-	-	-	■	■	■
2x3/2-way valve, normally open, mechanical spring									
	T32U-M	In-line valve, internal pilot air supply	VN	-	-	-	■	■	■
		In-line valve, external pilot air supply		-	-	-	■	■	■
		Sub-base valve, external pilot air supply		-	-	-	■	■	■
2x3/2-way valve, 1x normally open, 1x normally closed, mechanical spring									
	T32H-M	In-line valve, internal pilot air supply	VH	-	-	-	■	■	■
		In-line valve, external pilot air supply		-	-	-	■	■	■
		Sub-base valve, external pilot air supply		-	-	-	■	■	■

1) Order code for valve terminal/position function

Solenoid valves VUVG

Overview of valve functions

Valve	Valve code	Description	Order code ¹⁾	VUVG-LK, VUVG-BK		VUVG-L, VUVG-B			
				Size		Size			
				M5/M7	G1/8	M3	M5/M7	G1/8	G1/4
5/2-way valve, double solenoid									
	B52	In-line valve, internal pilot air supply	J	■	■	■	■	■	■
		In-line valve, external pilot air supply		-	-	■	■	■	■
		Sub-base valve, external pilot air supply		-	-	■	■	■	■
5/2-way valve, single solenoid, pneumatic spring									
	M52-A	In-line valve, internal pilot air supply	M	■	■	-	-	■	-
		In-line valve, external pilot air supply		-	-	-	-	■	-
		Sub-base valve, external pilot air supply		-	-	-	-	■	-
5/2-way valve, single solenoid, mechanical spring									
	M52-M	In-line valve, internal pilot air supply	A	-	-	■	■	■	■
		In-line valve, external pilot air supply		-	-	■	■	■	■
		Sub-base valve, external pilot air supply		-	-	■	■	■	■
5/2-way valve, single solenoid, pneumatic/mechanical spring									
	M52-R	In-line valve, internal pilot air supply	P	-	-	■	■	-	■
		In-line valve, external pilot air supply		-	-	■	■	-	■
		Sub-base valve, external pilot air supply		-	-	■	■	-	■

1) Order code for valve terminal/position function

Solenoid valves VUVG

Overview of valve functions



Valve	Valve code	Description	Order code ¹⁾	VUVG-LK, VUVG-BK		VUVG-L, VUVG-B			
				Size		Size			
				M5/M7	G1/8	M3	M5/M7	G1/8	G1/4
5/3-way valve, mid-position closed									
	P53C	In-line valve, internal pilot air supply	G	-	-	■	■	■	■
		In-line valve, external pilot air supply		-	-	■	■	■	■
		Sub-base valve, external pilot air supply		-	-	■	■	■	■
5/3-way valve, mid-position pressurised									
	P53U	In-line valve, internal pilot air supply	B	-	-	■	■	■	■
		In-line valve, external pilot air supply		-	-	■	■	■	■
		Sub-base valve, external pilot air supply		-	-	■	■	■	■
5/3-way valve, mid-position exhausted									
	P53E	In-line valve, internal pilot air supply	E	-	-	■	■	■	■
		In-line valve, external pilot air supply		-	-	■	■	■	■
		Sub-base valve, external pilot air supply		-	-	■	■	■	■

1) Order code for valve terminal/position function

Solenoid valves VUVG

Sample system overview – In-line valves M5/M7

Manifold assembly

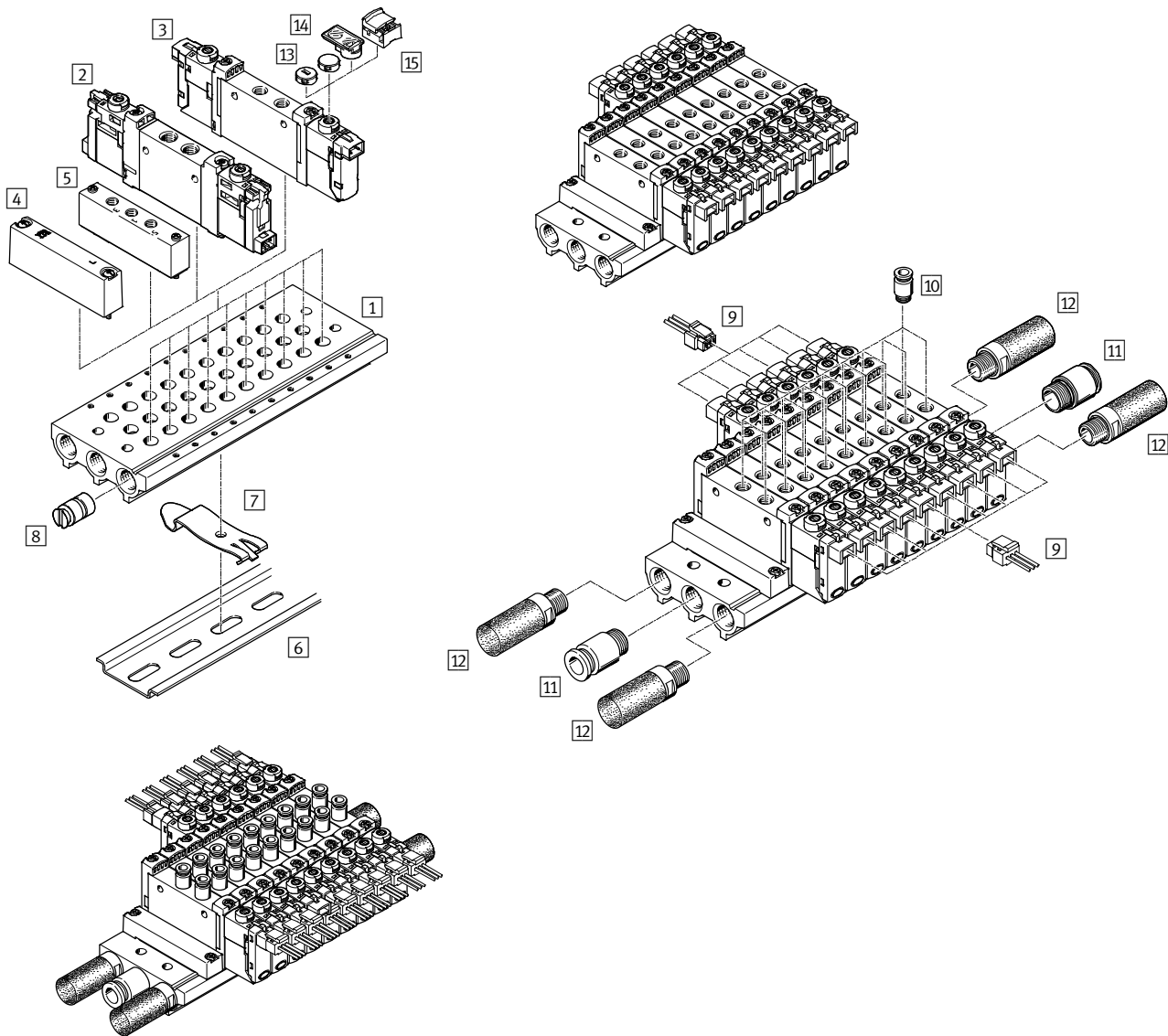

Manifold assembly and accessories

	Type	Description	→ Page/Internet	
1	Manifold rail	VABM-L1-10S-G18-...	For 2 to 10, 12, 14 and 16 valve positions	45
2	Solenoid valve	VUVG-LK ...	In-line valve 2x3/2-way, 5/2-way and 5/3-way	27
3	Solenoid valve	VUVG-L ...	In-line valve 2x3/2-way, 5/2-way and 5/3-way	27
4	Blanking plate	VABB-L1-10-S	For covering an unused valve position	45
5	Supply plate	VABF-L1-10-P3A4- ...	For air supply at duct 1 and duct 3 and 5	45
6	H-rail	NRH-35-2000	For mounting the valve manifold	110
7	H-rail mounting	VAME-T-M4	2 pieces for fitting the valve manifold on an H-rail	110
8	Separator	VABD-...	For creating pressure zones	45
9	Plug socket with cable	NEBV-H1G2-...-LE2	For electrical connection box H2 and H3	108
10	Push-in fitting	QS...	Push-in fitting for duct 2 and 4	109
11	Push-in fitting	QS...	Push-in fitting for air supply at duct 1	109
12	Silencer	U...	For duct 3 and 5	109
13	Cover cap	VMPA-HB...-B	For manual override	110
14	Inscription label holder	ASLR-D	For labelling the valves, covering the mounting screw and the manual override	110
15	Cover	VAMC	For manual override	110

Solenoid valves VUVG

Sample system overview, sub-base valves M5/M7





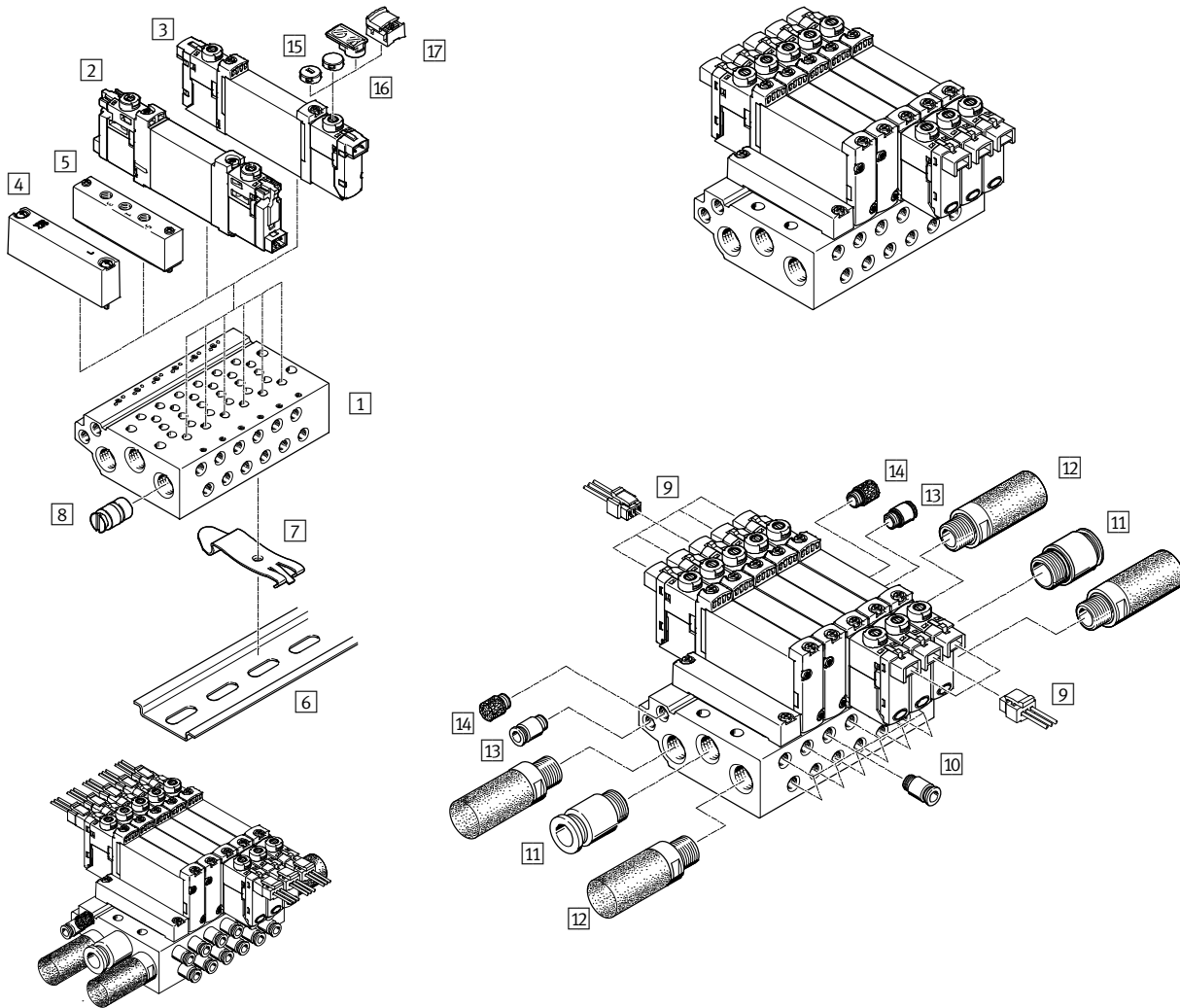

Manifold assembly

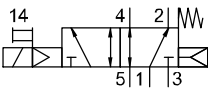
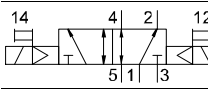
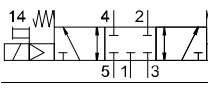
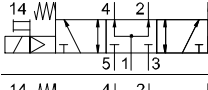
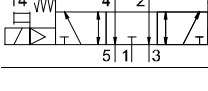

Manifold assembly and accessories				
	Type	Description	→ Page/Internet	
1	Manifold rail	VABM-L1-10 ...-G18- ...	For 2 to 10, 12, 14 and 16 valve positions	83
2	Solenoid valve	VUVG-BK ...	Sub-base valve 2x3/2-way, 5/2-way and 5/3-way	74
3	Solenoid valve	VUVG-B ...	Sub-base valve 2x3/2-way, 5/2-way and 5/3-way	74
4	Blanking plate	VABB-L1-10-W	For covering an unused valve position	84
5	Supply plate	VABF-L1-10-P3A4- ...	For air supply at duct 1 and duct 3 and 5	84
6	H-rail	NRH-35-2000	For mounting the valve manifold	110
7	H-rail mounting	VAME-T-M4	2 pieces for fitting the valve manifold on an H-rail	110
8	Separator	VABD- ...	For creating pressure zones	84
9	Plug socket with cable	NEBV-H1G2-KN-...-LE2	For electrical connection box H2 and H3	108
10	Push-in fitting	QS...	Push-in fitting for duct 2 and 4	109
11	Push-in fitting	QS...	Push-in fitting for air supply at duct 1	109
12	Silencer	U...	For duct 3 and 5	109
13	Push-in fitting	QS...	Push-in fitting for pilot air supply at duct 12/14	109
14	Silencer	U...	Silencer for pilot air exhaust at duct 82/84	109
15	Cover cap	VMPA-HB...-B	For manual override	110
16	Inscription label holder	ASLR-D	For labelling the valves, covering the mounting screw and the manual override	110
17	Cover	VAMC	For manual override	110

Solenoid valves VUVG, in line valves M3

Order code

VUVG	-	10A	-	-	-	-	-
Type of directional control valve							
In-line, individual valve	L						
Semi in-line, manifold valve incl. seal and screws	S						
Design principle							
Piston spool with sealing cartridge	-						
Valve size							
10 mm	10A						
Valve functions							
						M52	
						B52	
						P53C	
						P53U	
						P53E	
Reset method							
Mechanical spring with M52	M						
Pneumatic/mechanical spring with M52	R						
With B52 and P53	-						
Pilot air supply							
Internal	-						
External	Z						
Manual override							
 Non-detenting	H						
 Covered	S						
- Non-detenting, detenting	T						
 Detenting, without accessories	Y						

L	-						
Connecting cables							
W1...4	Not sheathed						
C1...4	Sheathed						
WS1...4	Not sheathed						
S1...4	Sheathed						
N1...4	M8x1, 3-pin						
N5...8	M8x1, 4-pin						
Display							
L	LED						
Protective circuit							
-	Without holding current reduction (HCR)						
R	With holding current reduction (HCR)						
Electrical connection box							
H2	Connection pattern H, horizontal plug connector						
H3	Connection pattern H, vertical plug connector						
S2	Connection pattern S, horizontal plug connector						
S3	Connection pattern S, vertical plug connector						
L1...4	With 2x flying leads L: 1 = 0.5 m, 2 = 1 m, 3 = 2.5 m, 4 = 5 m						
K6...9	Cable: K6 = 0.5 m, K7 = 1 m, K8 = 2.5 m, K9 = 5 m						
R1	Individual plug connector M8, 4-pin						
R8	Individual plug connector M8, 3-pin						
P3	Without electrical connection box						
Operating voltage							
1	24 V DC						
5	12 V DC						
4	5 V DC						
Exhausting with VUVG-L							
QN	Push-in fitting						
U	Silencer						
-	M3 thread						
Pneumatic connection							
M3	M3 thread						
T18	Push-in connector 1/8"						
T532	Push-in connector 5/32"						
Q3	Push-in connector 3 mm						
Q4	Push-in connector 4 mm						

Solenoid valves VUVG-L10A and VUVG-S10A, in-line valves M3



FESTO

Technical data

Function

- 5/2-way, single solenoid
- 5/2-way valve, double solenoid
- 5/3C, 5/3U, 5/3E

Circuit symbol → Page 13

-  - Valve size 10 mm
-  - Flow rate
90 ... 100 l/min
-  - Voltage
5, 12 and 24 V DC

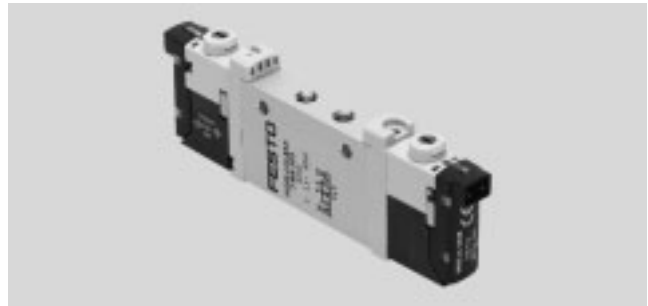

General technical data, VUVG-L M3						
Valve function	M52-R	B52	M52-M	P53		
Normal position	–	–	–	C ¹⁾	U ²⁾	E ³⁾
Stable position	Monostable	Bistable	Monostable	Monostable		
Reset method: pneumatic spring	Yes ⁴⁾	–	No	No		
Reset method: mechanical spring	Yes ⁴⁾	–	Yes	Yes		
Vacuum operation at port 1	Only with external pilot air supply					
Design	Piston spool					
Sealing principle	Soft					
Actuation type	Electrical					
Type of control	Piloted					
Pilot air supply	Internal or external					
Exhaust function	With flow control					
Manual override	Choice of non-detenting, covered, non-detenting/detenting or detenting					
Type of mounting	Optionally via through-holes ⁵⁾ or on manifold rail					
Mounting position	Any					
Nominal width [mm]	2		1.4	2		
Standard nominal flow rate [l/min]	100		80	90		
Flow rate on manifold rail [l/min]	100		80	90		
Switching time on/off [ms]	7/15	–	7/21	8/25		
Changeover time [ms]	–	5	–	14		
Valve size [mm]	10					
Port 1, 2, 3, 4, 5, 12/14	M3					
Product weight [g]	38	49	37			
Certification	c UL us - Recognized (OL)					
	c CSA us (OL)					
	RCM					
CE marking (see declaration of conformity) ⁶⁾	In accordance with EU EMC Directive					
Corrosion resistance class CRC ⁷⁾	2					

1) C=Normally closed/mid-position closed

2) U=Normally open/mid-position pressurised

3) E=Mid-position exhausted

4) Combined reset method

5) If several valves are to be screwed together via the through-holes to form a block, a minimum distance of 0.3 mm must be ensured by placing spacer discs between them.

6) For information about the applicability of the component see the manufacturer's EC declaration of conformity at: www.festo.com/sp → Certificates.

If the component is subject to restrictions on usage in residential, office or commercial environments or small businesses, further measures to reduce the emitted interference may be necessary.

7) Corrosion resistance class CRC 2 to Festo standard FN 940070

Moderate corrosion stress. Indoor applications in which condensation may occur. External visible parts with primarily decorative requirements for the surface and which are in direct contact with the ambient atmosphere typical for industrial applications.

Solenoid valves VUVG-L10A and VUVG-S10A, in-line valves M3

Technical data

Operating and environmental conditions					
Valve function		M52-R ¹⁾	B52	M52-M ²⁾	P53
Operating medium		Compressed air in accordance with ISO 8573-2010 [7:4:4]			
Operating pressure	Internal	[bar]	2.5 ... 8	1.5 ... 8	3 ... 8
	External	[bar]	-0.9 ... 10		-0.9 ... 8
Pilot pressure ³⁾		[bar]	2.5 ... 8	1.5 ... 8	3 ... 8
Ambient temperature		[°C]	-5 ... +50, with holding current reduction -5 ... +60		
Temperature of medium		[°C]	-5 ... +50, with holding current reduction -5 ... +60		

1) Mixed, pneumatic/mechanical spring

2) Mechanical spring

3) Minimum pilot pressure 50% of operating pressure

Electrical data	
Electrical connection	Via electrical connection box → Page 103
Operating voltage	[V DC] 5, 12 and 24 ±10%
Power	[W] 1, reduced to 0.35 with holding current reduction
Duty cycle	[%] 100
Degree of protection to EN 60529	IP40 (with plug socket), IP65 (with M8)

Information on materials	
Housing	Wrought aluminium alloy
Seals	HNBR, NBR
Note on materials	RoHS compliant

Solenoid valves VUVG-L10A and VUVG-S10A, in-line valves M3

Technical data

Dimensions

Download CAD data → www.festo.com

5/2-way and 5/3-way valve

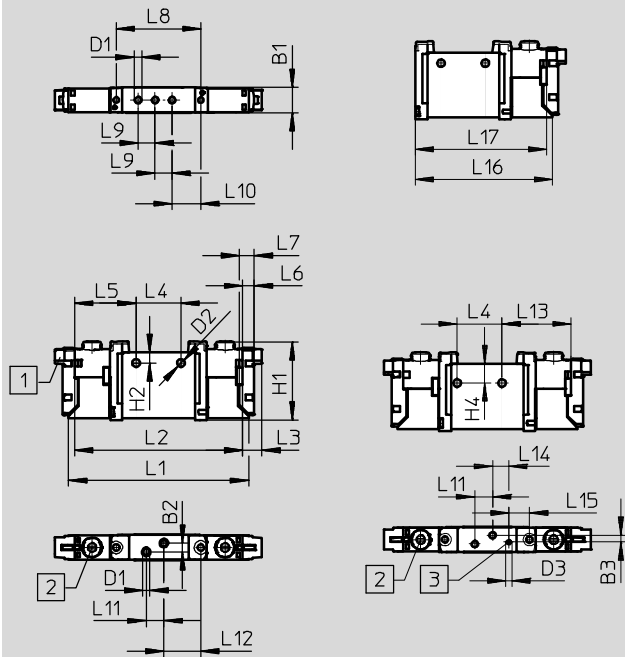

Note

More dimensions
Electrical connection boxes
→ Page 105

1 Electrical connection for solenoid valve, horizontal

2 Manual override

3 Connection for external pilot air supply

Type	B1	B2	B3	D1	D2	D3	H1	H2	L1	L2	L3	L4	L5
VUVG-L10A-...-M3...	10.2	3.6	2.83	M3	3.2	M3	32.5	4.4	74.3	69.3	8	18.5	25.4
VUVG-S10A-...-M3...													

Type	L6	L7	L8	L9	L10	L11	L12	L13	L14	L15	L16	L17
VUVG-L10A-...-M3...	4.85	6.15	34.9	7	11.9	7.3	15.25	28.5	6.7	8.54	57.06	54.56
VUVG-S10A-...-M3...												

Solenoid valves VUVG-L10A and VUVG-S10A, in-line valves M3

Ordering data

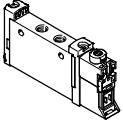
Ordering data				
	Description		Part No.	Type
In-line valve M3, without electrical connection box				
	5/2-way valve, single solenoid			
	Internal pilot air supply	Reset method: pneumatic/mechanical spring	566437	VUVG-L10A-M52-RT-M3-1P3
		Reset method: mechanical spring	574345	VUVG-L10A-M52-MT-M3-1P3
	External pilot air supply	Reset method: pneumatic/mechanical spring	566443	VUVG-L10A-M52-RZT-M3-1P3
		Reset method: mechanical spring	574346	VUVG-L10A-M52-MZT-M3-1P3
	5/2-way valve, double solenoid			
	Internal pilot air supply		566438	VUVG-L10A-B52-T-M3-1P3
	External pilot air supply		566444	VUVG-L10A-B52-ZT-M3-1P3
	5/3-way valve			
	Internal pilot air supply	Mid-position closed	566439	VUVG-L10A-P53C-T-M3-1P3
		Mid-position exhausted	566440	VUVG-L10A-P53E-T-M3-1P3
		Mid-position pressurised	566441	VUVG-L10A-P53U-T-M3-1P3
	External pilot air supply	Mid-position closed	566445	VUVG-L10A-P53C-ZT-M3-1P3
		Mid-position exhausted	566446	VUVG-L10A-P53E-ZT-M3-1P3
Mid-position pressurised		566447	VUVG-L10A-P53U-ZT-M3-1P3	

Solenoid valves VUVG-S10A, in-line valves M3

Manifold assembly



In-line valves for manifold assembly



Dimensions

Download CAD data → www.festo.com

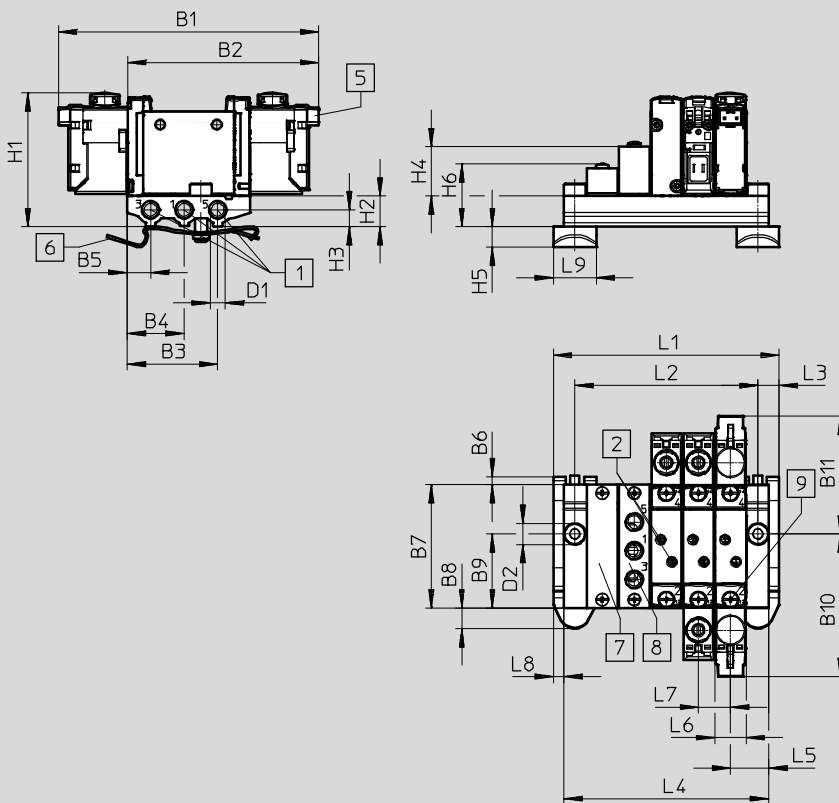

Note
 More dimensions
 Electrical connection boxes
 → Page 105

- 1** Ports 1, 3, 5
- 2** Ports 2 and 4
- 5** Electrical connection for electrical connection boxes and accessories
- 6** H-rail mounting (two M4x16 screws are required for mounting)
- 7** Blanking plate
- 8** Supply plate
- 9** Valves/blanking plate mounting on manifold rail

Type	B1	B2	B3	B4	B5	B6	B7	B8	B9	B10	B11	D1
VABM-L1-10AS-M5	85.3	62.6	29.7	18.7	7.7	3	40.3	6.8	24.2	46.7	38.6	M5

Type	D2	H1	H2	H3	H4	H5	H6	L3	L5	L6	L7	L8	L9
VABM-L1-10AS-M5	∅ 4.5	43.8	10	5.5	16.2	6.8	20.3	7	12.5	10.3	10.5	3.5	14

Valve positions	2	3	4	5	6	7	8	9	10	12	14	16
L1	42.5	53	63.5	74	84.5	95	105.5	116	126.5	147.5	168.5	189.5
L2	28.5	39	49.5	60	70.5	81	91.5	102	112.5	133.5	154.5	175.5
L4	35.5	46	56.5	67	77.5	88	98.5	109	119.5	140.5	161.5	182.5
VABM weight [g]	26	34	42	50	58	66	74	82	90	106	122	138

Solenoid valves VUVG-S10A, in-line valves M3

Ordering data

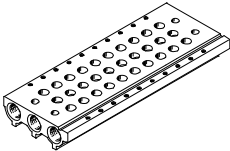
Technical data – Manifold rails							
	Port	CRC	Material ²⁾	Operating pressure [bar]	Max. tightening torque for assembly [Nm]		
	1, 3, 5				Valve	H-rail	Wall
	M5	2 ¹⁾	Wrought aluminium alloy	-0.9 ... 10	0.45	1.5	3

- 1) Corrosion resistance class CRC 2 to Festo standard FN 940070
Moderate corrosion stress. Indoor applications in which condensation may occur. External visible parts with primarily decorative requirements for the surface and which are in direct contact with the ambient atmosphere typical for industrial applications.
- 2) Note on materials: RoHS-compliant.





Order code – Manifold rails

VABM	-	L1	-	10A	S	-	M5	-	
Manifold assembly parts									Number of valve positions
Manifold rail		VABM							2 to 10, 12, 14 and 16
Valve series									Ports 1, 3, 5
VUVG		L1					M5		M5 thread
Valve size									
10 mm				10A					
Manifold rail with ports 1, 3, 5									
For in-line valves M3					S				

Solenoid valves VUVG-S10A, in-line valves M3

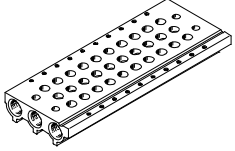

FESTO

Ordering data

Ordering data – Manifold rail			
	Description	Part No.	Type
Manifold rail for in-line valves (manifold assembly)			
	For size M3	2 valve positions	566522 VABM-L1-10AS-M5-2
		3 valve positions	566523 VABM-L1-10AS-M5-3
		4 valve positions	566524 VABM-L1-10AS-M5-4
		5 valve positions	566525 VABM-L1-10AS-M5-5
		6 valve positions	566526 VABM-L1-10AS-M5-6
		7 valve positions	566527 VABM-L1-10AS-M5-7
		8 valve positions	566528 VABM-L1-10AS-M5-8
		9 valve positions	566529 VABM-L1-10AS-M5-9
		10 valve positions	566530 VABM-L1-10AS-M5-10
		12 valve positions	566531 VABM-L1-10AS-M5-12
		14 valve positions	566532 VABM-L1-10AS-M5-14
16 valve positions	566533 VABM-L1-10AS-M5-16		
Blanking plate Technical data → Internet: vabf			
	For valve position on manifold rail, including screws and seal	569986	VABB-L1-10A
Separator Technical data → Internet: vabd			
	For creating pressure zones	570872	VABD-4.2-B
Supply plate Technical data → Internet: vabf			
	For valve position on manifold rail, including screws and seal	569990	VABF-L1-10A-P3A4-M5
Seals for in-line valves Technical data → Internet: vabd			
	For in-line valves M3	Delivery unit: 10 sets (each with 2 screws and 1 seal)	566670 VABD-L1-10AX-S-M3

Solenoid valves VUVG, in-line valves M5/M7

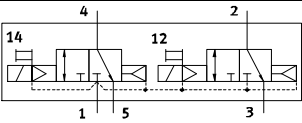
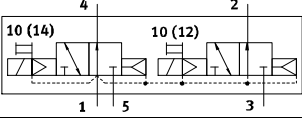
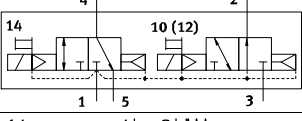
Order code

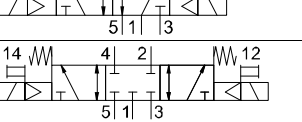
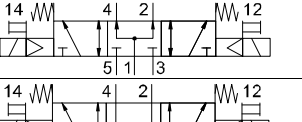
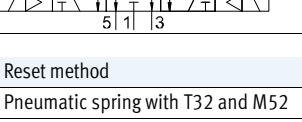
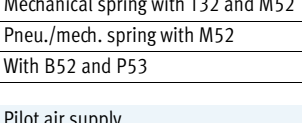

VUVG	-	10	-	-	-	-	-
Type of directional control valve							
In-line, individual valve		L					
Semi in-line, manifold valve, incl. seal and screws		S					
Design principle							
Piston spool with sealing cartridge		-					
Piston spool with sealing ring		K					
Valve size							
10 mm		10					
Valve functions							
							T32C
							T32U
							T32H
							M52
							B52
							P53C
							P53U
							P53E
Reset method							
Pneumatic spring with T32 and M52							A
Mechanical spring with T32 and M52							M
Pneu./mech. spring with M52							R
With B52 and P53							-
Pilot air supply							
Internal							-
External							Z
Manual override							
Non-detenting							H
Covered							S
Non-detenting, detenting							T
Detenting, without accessories							Y

							L	-	-
Version									
-									
Extended features									
S Core features									
Connecting cables									
W1...4		Not sheathed							
C1...4		Sheathed							
WS1...4		Not sheathed							
S1...4		Sheathed							
N1...4		M8x1, 3-pin							
N5...8		M8x1, 4-pin							
Display									
L LED									
Protective circuit									
-									
Without holding current reduction (HCR)									
R With holding current reduction (HCR)									
Electrical connection box									
H2		Connection pattern H, horizontal plug con.							
H3		Connection pattern H, vertical plug con.							
S2		Connection pattern S, horizontal plug con.							
S3		Connection pattern S, vertical plug con.							
L1...4		with 2x flying leads L: 1 = 0.5 m, 2 = 1 m, 3 = 2.5 m, 4 = 5 m							
K6...9		Cable: K6 = 0.5 m, K7 = 1 m, K8 = 2.5 m, K9 = 5 m							
R1		Individual plug connector M8, 4-pin							
R8		Individual plug connector M8, 3-pin							
P3		Without electrical connection box							
Operating voltage									
1		24 V DC							
5		12 V DC							
4		5 V DC							
Exhausting with VUVG-L									
QN		Push-in fitting							
U		Silencer							
-		Thread M5/M7							
Pneumatic connection									
M5		M5 thread							
M7		M7 thread							
Q3		Push-in connector 3 mm/M5							
Q4		Push-in connector 4 mm/M5							
Q4H		Push-in connector 4 mm/M7							
Q6		Push-in connector 6 mm/M5							
Q6H		Push-in connector 6 mm/M7							
T18		Push-in connector 1/8"							
T532		Push-in connector 5/32"							
T316		Push-in connector 3/16"							
T316H		Push-in connector 3/16", M7							
T14		Push-in connector 1/4"							
T14H		Push-in connector 1/4", M7							

Solenoid valves VUVG-LK10, in-line valves M5

Technical data

Function
 2x 3/2C
 5/2-way, single solenoid
 5/2-way, double solenoid valve

-  - Valve size 10 mm
-  - Flow rate
180 ... 195 l/min
-  - Voltage
24 V DC

Circuit symbol → Page 13



General technical data, VUVG-LK			
Valve function	T32-A	M52-A	B52
Normal position	C ¹⁾	–	–
Stable positions	Monostable		Bistable
Reset method: pneumatic spring	Yes	Yes	–
Design	Piston spool		
Sealing principle	Soft		
Actuation type	Electrical		
Type of control	Piloted		
Pilot air supply	Internal		
Exhaust air function	With flow control		
Manual override	Detenting, non-detenting		
Type of mounting	Optionally via through-holes ²⁾ or on manifold rail		
Mounting position	Any		
Standard nominal flow rate	[l/min] 180	195	195
Switching time on/off	[ms] 12/14	14/17	–
Changeover time	[ms] –		7
Valve size	[mm] 10		
Port	2, 4	M5	
Product weight	[g] 55	45	57
Corrosion resistance class CRC ³⁾	2		

1) C=Normally closed
 2) If several valves are to be screwed together via the through-holes to form a block, a minimum distance of 0.3 mm must be ensured by placing spacer discs between them.
 3) Corrosion resistance class CRC 2 to Festo standard FN 940070
 Moderate corrosion stress. Indoor applications in which condensation may occur. External visible parts with primarily decorative requirements for the surface and which are in direct contact with the ambient atmosphere typical for industrial applications.

Safety data	
Max. positive test pulse with 0 signal	[μs] 1600
Max. negative test pulse with 1 signal	[μs] 3000
Shock resistance	Shock test with severity level 1 to FN 942017-5 and EN 60068-2-27
Vibration resistance	Transport application test with severity level 1 to FN 942017-4 and EN 60068-2-6

Solenoid valves VUVG-LK10, in-line valves M5

Technical data

Operating and environmental conditions			
Valve function		T32-A ¹⁾	M52-A ¹⁾ B52
Operating medium		Compressed air in accordance with ISO 8573-2010 [7:4:4]	
Note on operating/pilot medium		Lubricated operation possible (in which case lubricated operation will always be required)	
Operating pressure	[bar]	1.5 ... 7	2.5 ... 7 1.5 ... 7
Ambient temperature	[°C]	-5 ... +50	
Temperature of medium	[°C]	-5 ... +50	

1) Pneumatic spring

Electrical data	
Electrical connection	Via electrical connection box → Page 103
Operating voltage	[V DC] 24 ±10%
Power	[W] 0.7
Duty cycle	[%] 100
Degree of protection to EN 60529	IP40 (with plug socket), IP65 (with M8)
Signal status display	LED
Maximum switching frequency	[Hz] 2

Information on materials	
Housing	Wrought aluminium alloy
Seals	HNBR, NBR
Note on materials	RoHS compliant Contains paint-wetting impairment substances

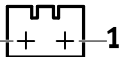
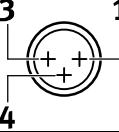
Pin allocation for electrical connection box			
	Pin		Description
Rectangular plug connector, plug pattern H			
	1	+ or -	Protective circuit without holding current reduction
	2	+ or -	
Round plug connector, M8, 3-pin			
	1	Not used	Protective circuit without holding current reduction
	3	+ or -	
	4	+ or -	

Protective circuit without holding current reduction

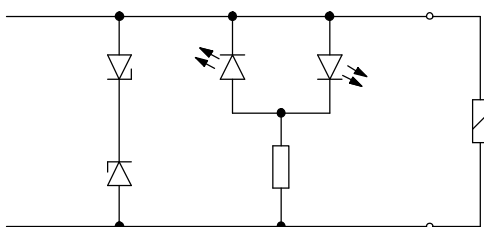

The solenoid coils are equipped with a protective circuit to arrest sparks and protect against polarity reversal.

Solenoid valves VUVG-LK10, in-line valves M5

Technical data

Dimensions

Download CAD data → www.festo.com

2x 3/2-way, 5/2-way valve, double solenoid

5/2 way valve, single solenoid

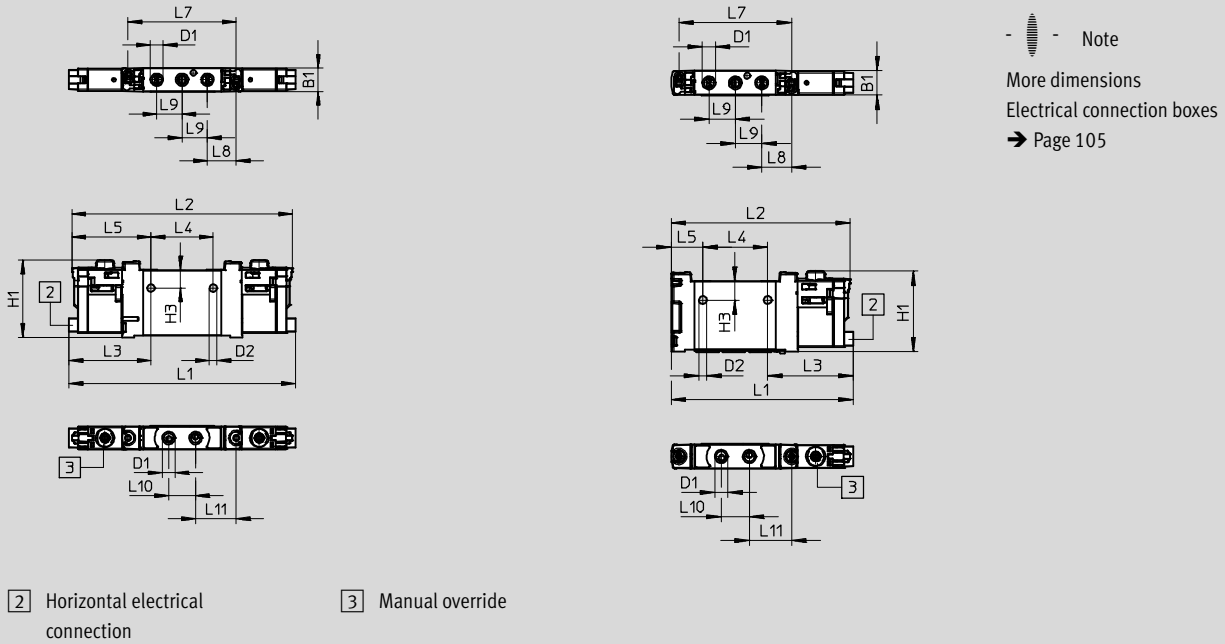

Type	B1	D1	D2	H1	H3	L1	L2	L3	L4
VUVG-LK10-T32C-...-M5...	10.2	M5	3.3	33.6	7.8	98.3	95.8	35.7	27
VUVG-LK10-B52-...-M5...						75.9	74.6		
VUVG-LK10-M52-...-M5...									

Type	L5	L7	L8	L9	L10	L11
VUVG-LK10-T32C-...-M5...	34.4	47	12.5	11	11.7	17.7
VUVG-LK10-B52-...-M5...						
VUVG-LK10-M52-...-M5...	13.2					

Solenoid valves VUVG-LK10, in-line valves M5

FESTO

Ordering data

★ Core product range

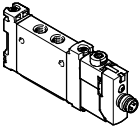
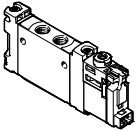
Ordering data				
	Description		Part No.	Type
In-line valve M5, with electrical connection box R8				
	2x 3/2-way valve			
	Internal pilot air supply	Normally closed, reset method: pneumatic spring	★ 8042542	VUVG-LK10-T32C-AT-M5-1R8L-S
	5/2-way valve, single solenoid			
	Internal pilot air supply	Reset method: pneumatic spring	★ 8042543	VUVG-LK10-M52-AT-M5-1R8L-S
5/2-way valve, double solenoid				
	Internal pilot air supply		★ 8042544	VUVG-LK10-B52-T-M5-1R8L-S
In-line valve M5, with electrical connection box H2				
	2x 3/2-way valve			
	Internal pilot air supply	Normally closed, reset method: pneumatic spring	★ 8042538	VUVG-LK10-T32C-AT-M5-1H2L-S
	5/2-way valve, single solenoid			
	Internal pilot air supply	Reset method: pneumatic spring	★ 8042539	VUVG-LK10-M52-AT-M5-1H2L-S
5/2-way valve, double solenoid				
	Internal pilot air supply		★ 8042540	VUVG-LK10-B52-T-M5-1H2L-S



Festo core product range

- ★ Ready for dispatch from the Festo factory in 24 hours
- ☆ Ready for dispatch in 5 days maximum from stock

Solenoid valves VUVG-LK10, in-line valves M7

Technical data

Function
 2x 3/2C
 5/2-way, single solenoid
 5/2-way, double solenoid valve

-  - Valve size 10 mm
-  - Flow rate
280 ... 340 l/min
-  - Voltage
24 V DC

Circuit symbol → Page 13



General technical data, VUVG-LK			
Valve function	T32-A	M52-A	B52
Normal position	C ¹⁾	-	-
Stable positions	Monostable		Bistable
Reset method: pneumatic spring	Yes	Yes	-
Design	Piston spool		
Sealing principle	Soft		
Actuation type	Electrical		
Type of control	Piloted		
Pilot air supply	Internal		
Exhaust air function	With flow control		
Manual override	Detenting, non-detenting		
Type of mounting	Optionally via through-holes ²⁾ or on manifold rail		
Mounting position	Any		
Standard nominal flow rate	[l/min] 280	340	340
Switching time on/off	[ms] 12/14	14/17	-
Changeover time	[ms] -		7
Valve size	[mm] 10		
Port	2, 4	M7	
Product weight	[g] 55	45	57
Corrosion resistance class CRC ³⁾	2		

1) C=Normally closed
 2) If several valves are to be screwed together via the through-holes to form a block, a minimum distance of 0.3 mm must be ensured by placing spacer discs between them.
 3) Corrosion resistance class CRC 2 to Festo standard FN 940070
 Moderate corrosion stress. Indoor applications in which condensation may occur. External visible parts with primarily decorative requirements for the surface and which are in direct contact with the ambient atmosphere typical for industrial applications.

Safety data	
Max. positive test pulse with 0 signal	[μs] 1600
Max. negative test pulse with 1 signal	[μs] 3000
Shock resistance	Shock test with severity level 1 to FN 942017-5 and EN 60068-2-27
Vibration resistance	Transport application test with severity level 1 to FN 942017-4 and EN 60068-2-6

Solenoid valves VUVG-LK10, in-line valves M7

Technical data

Operating and environmental conditions				
Valve function		T32-A ¹⁾	M52-A ¹⁾	B52
Operating medium	Compressed air in accordance with ISO 8573-2010 [7:4:4]			
Note on operating/pilot medium	Lubricated operation possible (in which case lubricated operation will always be required)			
Operating pressure	[bar]	1.5 ... 7	2.5 ... 7	1.5 ... 7
Ambient temperature	[°C]	-5 ... +50		
Temperature of medium	[°C]	-5 ... +50		

1) Pneumatic spring

Electrical data	
Electrical connection	Via electrical connection box → Page 103
Operating voltage	[V DC] 24 ±10%
Power	[W] 0.7
Duty cycle	[%] 100
Degree of protection to EN 60529	IP40 (with plug socket), IP65 (with M8)
Signal status display	LED
Maximum switching frequency	[Hz] 2

Information on materials	
Housing	Wrought aluminium alloy
Seals	HNBR, NBR
Note on materials	RoHS compliant
	Contains paint-wetting impairment substances

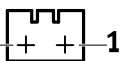
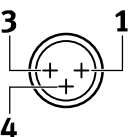
Pin allocation for electrical connection box			
	Pin		Description
Rectangular plug connector, plug pattern H			
	1	+ or -	Protective circuit without holding current reduction
	2	+ or -	
Round plug connector, M8, 3-pin			
	1	Not used	Protective circuit without holding current reduction
	3	+ or -	
	4	+ or -	

Protective circuit without holding current reduction

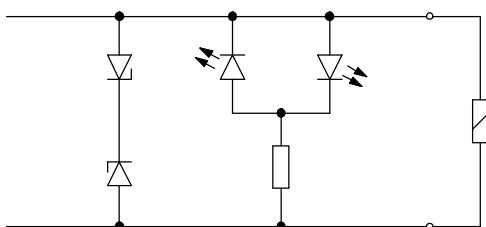

The solenoid coils are equipped with a protective circuit to arrest sparks and protect against polarity reversal.

Solenoid valves VUVG-LK10, in-line valves M7

Technical data

Dimensions Download CAD data → www.festo.com

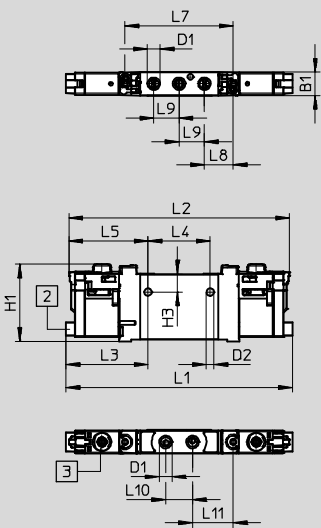
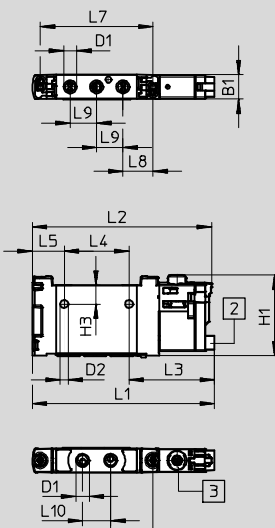
<p>2x 3/2-way, 5/2-way valve, double solenoid</p> 	<p>5/2 way valve, single solenoid</p> 	<p>Note More dimensions Electrical connection boxes → Page 105</p>
<p>2 Horizontal electrical connection</p>	<p>3 Manual override</p>	

Type	B1	D1	D2	H1	H3	L1	L2	L3	L4
VUVG-LK10-T32C-...-M7...	10.2	M7	3.3	33.6	7.8	98.3	95.8	35.7	27
VUVG-LK10-B52-...-M7...						75.9	74.6	35.7	
VUVG-LK10-M52-...-M7...									

Type	L5	L7	L8	L9	L10	L11
VUVG-LK10-T32C-...-M7...	34.4	47	12.5	11	11.7	17.7
VUVG-LK10-B52-...-M7...						
VUVG-LK10-M52-...-M7...	13.2					

Solenoid valves VUVG-LK10, in-line valves M7

Ordering data

★ Core product range

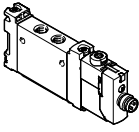
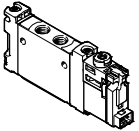
Ordering data				
		Description	Part No.	Type
In-line valve M7, with electrical connection box R8				
	2x 3/2-way valve			
	Internal pilot air supply	Normally closed, reset method: pneumatic spring	★ 8042550	VUVG-LK10-T32C-AT-M7-1R8L-S
	5/2-way valve, single solenoid			
	Internal pilot air supply	Reset method: pneumatic spring	★ 8042551	VUVG-LK10-M52-AT-M7-1R8L-S
	5/2-way valve, double solenoid			
	Internal pilot air supply		★ 8042552	VUVG-LK10-B52-T-M7-1R8L-S
In-line valve M7, with electrical connection box H2				
	2x 3/2-way valve			
	Internal pilot air supply	Normally closed, reset method: pneumatic spring	★ 8042546	VUVG-LK10-T32C-AT-M7-1H2L-S
	5/2-way valve, single solenoid			
	Internal pilot air supply	Reset method: pneumatic spring	★ 8042547	VUVG-LK10-M52-AT-M7-1H2L-S
	5/2-way valve, double solenoid			
	Internal pilot air supply		★ 8042548	VUVG-LK10-B52-T-M7-1H2L-S

Festo core product range

- ★ Ready for dispatch from the Festo factory in 24 hours
- ☆ Ready for dispatch in 5 days maximum from stock

Solenoid valves VUVG-L10 and VUVG-S10, in-line valves M5



Technical data

Function

2x 3/2C, 2x 3/2U, 2x 3/2H
 5/2-way, single solenoid
 5/2-way, double solenoid
 5/3C, 5/3U, 5/3E

Circuit symbol → Page 13

- - Valve size 10 mm
- - Flow rate
125 ... 220 l/min
- - Voltage
5, 12 and 24 V DC

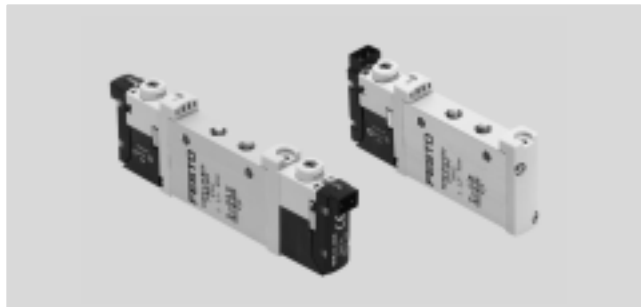

General technical data, VUVG-L M5													
Valve function	T32-A			T32-M			M52-R	B52	M52-M	P53			
Normal position	C ¹⁾	U ²⁾	H ⁴⁾	C ¹⁾	U ²⁾	H ⁴⁾	-	-	-	C ¹⁾	U ²⁾	E ³⁾	
Stable position	Monostable							Bistable	Monostable	Monostable			
Reset method: pneumatic spring	Yes			No			Yes ⁵⁾	-	No	-			
Reset method: mechanical spring	No			Yes			Yes ⁵⁾	-	Yes	-			
Vacuum operation at port 1	No			Only with external pilot air supply									
Design	Piston spool												
Sealing principle	Soft												
Actuation type	Electrical												
Type of control	Pilot												
Pilot air supply	Internal or external												
Exhaust function	With flow control												
Manual override	Choice of non-detenting, covered, non-detenting/detenting or detenting												
Type of mounting	Optionally via through-holes ⁶⁾ or on manifold rail												
Mounting position	Any												
Nominal width [mm]	2.7			1.9		1.8		3.2		2.2		3.2	
Standard nominal flow rate [l/min]	150			135		125		220		190		210	
Flow rate on manifold rail [l/min]	150			135		125		220		190		210	
Switching time on/off [ms]	6/16			8/11			7/19		-		8/24		10/30
Changeover time [ms]	-							7		-		16	
Valve size [mm]	10												
Port	1, 2, 3, 4, 5			M5									
	12/14			M3									
Product weight [g]	55			54			45		55		44		55
Certification	c UL us - Recognized (OL)												
	c CSA us (OL)												
	RCM												
CE marking (see declaration of conformity) ⁷⁾	In accordance with EU EMC Directive												
Corrosion resistance class CRC ⁸⁾	2												

- 1) C=Normally closed/mid-position closed
- 2) U=Normally open/mid-position pressurised
- 3) E=Mid-position exhausted
- 4) H=2x 3/2-way valve in one housing with 1x normally closed and 1x normally open
- 5) Combined reset method
- 6) If several valves are to be screwed together via the through-holes to form a block, a minimum distance of 0.3 mm must be ensured by placing spacer discs between them.
- 7) For information about the applicability of the component see the manufacturer's EC declaration of conformity at: www.festo.com/sp → Certificates.
If the component is subject to restrictions on usage in residential, office or commercial environments or small businesses, further measures to reduce the emitted interference may be necessary.
- 8) Corrosion resistance class CRC 2 to Festo standard FN 940070
Moderate corrosion stress. Indoor applications in which condensation may occur. External visible parts with primarily decorative requirements for the surface and which are in direct contact with the ambient atmosphere typical for industrial applications.

Solenoid valves VUVG-L10 and VUVG-S10, in-line valves M5

Technical data

Operating and environmental conditions									
Valve function			T32-A ¹⁾	T32-M ³⁾	M52-R ²⁾	B52	M52-M ³⁾	P53	
Operating medium			Compressed air in accordance with ISO 8573-2010 [7:4:4]						
Operating pressure	Internal	[bar]	1.5 ... 8	2.5 ... 8	2.5 ... 8	1.5 ... 8	3 ... 8	3 ... 8	
	External	[bar]	1.5 ... 10	-0.9 ... 10			-0.9 ... 8	-0.9 ... 10	
Pilot pressure ⁴⁾		[bar]	1.5 ... 8	2 ... 8	2.5 ... 8	1.5 ... 8	3 ... 8		
Ambient temperature		[°C]	-5 ... +50, with holding current reduction -5 ... +60						
Temperature of medium		[°C]	-5 ... +50, with holding current reduction -5 ... +60						

- 1) Pneumatic spring
- 2) Mixed, pneumatic/mechanical spring
- 3) Mechanical spring
- 4) Minimum pilot pressure 50% of operating pressure

Electrical data	
Electrical connection	Via electrical connection box → Page 103
Operating voltage	[V DC] 5, 12 and 24 ±10%
Power	[W] 1, reduced to 0.35 with holding current reduction
Duty cycle	[%] 100
Degree of protection to EN 60529	IP40 (with plug socket), IP65 (with M8)

Information on materials	
Housing	Wrought aluminium alloy
Seals	HNBR, NBR
Note on materials	RoHS compliant

Dimensions Download CAD data → www.festo.com

2x 3/2-way, 5/2-way and 5/3-way valve

⌀ - Note
More dimensions
Electrical connection boxes
→ Page 105

1 Vertical electrical connection

2 Horizontal electrical connection

3 Manual override

4 Port for external pilot air supply

Type	B1	B2	D1	D2	D3	H1	H2	H3	L1	L2	L3	L4
VUVG-L-10 -...-M5...	10.2	-	M5	3.2	M3	32.5	3.6	4.4	86.5	81.5	8	27
VUVG-S-10 -...-M5...												

Type	L5	L6	L7	L8	L9	L10	L11	L12	L13	L14
VUVG-L-10 -...-M5...	4.85	6.15	47	14	11	12	19	-	69.2	66.7
VUVG-S-10 -...-M5...										

Solenoid valves VUVG-L10 and VUVG-S10, in-line valves M5

FESTO

Ordering data

★ Core product range

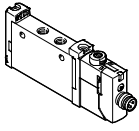
Ordering data			
	Description	Part No.	Type
In-line valve M5, with electrical connection box R8			
	2x 3/2-way valve		
	Internal pilot air supply	Normally closed, reset method: pneumatic spring	★ 577347 VUVG-L10-T32C-AT-M5-1R8L
	5/2-way valve, single solenoid		
	Internal pilot air supply	Reset method: pneumatic/mechanical spring	★ 572634 VUVG-L10-M52-RT-M5-1R8L
	5/2-way valve, double solenoid		
	Internal pilot air supply		★ 576664 VUVG-L10-B52-T-M5-1R8L
	5/3-way valve		
Internal pilot air supply	Mid-position closed	★ 577346 VUVG-L10-P53C-T-M5-1R8L	

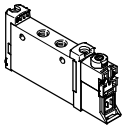
Ordering data			
	Description	Part No.	Type
In-line valve M5, without electrical connection box			
	2x 3/2-way valve		
	Internal pilot air supply	Normally closed, reset method: pneumatic spring	566454 VUVG-L10-T32C-AT-M5-1P3
		Normally open, reset method: pneumatic spring	566455 VUVG-L10-T32U-AT-M5-1P3
		1x normally open, 1x normally closed, reset method: pneumatic spring	566456 VUVG-L10-T32H-AT-M5-1P3
		Normally closed, reset method: mechanical spring	574348 VUVG-L10-T32C-MT-M5-1P3
		Normally open, reset method: mechanical spring	574349 VUVG-L10-T32U-MT-M5-1P3
		1x normally open, 1x normally closed, reset method: mechanical spring	574350 VUVG-L10-T32H-MT-M5-1P3
	External pilot air supply	Normally closed, reset method: pneumatic spring	566463 VUVG-L10-T32C-AZT-M5-1P3
		Normally open, reset method: pneumatic spring	566464 VUVG-L10-T32U-AZT-M5-1P3
		1x normally open, 1x normally closed, reset method: pneumatic spring	566465 VUVG-L10-T32H-AZT-M5-1P3
		Normally closed, reset method: mechanical spring	574352 VUVG-L10-T32C-MZT-M5-1P3
		Normally open, reset method: mechanical spring	574353 VUVG-L10-T32U-MZT-M5-1P3
		1x normally open, 1x normally closed, reset method: mechanical spring	574354 VUVG-L10-T32H-MZT-M5-1P3
	5/2-way valve, single solenoid		
	Internal pilot air supply	Reset method: pneumatic/mechanical spring	566457 VUVG-L10-M52-RT-M5-1P3
		Reset method: mechanical spring	574351 VUVG-L10-M52-MT-M5-1P3
	External pilot air supply	Reset method: pneumatic/mechanical spring	566466 VUVG-L10-M52-RZT-M5-1P3
		Reset method: mechanical spring	574355 VUVG-L10-M52-MZT-M5-1P3

Festo core product range

- ★ Ready for dispatch from the Festo factory in 24 hours
- ☆ Ready for dispatch in 5 days maximum from stock

Solenoid valves VUVG-L10 and VUVG-S10, in-line valves M5

Ordering data

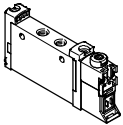
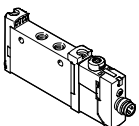
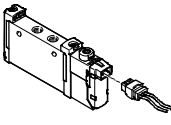
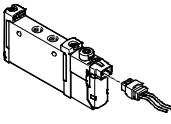
Ordering data					
	Description		Part No.	Type	
In-line valve M5, without electrical connection box					
	5/2-way valve, double solenoid				
	Internal pilot air supply		566458	VUVG-L10-B52-T-M5-1P3	
	External pilot air supply		566467	VUVG-L10-B52-ZT-M5-1P3	
	5/3-way valve				
	Internal pilot air supply	Mid-position closed		566459	VUVG-L10-P53C-T-M5-1P3
		Mid-position exhausted		566460	VUVG-L10-P53E-T-M5-1P3
		Mid-position pressurised		566461	VUVG-L10-P53U-T-M5-1P3
	External pilot air supply	Mid-position closed		566468	VUVG-L10-P53C-ZT-M5-1P3
		Mid-position exhausted		566469	VUVG-L10-P53E-ZT-M5-1P3
Mid-position pressurised			566470	VUVG-L10-P53U-ZT-M5-1P3	
In-line valve M5, with electrical connection box R8					
	2x 3/2-way valve				
	Internal pilot air supply	Normally open, reset method: pneumatic spring		8031466	VUVG-L10-T32U-AT-M5-1R8L
		1x normally open, 1x normally closed, reset method: pneumatic spring		8031467	VUVG-L10-T32H-AT-M5-1R8L
		Normally closed, reset method: mechanical spring		8031468	VUVG-L10-T32C-MT-M5-1R8L
		Normally open, reset method: mechanical spring		8031469	VUVG-L10-T32U-MT-M5-1R8L
		1x normally open, 1x normally closed, reset method: mechanical spring		8031470	VUVG-L10-T32H-MT-M5-1R8L
	5/2-way valve, single solenoid				
	Internal pilot air supply	Reset method: mechanical spring		8031472	VUVG-L10-M52-MT-M5-1R8L
	5/3-way valve				
	Internal pilot air supply	Mid-position exhausted		8031475	VUVG-L10-P53E-T-M5-1R8L
		Mid-position pressurised		8031476	VUVG-L10-P53U-T-M5-1R8L
In-line valve M5, with electrical connection box H2					
	5/2-way valve, single solenoid				
	Internal pilot air supply	Reset method: pneumatic/mechanical spring		577316	VUVG-L10-M52-RT-M5-1H2L-W1
		Reset method: mechanical spring		578162	VUVG-L10-M52-MT-M5-1H2L-W1
	5/2-way valve, double solenoid				
Internal pilot air supply		577317	VUVG-L10-B52-T-M5-1H2L-W1		
Semi in-line valve M5, with electrical connection box H2					
	5/2-way valve, single solenoid				
	Internal pilot air supply	Reset method: pneumatic/mechanical spring		577324	VUVG-S10-M52-RT-M5-1H2L-W1



Solenoid valves VUVG-L10 and VUVG-S10, in-line valves M7

Technical data

Function

2x 3/2C, 2x 3/2U, 2x 3/2H
 5/2-way, single solenoid
 5/2-way, double solenoid
 5/3C, 5/3U, 5/3E

Circuit symbol → Page 13

-  - Valve size 10 mm
-  - Flow rate
170 ... 340 l/min
-  - Voltage
5, 12 and 24 V DC

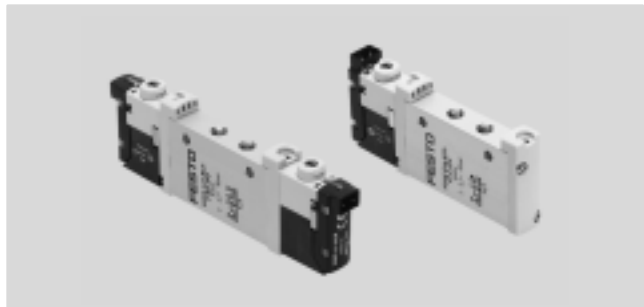

General technical data, VUVG-L M7												
Valve function	T32-A			T32-M			M52-R	B52	M52-M	P53		
Normal position	C ¹⁾	U ²⁾	H ⁴⁾	C ¹⁾	U ²⁾	H ⁴⁾	-	-	-	C ¹⁾	U ²⁾	E ³⁾
Stable position	Monostable							Bistable	Monostable	Monostable		
Reset method: pneumatic spring	Yes			No			Yes ⁵⁾	-	No	-		
Reset method: mechanical spring	No			Yes			Yes ⁵⁾	-	Yes	-		
Vacuum operation at port 1	No			Only with external pilot air supply								
Design	Piston spool											
Sealing principle	Soft											
Actuation type	Electrical											
Type of control	Pilot											
Pilot air supply	Internal or external											
Exhaust function	With flow control											
Manual override	Choice of non-detenting, covered, non-detenting/detenting or detenting											
Type of mounting	Optionally via through-holes ⁶⁾ or on manifold rail											
Mounting position	Any											
Nominal width [mm]	2.7			2.0		1.9		4.0		2.8		3.5
Standard nominal flow rate [l/min]	190			150		140		380		320		320
Flow rate on manifold rail [l/min]	170			140		130		340		290		300
Switching time on/off [ms]	6/16			8/11			7/19		-		8/24	10/30
Changeover time [ms]	-							7		-		16
Valve size [mm]	10											
Port	1, 2, 3, 4, 5			M7								
	12/14			M3								
Product weight [g]	55			54			45		55	44		55
Certification	c UL us - Recognized (OL)											
	c CSA us (OL)											
	RCM											
CE marking (see declaration of conformity) ⁷⁾	In accordance with EU EMC Directive											
Corrosion resistance class CRC ⁸⁾	2											

1) C=Normally closed/mid-position closed
 2) U=Normally open/mid-position pressurised
 3) E=Mid-position exhausted
 4) H=2x 3/2-way valve in one housing with 1x normally closed and 1x normally open
 5) Combined reset method
 6) If several valves are to be screwed together via the through-holes to form a block, a minimum distance of 0.3 mm must be ensured by placing spacer discs between them.
 7) For information about the applicability of the component see the manufacturer's EC declaration of conformity at: www.festo.com/sp → Certificates.
 If the component is subject to restrictions on usage in residential, office or commercial environments or small businesses, further measures to reduce the emitted interference may be necessary.
 8) Corrosion resistance class CRC 2 to Festo standard FN 940070
 Moderate corrosion stress. Indoor applications in which condensation may occur. External visible parts with primarily decorative requirements for the surface and which are in direct contact with the ambient atmosphere typical for industrial applications.

Solenoid valves VUVG-L10 and VUVG-S10, in-line valves M7

Technical data

Operating and environmental conditions			T32-A ¹⁾	T32-M ³⁾	M52-R ²⁾	B52	M52-M ³⁾	P53
Valve function			Compressed air in accordance with ISO 8573-2010 [7:4:4]					
Operating pressure	Internal	[bar]	1.5 ... 8	2.5 ... 8	2.5 ... 8	1.5 ... 8	3 ... 8	
	External	[bar]	1.5 ... 10	-0.9 ... 10			-0.9 ... 8	-0.9 ... 10
Pilot pressure ⁴⁾		[bar]	1.5 ... 8	2 ... 8	2.5 ... 8	1.5 ... 8	3 ... 8	3 ... 8
Ambient temperature		[°C]	-5 ... +50, with holding current reduction -5 ... +60					
Temperature of medium		[°C]	-5 ... +50, with holding current reduction -5 ... +60					

- 1) Pneumatic spring
- 2) Mixed, pneumatic/mechanical spring
- 3) Mechanical spring
- 4) Minimum pilot pressure 50% of operating pressure

Electrical data	
Electrical connection	Via electrical connection box → Page 103
Operating voltage	[V DC] 5, 12, 24 ±10%
Power	[W] 1, reduced to 0.35 with holding current reduction
Duty cycle	[%] 100
Degree of protection to EN 60529	IP40 (with plug socket), IP65 (with M8)

Information on materials	
Housing	Wrought aluminium alloy
Seals	HNBR, NBR
Note on materials	RoHS compliant

Dimensions Download CAD data → www.festo.com

2x 3/2-way, 5/2-way and 5/3-way valve

Note
More dimensions
Electrical connection boxes
→ Page 105

1 Vertical electrical connection

2 Horizontal electrical connection

3 Manual override

4 Port for external pilot air supply

Type	B1	B2	D1	D2	D3	H1	H2	H3	L1	L2	L3	L4
VUVG-L-10 -...-M7...	10.2	-	M7	3.2	M3	32.5	3.6	4.4	86.5	81.5	8	27
VUVG-S-10 -...-M7...												

Type	L5	L6	L7	L8	L9	L10	L11	L12	L13	L14
VUVG-L-10 -...-M7...	4.85	6.15	47	14	11	12	19	-	69.2	66.7
VUVG-S-10 -...-M7...										

Solenoid valves VUVG-L10 and VUVG-S10, in-line valves M7

FESTO

Ordering data

★ Core product range

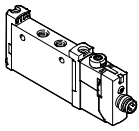
Ordering data			
	Description	Part No.	Type
In-line valve M7, with electrical connection box R8			
	2x 3/2-way valve		
	Internal pilot air supply	Normally closed, reset method: pneumatic spring	★ 574218 VUVG-L10-T32C-AT-M7-1R8L
	5/2-way valve, single solenoid		
	Internal pilot air supply	Reset method: pneumatic/mechanical spring	★ 574221 VUVG-L10-M52-RT-M7-1R8L
	5/2-way valve, double solenoid		
	Internal pilot air supply		★ 574222 VUVG-L10-B52-T-M7-1R8L
	5/3-way valve		
Internal pilot air supply	Mid-position closed	★ 574223 VUVG-L10-P53C-T-M7-1R8L	

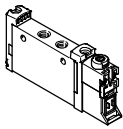
Ordering data			
	Description	Part No.	Type
In-line valve M7, without electrical connection box			
	2x 3/2-way valve		
	Internal pilot air supply	Normally closed, reset method: pneumatic spring	566471 VUVG-L10-T32C-AT-M7-1P3
		Normally open, reset method: pneumatic spring	566472 VUVG-L10-T32U-AT-M7-1P3
		1x normally open, 1x normally closed, reset method: pneumatic spring	566473 VUVG-L10-T32H-AT-M7-1P3
		Normally closed, reset method: mechanical spring	574356 VUVG-L10-T32C-MT-M7-1P3
		Normally open, reset method: mechanical spring	574357 VUVG-L10-T32U-MT-M7-1P3
		1x normally open, 1x normally closed, reset method: mechanical spring	574358 VUVG-L10-T32H-MT-M7-1P3
	External pilot air supply	Normally closed, reset method: pneumatic spring	566479 VUVG-L10-T32C-AZT-M7-1P3
		Normally open, reset method: pneumatic spring	566480 VUVG-L10-T32U-AZT-M7-1P3
		1x normally open, 1x normally closed, reset method: pneumatic spring	566481 VUVG-L10-T32H-AZT-M7-1P3
		Normally closed, reset method: mechanical spring	574360 VUVG-L10-T32C-MZT-M7-1P3
		Normally open, reset method: mechanical spring	574361 VUVG-L10-T32U-MZT-M7-1P3
		Normally closed, reset method: mechanical spring	574362 VUVG-L10-T32H-MZT-M7-1P3

Festo core product range

★ Ready for dispatch from the Festo factory in 24 hours

☆ Ready for dispatch in 5 days maximum from stock

Solenoid valves VUVG-L10 and VUVG-S10, in-line valves M7

Ordering data

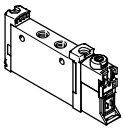
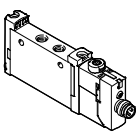
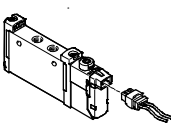
Ordering data				
	Description		Part No.	Type
In-line valve M7, without electrical connection box				
	5/2-way valve, single solenoid			
	Internal pilot air supply	Reset method: mechanical spring	574359	VUVG-L10-M52-MT-M7-1P3
		Reset method: pneumatic/mechanical spring	566474	VUVG-L10-M52-RT-M7-1P3
	External pilot air supply	Reset method: mechanical spring	574363	VUVG-L10-M52-MZT-M7-1P3
		Reset method: pneumatic/mechanical spring	566482	VUVG-L10-M52-RZT-M7-1P3
	5/2-way valve, double solenoid			
	Internal pilot air supply		566475	VUVG-L10-B52-T-M7-1P3
	External pilot air supply		566483	VUVG-L10-B52-ZT-M7-1P3
	5/3-way valve			
	Internal pilot air supply	Mid-position closed	566476	VUVG-L10-P53C-T-M7-1P3
		Mid-position exhausted	566477	VUVG-L10-P53E-T-M7-1P3
		Mid-position pressurised	566478	VUVG-L10-P53U-T-M7-1P3
	External pilot air supply	Mid-position closed	566484	VUVG-L10-P53C-ZT-M7-1P3
		Mid-position exhausted	566485	VUVG-L10-P53E-ZT-M7-1P3
Mid-position pressurised		566486	VUVG-L10-P53U-ZT-M7-1P3	
In-line valve M7, with electrical connection box R8				
	2x 3/2-way valve			
	Internal pilot air supply	Normally open, reset method: pneumatic spring	574219	VUVG-L10-T32U-AT-M7-1R8L
		1x normally open, 1x normally closed, reset method: pneumatic spring	574220	VUVG-L10-T32H-AT-M7-1R8L
		Normally closed, reset method: mechanical spring	8031480	VUVG-L10-T32C-MT-M7-1R8L
		Normally open, reset method: mechanical spring	8031481	VUVG-L10-T32U-MT-M7-1R8L
		1x normally open, 1x normally closed, reset method: mechanical spring	8031482	VUVG-L10-T32H-MT-M7-1R8L
	5/2-way valve, single solenoid			
	Internal pilot air supply	Reset method: mechanical spring	8031485	VUVG-L10-M52-MT-M7-1R8L
	5/3-way valve			
	Internal pilot air supply	Mid-position exhausted	574225	VUVG-L10-P53E-T-M7-1R8L
		Mid-position pressurised	574224	VUVG-L10-P53U-T-M7-1R8L
In-line valve M7, with electrical connection box H2				
	5/2-way valve, single solenoid			
	Internal pilot air supply	Reset method: pneumatic/mechanical spring	577333	VUVG-L10-M52-RT-M7-1H2L-W1
		Reset method: mechanical spring	578163	VUVG-L10-M52-MT-M7-1H2L-W1
	5/2-way valve, double solenoid			
Internal pilot air supply		577332	VUVG-L10-B52-T-M7-1H2L-W1	

Solenoid valves VUVG-S10, in-line valves M5/M7

Manifold assembly



In-line valves for manifold assembly



Dimensions

Download CAD data → www.festo.com

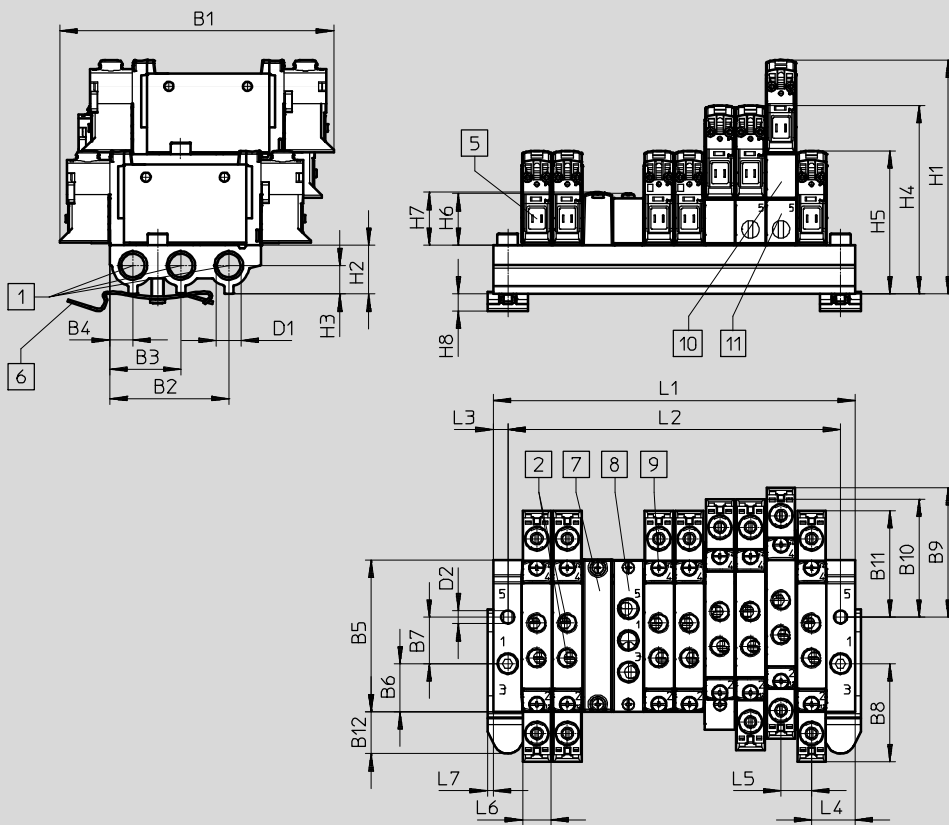

Note
 More dimensions
 Electrical connection boxes
 → Page 105

- 1 Ports 1, 3 and 5
- 2 Ports 2 and 4
- 3 Electrical connection for electrical connection boxes and accessories
- 4 H-rail mounting (two M4x20 screws are required for mounting)
- 5 Blanking plate
- 6 Supply plate
- 7 Valves/blanking plate mounting on manifold rail
- 8 Vertical pressure supply plate
- 9 Vertical pressure exhaust plate

Type	B1	B2	B3	B4	B5	B6	B7	B8	B9	B10	B11	B12
VABML-L1-10S-G18	94.3	41	24.5	8	52.1	16.5	16	33.7	44.6	40.7	36.7	14.4

Type	D1	D2	D5	H1	H2	H3	H4	H5	H6	H7	H8	L3	L4	L5	L6	L7
VABML-L1-10S-G18	G1/8	4.5	8	80.6	16.8	9.8	64.9	49.3	17.8	18	5.9	5	15	10.5	10.3	2

Solenoid valves VUVG-S10, in-line valves M5/M7

Ordering data

Valve positions	2	3	4	5	6	7	8	9	10	12	14	16	22
L1	40.5	51	61.5	72	82.5	93	103.5	114	124.5	145.5	166.5	187.5	250.5
L2	30.5	41	51.5	62	72.5	83	93.5	104	114.5	135.5	156.5	177.5	240.5
VABM weight [g]	63	78	93	108	123	138	153	168	183	213	243	273	363

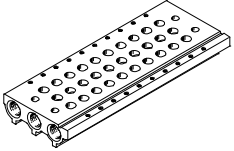
Technical data – Manifold rails							
	Port	CRC	Material ²⁾	Operating pressure [bar]	Max. tightening torque for assembly [Nm]		
	1, 3, 5				Valve	H-rail	Wall
	G1/8	2 ¹⁾	Wrought aluminium alloy	-0.9 ... 10	0.45	1.5	3

- Corrosion resistance class CRC 2 to Festo standard FN 940070
Moderate corrosion stress. Indoor applications in which condensation may occur. External visible parts with primarily decorative requirements for the surface and which are in direct contact with the ambient atmosphere typical for industrial applications.
- Note on materials: RoHS-compliant.

Order code – Manifold rails

VABM	-	L1	-	10	S	-	G18	-	
Manifold assembly parts									
Manifold rail		VABM							
Valve series									
VUVG		L1							
Valve size									
10 mm				10					
Manifold rail with ports 1, 3, 5									
For M5 and M7 in-line valves					S				

Number of valve positions	2 to 10, 12, 14 and 16
Ports 1, 3, 5	G18 G1/8 thread

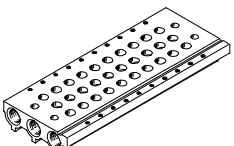
Ordering data – Manifold rail			
	Description	Part No.	Type
	For size M5/M7	2 valve positions	★ 566558 VABM-L1-10S-G18-2
		3 valve positions	★ 566559 VABM-L1-10S-G18-3
		4 valve positions	★ 566560 VABM-L1-10S-G18-4
		5 valve positions	566561 VABM-L1-10S-G18-5
		6 valve positions	★ 566562 VABM-L1-10S-G18-6
		7 valve positions	566563 VABM-L1-10S-G18-7
		8 valve positions	★ 566564 VABM-L1-10S-G18-8
		9 valve positions	566565 VABM-L1-10S-G18-9
		10 valve positions	★ 566566 VABM-L1-10S-G18-10
		12 valve positions	566567 VABM-L1-10S-G18-12
		14 valve positions	566568 VABM-L1-10S-G18-14
16 valve positions	566569 VABM-L1-10S-G18-16		







Festo core product range

- ★ Ready for dispatch from the Festo factory in 24 hours
- ☆ Ready for dispatch in 5 days maximum from stock

Solenoid valves VUVG-S10, in-line valves M5/M7

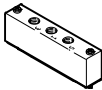
FESTO

Ordering data

Ordering data – Accessories			
	Description	Part No.	Type
Blanking plate Technical data → Internet: vabb			
	For valve position on manifold rail, including screws and seal	★ 566462	VABB-L1-10-S
Separator Technical data → Internet: vabd			
	For creating pressure zones	569995	VABD-8-B
Supply plate Technical data → Internet: vabf			
	For valve position (in-line valves M5) on manifold rail, including screws and seal	569991	VABF-L1-10-P3A4-M5
	For valve position (in-line valves M7) on manifold rail, including screws and seal	569992	VABF-L1-10-P3A4-M7
Seals Technical data → Internet: vabd			
	In-line valves VUVG-LK		
	For M5 in-line valves	Delivery unit: 10 sets (each with 2 screws and 1 seal)	★ 8043718 VABD-L1-10XK-S-M5-S
	For M7 in-line valves		★ 8043719 VABD-L1-10XK-S-M7-S
	In-line valves VUVG-L		
For M5 in-line valves	Delivery unit: 10 sets (each with 2 screws and 1 seal)	★ 566672 VABD-L1-10X-S-M5	
For M7 in-line valves		★ 566673 VABD-L1-10X-S-M7	
Vertical pressure supply plate			
	Pneumatic connection 1: M7	Terminal code CP	574592 VABF-L1-P3A3-M7
Vertical exhaust plate			
	Pneumatic connection 3, 5: M7	Terminal code CR	574594 VABF-L1-P7A13-M7

Festo core product range

- ★ Ready for dispatch from the Festo factory in 24 hours
- ☆ Ready for dispatch in 5 days maximum from stock

Solenoid valves VUVG, in-line valve G1/8

Order code

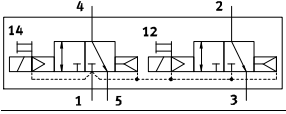
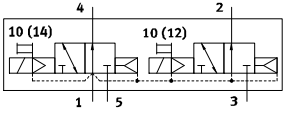
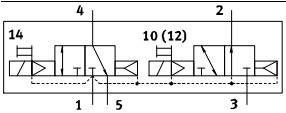
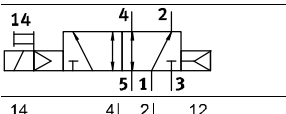
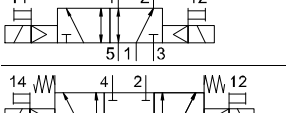
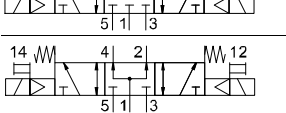
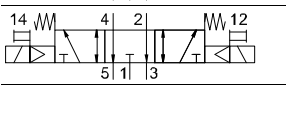
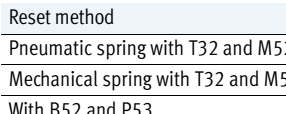

VUVG	-	14	-	-	-	-	-
Type of directional control valve							
In-line, individual valve	L						
Semi in-line, manifold valve incl. seal and screw	S						
Design principle							
Piston spool with sealing cartridge	-						
Piston spool with sealing ring	K						
Valve size							
14 mm		14					
Valve functions							
							T32C
							T32U
							T32H
							M52
							B52
							P53C
							P53U
							P53E
Reset method							
Pneumatic spring with T32 and M52							A
Mechanical spring with T32 and M52							M
With B52 and P53							-
Pilot air supply							
Internal							-
External							Z
Manual override							
Non-detenting							H
Covered							S
Non-detenting, detenting							T
Detenting, without accessories							Y

								L	-	-	-	-
Version												
-												
Extended features												
S Core features												
Connecting cables												
W1...4		Not sheathed										
C1...4		Sheathed										
WS1...4		Not sheathed										
S1...4		Sheathed										
N1...4		M8x1, 3-pin										
N5...8		M8x1, 4-pin										
Display												
L LED												
Protective circuit												
-												
Without holding current reduction (HCR)												
R With holding current reduction (HCR)												
Electrical connection box												
H2		Connection pattern H, horizontal plug connector										
H3		Connection pattern H, vertical plug connector										
S2		Connection pattern S, horizontal plug connector										
S3		Connection pattern S, vertical plug connector										
L1...4		with 2x flying leads L: 1 = 0.5 m, 2 = 1 m, 3 = 2.5 m, 4 = 5 m										
K6...9		Cable: K6 = 0.5 m, K7 = 1 m, K8 = 2.5 m, K9 = 5 m										
R1		Individual plug connector M8, 4-pin										
R8		Individual plug connector M8, 3-pin										
P3		Without electrical connection box										
Operating voltage												
1		24 V DC										
5		12 V DC										
4		5 V DC										
Exhausting with VUVG-L												
QN		Push-in fitting										
U		Silencer										
-		G1/8 thread										
Pneumatic connection												
G18		G1/8 thread										
T14		Push-in connector 1/4"										
T516		Push-in connector 5/16"										
Q4		Push-in connector 4 mm										
Q6		Push-in connector 6 mm										
Q8		Push-in connector 8 mm										

Solenoid valves VUVG-LK14, in-line valves G1/8

Technical data

Function
 2x 3/2C
 5/2-way, single solenoid
 5/2-way, double solenoid valve

-  - Valve size 14 mm
-  - Flow rate
570 ... 660 l/min
-  - Voltage
24 V DC

Circuit symbol → Page 13



General technical data, VUVG-LK			
Valve function	T32-A	M52-A	B52
Normal position	C ¹⁾	-	-
Stable positions	Monostable		Bistable
Reset method: pneumatic spring	Yes	Yes	-
Design	Piston spool		
Sealing principle	Soft		
Actuation type	Electrical		
Type of control	Pilot		
Pilot air supply	Internal		
Exhaust air function	With flow control		
Manual override	Non-detenting, detenting		
Type of mounting	Optionally via through-holes ²⁾ or on manifold rail		
Mounting position	Any		
Standard nominal flow rate	[l/min] 570	660	660
Switching time on/off	[ms] 13/20	14/24	-
Changeover time	[ms] -		8
Valve size	[mm] 14		
Port	2, 4	G1/8	
Product weight	[g] 75	65	85
Corrosion resistance class CRC ³⁾	2		

1) C=Normally closed
 2) If several valves are to be screwed together via the through-holes to form a block, a minimum distance of 0.3 mm must be ensured by placing spacer discs between them.
 3) Corrosion resistance class CRC 2 to Festo standard FN 940070
 Moderate corrosion stress. Indoor applications in which condensation may occur. External visible parts with primarily decorative requirements for the surface and which are in direct contact with the ambient atmosphere typical for industrial applications.

Safety data	
Max. positive test pulse with 0 signal	[μs] 1600
Max. negative test pulse with 1 signal	[μs] 3000
Shock resistance	Shock test with severity level 1 to FN 942017-5 and EN 60068-2-27
Vibration resistance	Transport application test with severity level 1 to FN 942017-4 and EN 60068-2-6

Solenoid valves VUVG-LK14, in-line valves G1/8

Technical data

Operating and environmental conditions				
Valve function		T32-A ¹⁾	M52-A ¹⁾	B52
Operating medium	Compressed air in accordance with ISO 8573-2010 [7:4:4]			
Note on operating/pilot medium	Lubricated operation possible (in which case lubricated operation will always be required)			
Operating pressure	[bar]	1.5 ... 7	2.5 ... 7	1.5 ... 7
Ambient temperature	[°C]	-5 ... +50		
Temperature of medium	[°C]	-5 ... +50		

1) Pneumatic spring

Electrical data	
Electrical connection	Via electrical connection box → Page 103
Operating voltage	[V DC] 24 ±10%
Power	[W] 0.7
Duty cycle	[%] 100
Degree of protection to EN 60529	IP40 (with plug socket), IP65 (with M8)
Signal status display	LED
Maximum switching frequency	[Hz] 2

Information on materials	
Housing	Wrought aluminium alloy
Seals	HNBR, NBR
Note on materials	RoHS compliant
	Contains paint-wetting impairment substances

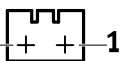
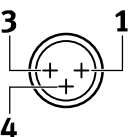
Pin allocation for electrical connection box			
	Pin		Description
Rectangular plug connector, plug pattern H			
	1	+ or -	Protective circuit without holding current reduction
	2	+ or -	
Round plug connector, M8, 3-pin			
	1	Not used	Protective circuit without holding current reduction
	3	+ or -	
	4	+ or -	

Protective circuit without holding current reduction

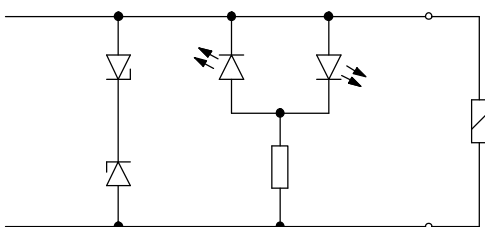

The solenoid coils are equipped with a protective circuit to arrest sparks and protect against polarity reversal.

Solenoid valves VUVG-LK14, in-line valves G1/8

Technical data

Dimensions Download CAD data → www.festo.com

2x 3/2-way, 5/2-way valve, double solenoid

5/2 way valve, single solenoid

Note
More dimensions
Electrical connection boxes
→ Page 105

2 Horizontal electrical connection 3 Manual override

Type	B1	D1	D2	H1	H3	L1	L2	L3	L4	L5
VUVG-LK14-T32C...-G18...	14.4	G1/8	3.3	34.8	3.2	118.9	116.4	41	37	39.7
VUVG-LK14-B52...-G18...										17.7
VUVG-LK14-M52...-G18...						95.6	94.4			

Type	L7	L8	L9	L10	L11
VUVG-LK14-T32C...-G18...	66.5	18.4	14.9	17	24.8
VUVG-LK14-B52...-G18...					
VUVG-LK14-M52...-G18...					

Solenoid valves VUVG-LK14, in-line valves G1/8

Ordering data

★ Core product range

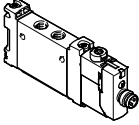
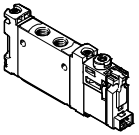
Ordering data				
	Description		Part No.	Type
In-line valve G1/8, with electrical connection box R8				
	2x 3/2-way valve			
	Internal pilot air supply	Normally closed, reset method: pneumatic spring	★ 8042566	VUVG-LK14-T32C-AT-G18-1R8L-S
	5/2-way valve, single solenoid			
	Internal pilot air supply	Reset method: pneumatic spring	★ 8042567	VUVG-LK14-M52-AT-G18-1R8L-S
	5/2-way valve, double solenoid			
	Internal pilot air supply		★ 8042568	VUVG-LK14-B52-T-G18-1R8L-S
In-line valve G1/8, with electrical connection box H2				
	2x 3/2-way valve			
	Internal pilot air supply	Normally closed, reset method: pneumatic spring	★ 8042562	VUVG-LK14-T32C-AT-G18-1H2L-S
	5/2-way valve, single solenoid			
	Internal pilot air supply	Reset method: pneumatic spring	★ 8042563	VUVG-LK14-M52-AT-G18-1H2L-S
	5/2-way valve, double solenoid			
	Internal pilot air supply		★ 8042564	VUVG-LK14-B52-T-G18-1H2L-S

Festo core product range

- ★ Ready for dispatch from the Festo factory in 24 hours
- ☆ Ready for dispatch in 5 days maximum from stock

Solenoid valves VUVG-L14 and VUVG-S14, in-line valves G1/8



FESTO

Technical data

Function

2x 3/2C, 2x 3/2U, 2x 3/2H
5/2-way, single solenoid
5/2-way, double solenoid
5/3C, 5/3U, 5/3E

Circuit symbol → Page 13

-  - Valve size 14 mm
-  - Flow rate
480 ... 730 l/min
-  - Voltage
5, 12 and 24 V DC



General technical data, VUVG-L G1/8													
Valve function	T32-A			T32-M			M52-A	B52	M52-M	P53			
Normal position	C ¹⁾	U ²⁾	H ⁴⁾	C ¹⁾	U ²⁾	C ¹⁾	–	–	–	C ¹⁾	U ²⁾	E ³⁾	
Stable position	Monostable							Bistable		Monostable			
Reset method: pneumatic spring	Yes			No			Yes	–	No	–			
Reset method: mechanical spring	No			Yes			No	–	Yes	–			
Vacuum operation at port 1	No			Only with external pilot air supply									
Design	Piston spool												
Sealing principle	Soft												
Actuation type	Electrical												
Type of control	Pilot												
Pilot air supply	Internal or external												
Exhaust function	With flow control												
Manual override	Choice of non-detenting, covered, non-detenting/detenting or detenting												
Type of mounting	Optionally via through-holes ⁵⁾ or on manifold rail												
Mounting position	Any												
Nominal width [mm]	4.6			4.3			5.6						
Standard nominal flow rate [l/min]	650	600	650	550	500	500	730	780		650	600		
Flow rate on manifold rail [l/min]	620	580		520	480	480	680	730		620	580		
Switching time on/off [ms]	8/23			11/15			14/22		–	13/35		12/40	
Changeover time [ms]	–							8		–	20		
Valve size [mm]	14												
Port	1, 2, 3, 4, 5			G1/8									
	12/14			M5									
Product weight [g]	89			80			78	89	70	89			
Certification	c UL us - Recognized (OL)												
	c CSA us (OL)												
	RCM												
CE marking (see declaration of conformity) ⁶⁾	In accordance with EU EMC Directive												
Corrosion resistance class CRC ⁷⁾	2												

1) C=Normally closed/mid-position closed

2) U=Normally open/mid-position pressurised

3) E=Mid-position exhausted

4) H=2x 3/2-way valve in one housing with 1x normally closed and 1x normally open

5) If several valves are to be screwed together via the through-holes to form a block, a minimum distance of 0.3 mm must be ensured by placing spacer discs between them.

6) For information about the applicability of the component see the manufacturer's EC declaration of conformity at: www.festo.com/sp → Certificates.

If the component is subject to restrictions on usage in residential, office or commercial environments or small businesses, further measures to reduce the emitted interference may be necessary.

7) Corrosion resistance class CRC 2 to Festo standard FN 940070

Moderate corrosion stress. Indoor applications in which condensation may occur. External visible parts with primarily decorative requirements for the surface and which are in direct contact with the ambient atmosphere typical for industrial applications.

Solenoid valves VUVG-L14 and VUVG-S14, in-line valves G1/8

Technical data

Operating and environmental conditions			T32-A ¹⁾	T32-M ²⁾	M52-A ¹⁾	B52	M52-M ²⁾	P53
Valve function			Compressed air in accordance with ISO 8573-2010 [7:4:4]					
Operating pressure	Internal	[bar]	1.5 ... 8	3.5 ... 8	2.5 ... 8	1.5 ... 8	3 ... 8	
	External	[bar]	1.5... 10	-0.9... 10			-0.9... 8	-0.9... 10
Pilot pressure ³⁾		[bar]	1.5 ... 8	2 ... 8	2.5 ... 8	1.5 ... 8	3 ... 8	
Ambient temperature		[°C]	-5 ... +50, with holding current reduction -5 ... +60					
Temperature of medium		[°C]	-5 ... +50, with holding current reduction -5 ... +60					

- 1) Pneumatic spring
- 2) Mechanical spring
- 3) Minimum pilot pressure 50% of operating pressure

Electrical data	
Electrical connection	Via electrical connection box → Page 103
Operating voltage	[V DC] 5, 12 and 24 ±10%
Power	[W] 1, reduced to 0.35 with holding current reduction
Duty cycle	[%] 100
Degree of protection to EN 60529	IP40 (with plug socket), IP65 (with M8)

Information on materials	
Housing	Wrought aluminium alloy
Seals	HNBR, NBR
Note on materials	RoHS compliant

Dimensions Download CAD data → www.festo.com

2x 3/2-way, 5/2-way and 5/3-way valve

- - Note
More dimensions
Electrical connection boxes
→ Page 105

1 Horizontal electrical connection
 2 Manual override
 3 Connection for external pilot air supply

Type	B1	B2	D1	D2	D3	H1	H2	L1	L2	L3	L4	L5	L6
VUVG-L-14 -...-G18...	14.4	2.3	G1/8	∅ 3.2	M5	34.8	5.8	107	102	8	37	4.85	6.15
VUVG-S-14 -...-G18...													

Type	L7	L8	L9	L10	L11	L12	L13	L14	L15
VUVG-L-14 -...-G18...	66.5	18.35	14.9	18	24.25	13.45	10.8	89.4	86.95
VUVG-S-14 -...-G18...									

Solenoid valves VUVG-L14 and VUVG-S14, in-line valves G1/8

FESTO

Ordering data

★ Core product range

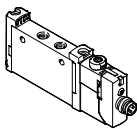
Ordering data				
Description		Part No.	Type	
In-line valve G1/8, with electrical connection box R8				
	2x 3/2-way valve			
	Internal pilot air supply	Normally closed, reset method: pneumatic spring	★ 574226	VUVG-L14-T32C-AT-G18-1R8L
	5/2-way valve, single solenoid			
	Internal pilot air supply	Reset method: pneumatic spring	★ 574229	VUVG-L14-M52-AT-G18-1R8L
	5/2-way valve, double solenoid			
	Internal pilot air supply		★ 574230	VUVG-L14-B52-T-G18-1R8L
	5/3-way valve			
Internal pilot air supply	Mid-position closed	★ 574231	VUVG-L14-P53C-T-G18-1R8L	

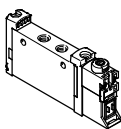
Ordering data				
Description		Part No.	Type	
In-line valve G1/8, without electrical connection box				
	2x 3/2-way valve			
	Internal pilot air supply	Normally closed, reset method: pneumatic spring	566496	VUVG-L14-T32C-AT-G18-1P3
		Normally open, reset method: pneumatic spring	566497	VUVG-L14-T32U-AT-G18-1P3
		1x normally open, 1x normally closed, reset method: pneumatic spring	566498	VUVG-L14-T32H-AT-G18-1P3
		Normally closed, reset method: mechanical spring	574368	VUVG-L14-T32C-MT-G18-1P3
		Normally open, reset method: mechanical spring	574369	VUVG-L14-T32U-MT-G18-1P3
		1x normally open, 1x normally closed, reset method: mechanical spring	574370	VUVG-L14-T32H-MT-G18-1P3
	External pilot air supply	Normally closed, reset method: pneumatic spring	566505	VUVG-L14-T32C-AZT-G18-1P3
		Normally open, reset method: pneumatic spring	566506	VUVG-L14-T32U-AZT-G18-1P3
		1x normally open, 1x normally closed, reset method: pneumatic spring	566507	VUVG-L14-T32H-AZT-G18-1P3
		Normally closed, reset method: mechanical spring	574372	VUVG-L14-T32C-MZT-G18-1P3
		Normally open, reset method: mechanical spring	574373	VUVG-L14-T32U-MZT-G18-1P3
		Normally closed, reset method: mechanical spring	574374	VUVG-L14-T32H-MZT-G18-1P3
	5/2-way valve, single solenoid			
	Internal pilot air supply	Reset method: pneumatic spring	566499	VUVG-L14-M52-AT-G18-1P3
		Reset method: mechanical spring	574371	VUVG-L14-M52-MT-G18-1P3
	External pilot air supply	Reset via pneumatic spring	566508	VUVG-L14-M52-AZT-G18-1P3
		Reset method: mechanical spring	574375	VUVG-L14-M52-MZT-G18-1P3
	5/2-way valve, double solenoid			
	Internal pilot air supply		566500	VUVG-L14-B52-T-G18-1P3
	External pilot air supply		566509	VUVG-L14-B52-ZT-G18-1P3

Festo core product range

★ Ready for dispatch from the Festo factory in 24 hours

☆ Ready for dispatch in 5 days maximum from stock

Solenoid valves VUVG-L14 and VUVG-S14, in-line valves G1/8

Ordering data

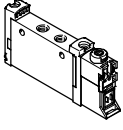
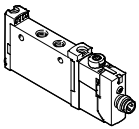
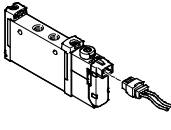
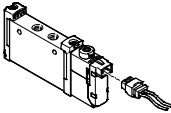
Ordering data					
	Description		Part No.	Type	
In-line valve G1/8, without electrical connection box					
	5/3-way valve				
	Internal pilot air supply	Mid-position closed	566501	VUVG-L14-P53C-T-G18-1P3	
		Mid-position exhausted	566502	VUVG-L14-P53E-T-G18-1P3	
		Mid-position pressurised	566503	VUVG-L14-P53U-T-G18-1P3	
	External pilot air supply	Mid-position closed	566510	VUVG-L14-P53C-ZT-G18-1P3	
		Mid-position exhausted	566511	VUVG-L14-P53E-ZT-G18-1P3	
Mid-position pressurised		566512	VUVG-L14-P53U-ZT-G18-1P3		
In-line valve G1/8, with electrical connection box R8					
	2x 3/2-way valve				
	Internal pilot air supply	Normally open, reset method: pneumatic spring	574227	VUVG-L14-T32U-AT-G18-1R8L	
		1x normally open, 1x normally closed, reset method: pneumatic spring	574228	VUVG-L14-T32H-AT-G18-1R8L	
		Normally closed, reset method: mechanical spring	8031504	VUVG-L14-T32C-MT-G18-1R8L	
		Normally open, reset method: mechanical spring	8031505	VUVG-L14-T32U-MT-G18-1R8L	
		1x normally open, 1x normally closed, reset method: mechanical spring	8031506	VUVG-L14-T32H-MT-G18-1R8L	
	5/2-way valve, single solenoid				
	Internal pilot air supply	Reset method: mechanical spring	8031508	VUVG-L14-M52-MT-G18-1R8L	
	5/3-way valve				
	Internal pilot air supply	Mid-position exhausted	574233	VUVG-L14-P53E-T-G18-1R8L	
Mid-position pressurised		574232	VUVG-L14-P53U-T-G18-1R8L		
In-line valve G1/8, with electrical connection box H2					
	2x 3/2-way valve				
	Internal pilot air supply	Normally closed, reset method: pneumatic spring	577321	VUVG-L14-T32C-AT-G18-1H2L-W1	
	5/2-way valve, single solenoid				
	Internal pilot air supply	Reset method: pneumatic spring	576256	VUVG-L14-M52-AT-G18-1H2L-W1	
		Reset method: mechanical spring	578164	VUVG-L14-M52-MT-G18-1H2L-W1	
	5/2-way valve, double solenoid				
Internal pilot air supply		577319	VUVG-L14-B52-T-G18-1H2L-W1		
Semi in-line valve G1/8, with electrical connection box H2					
5/2-way valve, single solenoid					
	Internal pilot air supply	Reset method: pneumatic spring	577325	VUVG-S14-M52-AT-G18-1H2L-W1	

Solenoid valves VUVG-S14, in-line valves G1/8

Manifold assembly



In-line valves for manifold assembly

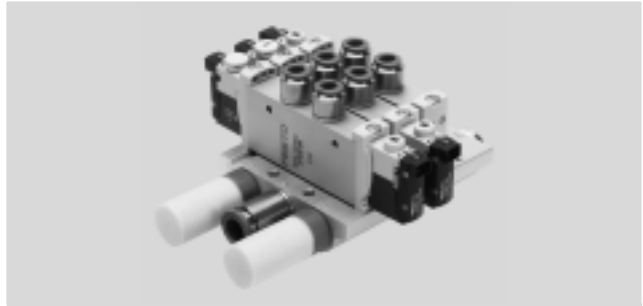

Dimensions

Download CAD data → www.festo.com

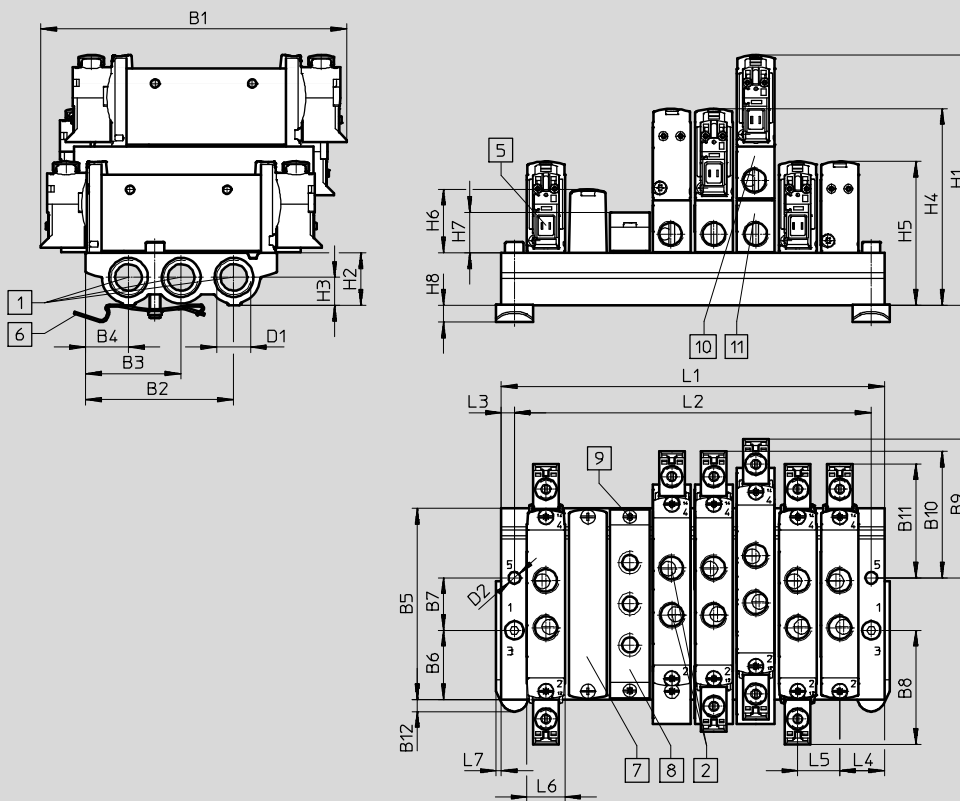

Note
 More dimensions
 Electrical connection boxes
 → Page 105

- 1 Ports 1, 3 and 5
- 2 Ports 2 and 4
- 5 Electrical connection for electrical connection boxes and accessories
- 6 H-rail mounting (two M4x25 screws are required for mounting)
- 7 Blanking plate
- 8 Supply plate
- 9 Valves/blanking plate mounting on manifold rail
- 10 Vertical pressure supply plate
- 11 Vertical pressure exhaust plate

Type	B1	B2	B3	B4	B5	B6	B7	B8	B9	B10	B11	B12	D1	D2
VABM-L1-14S-G14	116.6	56.6	36.5	16.4	72.9	26.5	20	43.5	53.1	48.3	43.5	4.5	G1/4	4.5

Type	H1	H2	H3	H4	H5	H6	H7	H8	L3	L4	L5	L6	L7
VABM-L1-14S-G14	95.3	20	10.6	74.9	54.8	23.9	15.4	6.5	5	17	16	14.5	2

Valve positions	2	3	4	5	6	7	8	9	10	12	14	16	22
L1	50	66	82	98	114	130	146	162	178	210	242	274	306
L2	40	56	72	88	104	120	136	152	168	200	232	264	296
VABM weight [g]	118	159	200	241	282	323	364	405	446	528	610	692	938

Solenoid valves VUVG-S14, in-line valves G1/8

Ordering data

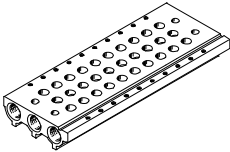
Technical data – Manifold rails							
	Port	CRC	Material ²⁾	Operating pressure [bar]	Max. tightening torque for assembly [Nm]		
	1, 3, 5				Valve	H-rail	Wall
	G1/4	2 ¹⁾	Wrought aluminium alloy	-0.9 ... 10	0.65	1.5	3

- 1) Corrosion resistance class CRC 2 to Festo standard FN 940070
Moderate corrosion stress. Indoor applications in which condensation may occur. External visible parts with primarily decorative requirements for the surface and which are in direct contact with the ambient atmosphere typical for industrial applications.
- 2) Note on materials: RoHS-compliant.

Order code – Manifold rails

VABM	-	L1	-	14	S	-	G14	-	
Manifold assembly parts									Number of valve positions
Manifold rail		VABM							2 to 10, 12, 14 and 16
Valve series									Ports 1, 3, 5
VUVG		L1					G14		G1/4 thread
Valve size									
14 mm				14					
Manifold rail with ports 1, 3, 5									
For G1/8 in-line valves					S				

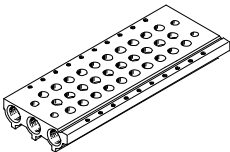
Ordering data – Manifold rail			
	Description	Part No.	Type
Manifold rail for in-line valves (manifold assembly)			
	For size G1/8	2 valve positions	★ 566618 VABM-L1-14S-G14-2
		3 valve positions	★ 566619 VABM-L1-14S-G14-3
		4 valve positions	★ 566620 VABM-L1-14S-G14-4
		5 valve positions	566621 VABM-L1-14S-G14-5
		6 valve positions	★ 566622 VABM-L1-14S-G14-6
		7 valve positions	566623 VABM-L1-14S-G14-7
		8 valve positions	★ 566624 VABM-L1-14S-G14-8
		9 valve positions	566625 VABM-L1-14S-G14-9
		10 valve positions	★ 566626 VABM-L1-14S-G14-10
		12 valve positions	566627 VABM-L1-14S-G14-12
		14 valve positions	566628 VABM-L1-14S-G14-14
16 valve positions	566629 VABM-L1-14S-G14-16		







Festo core product range

- ★ Ready for dispatch from the Festo factory in 24 hours
- ☆ Ready for dispatch in 5 days maximum from stock

Solenoid valves VUVG-S14, in-line valves G1/8

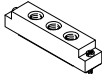
FESTO

Ordering data

Ordering data – Accessories			
	Description	Part No.	Type
Blanking plate Technical data → Internet: vabb			
	For valve position on manifold rail, including screws and seal	★ 569989	VABB-L1-14
Separator Technical data → Internet: vabd			
	For creating pressure zones	569996	VABD-10-B
Supply plate Technical data → Internet: vabf			
	For valve position on manifold rail, including screws and seal	569993	VABF-L1-14-P3A4-G18
Seals for in-line valves Technical data → Internet: vabd			
	In-line valves VUVG-LK		
	For G1/8 in-line valves	Delivery unit: 10 sets (each with 2 screws and 1 seal)	★ 8043720 VABD-L1-14XK-S-G18-S
	In-line valves VUVG-L		
	For G1/8 in-line valves	Delivery unit: 10 sets (each with 2 screws and 1 seal)	★ 566675 VABD-L1-14X-S-G18
Vertical pressure supply plate			
	Pneumatic connection 1: G1/8	Terminal code CP	574593 VABF-L1-P3A3-G18
Vertical exhaust plate			
	Pneumatic connection 3, 5: G1/8	Terminal code CR	574595 VABF-L1-P7A13-G18

Festo core product range

- ★ Ready for dispatch from the Festo factory in 24 hours
- ☆ Ready for dispatch in 5 days maximum from stock

Solenoid valves VUVG, in-line valves G1/4

Order code

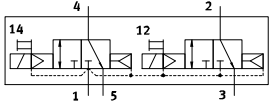
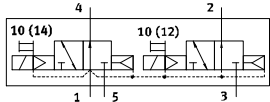
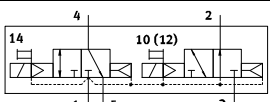
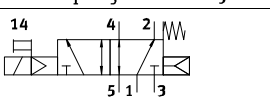
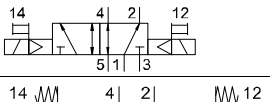
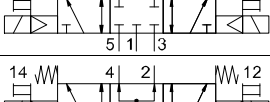
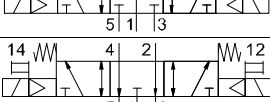
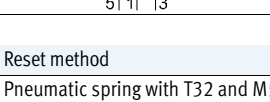
VUVG	-	18	-	-	-	-
Type of directional control valve						
In-line, individual valve	L					
Semi in-line, manifold valve incl. seal and screws	S					
Design principle						
Piston spool with sealing cartridge	-					
Valve size						
18 mm		18				
Valve functions						
						T32C
						T32U
						T32H
						M52
						B52
						P53C
						P53U
						P53E
Reset method						
Pneumatic spring with T32 and M52						A
Mechanical spring with T32 and M52						M
Pneu./mech. spring with M52						R
With B52 and P53						-
Pilot air supply						
Internal						-
External						Z
Manual override						
Non-detenting						H
Covered						S
Non-detenting, detenting						T
Detenting, without accessories						Y

						L	-
Connecting cables							
W1...4							Not sheathed
C1...4							Sheathed
WS1...4							Not sheathed
S1...4							Sheathed
N1...4							M8x1, 3-pin
N5...8							M8x1, 4-pin
Display							
L							LED
Protective circuit							
-							Without holding current reduction (HCR)
R							With holding current reduction (HCR)
Electrical connection box							
H2							Connection pattern H, horizontal plug connector
H3							Connection pattern H, vertical plug connector
S2							Connection pattern S, horizontal plug connector
S3							Connection pattern S, vertical plug connector
L1...4							With 2x flying leads L: 1 = 0.5 m, 2 = 1 m, 3 = 2.5 m, 4 = 5 m
K6...9							Cable: K6 = 0.5 m, K7 = 1 m, K8 = 2.5 m, K9 = 5 m
R1							Individual plug connector M8, 4-pin
R8							Individual plug connector M8, 3-pin
P3							Without electrical connection box
Operating voltage							
1							24 V DC
5							12 V DC
4							5 V DC
Exhausting with VUVG-L							
QN							Push-in fitting
U							Silencer
-							G1/4 thread
Pneumatic connection							
G14							G1/4 thread
Q6							Push-in connector 6 mm
Q8							Push-in connector 8 mm
Q10							Push-in connector 10 mm
T14							Push-in connector 1/4"
T38							Push-in connector 3/8"
T516							Push-in connector 5/16"

Solenoid valves VUVG-L18 and VUVG-S18, in-line valves G1/4



FESTO

Technical data

Function

2x 3/2C, 2x 3/2U, 2x 3/2H
5/2-way, single solenoid
5/2-way, double solenoid
5/3C, 5/3U, 5/3E

Circuit symbol → Page 13

-  - Valve size 18 mm
-  - Flow rate
1000 ... 1380 l/min
-  - Voltage
5, 12 and 24 V DC



General technical data, VUVG-L G1/4										
Valve function	T32-A			T32-M			M52-R	B52	M52-M	P53
Normal position	C ¹⁾	U ²⁾	H ⁴⁾	C ¹⁾	U ²⁾	C ¹⁾	-	-	-	C ¹⁾ U ²⁾ E ³⁾
Stable position	Monostable							Bistable	Monostable	
Reset method: pneumatic spring	Yes			No			Yes ⁵⁾	-	No	-
Reset method: mechanical spring	No			Yes			Yes ⁵⁾	-	Yes	-
Vacuum operation at port 1	No			Only with external pilot air supply						
Design	Piston spool									
Sealing principle	Soft									
Actuation type	Electrical									
Type of control	Pilot									
Pilot air supply	Internal/external									
Exhaust function	With flow control									
Manual override	Choice of non-detenting, covered, non-detenting/detenting or detenting									
Type of mounting	Optionally via through-holes ⁶⁾ or on manifold rail									
Mounting position	Any									
Nominal width [mm]	5.7			6.9			7.3	6.9	6.5	6.3
Standard nominal flow rate [l/min]	1000			1300			1380	1300	1200	1000
Flow rate on manifold rail	1000			1300			1380	1300	1200	1000
Switching time on/off [ms]	13/27			15/22			15/31		10/45	15/48
Changeover time [ms]	-			-			11	-	29	
Valve size [mm]	18									
Port	1, 2, 3, 4, 5 12/14			G1/4 M5						
Product weight [g]	164			154			164	154	160	
Certification	c UL us - Recognized (OL) c CSA us (OL) RCM									
CE marking (see declaration of conformity) ⁷⁾	In accordance with EU EMC Directive									
Corrosion resistance class CRC ⁸⁾	2									

1) C=Normally closed/mid-position closed

2) U=Normally open/mid-position pressurised

3) E=Mid-position exhausted

4) H=2x 3/2-way valve in one housing with 1x normally closed and 1x normally open

5) Combined reset method

6) If several valves are to be screwed together via the through-holes to form a block, a minimum distance of 0.3 mm must be ensured by placing spacer discs between them.

7) For information about the applicability of the component see the manufacturer's EC declaration of conformity at: www.festo.com/sp → Certificates.

If the component is subject to restrictions on usage in residential, office or commercial environments or small businesses, further measures to reduce the emitted interference may be necessary.

8) Corrosion resistance class CRC 2 to Festo standard FN 940070

Moderate corrosion stress. Indoor applications in which condensation may occur. External visible parts with primarily decorative requirements for the surface and which are in direct contact with the ambient atmosphere typical for industrial applications.

Solenoid valves VUVG-L18 and VUVG-S18, in-line valves G1/4

Technical data

Operating and environmental conditions						
Valve function			T32-A ¹⁾	T32-M ³⁾	M52-R ²⁾	B52, M52-M ³⁾ , P53
Operating medium	Compressed air in accordance with ISO 8573-2010 [7:4:4]					
Operating pressure	Internal	[bar]	1.5 ... 8	3 ... 8	2.5 ... 8	1.5 ... 8, 3 ... 8
	External	[bar]	1.5 ... 10	-0.9 ... 10		
Pilot pressure ⁴⁾		[bar]	1.5 ... 8	2 ... 8	2.5 ... 8	1.5 ... 8, 3 ... 8
Ambient temperature		[°C]	-5 ... +50, with holding current reduction -5 ... +60			
Temperature of medium		[°C]	-5 ... +50, with holding current reduction -5 ... +60			

- 1) Pneumatic spring
- 2) Mixed, pneumatic/mechanical spring
- 3) Mechanical spring
- 4) Minimum pilot pressure 50% of operating pressure

Electrical data	
Electrical connection	Via electrical connection box → Page 103
Operating voltage	[V DC] 5, 12 and 24 ±10%
Power	[W] 1, reduced to 0.35 with holding current reduction
Duty cycle	[%] 100
Degree of protection to EN 60529	IP40 (with plug socket), IP65 (with M8)

Information on materials	
Housing	Wrought aluminium alloy
Seals	HNBR, NBR
Note on materials	RoHS compliant

Dimensions Download CAD data → www.festo.com

2x 3/2-way, 5/2-way and 5/3-way valve

- Note
More dimensions
Electrical connection boxes
→ Page 105

1 Electrical connection without electrical connection box
 2 Mounting screw
 3 Connection for external pilot air supply

Type	B1	B2	D1	D2	D3	H1	H2	H3	L1	L2	L3	L4	L5
VUVG-L-18...	18.3	4.5	G1/4	∅ 4.2	M5	43.1	37.8	6.4	129.4	124.4	86.4	112.2	109.7
VUVG-S-18...													

Type	L6	L7	L8	L9	L10	L11	L12	L13
VUVG-L-18...	86	52	19.7	31.3	23.8	21.7	21.1	14
VUVG-S-18...								

Solenoid valves VUVG-L18 and VUVG-S18, in-line valves G1/4

FESTO

Ordering data

★ Core product range

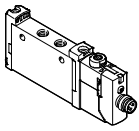
Ordering data				
Description	Part No.	Type		
In-line valve G1/4, with electrical connection box R8				
	2x 3/2-way valve			
	Internal pilot air supply	Normally closed, reset method: pneumatic spring	★ 8031525	VUVG-L18-T32C-AT-G14-1R8L
	5/2-way valve, single solenoid			
	Internal pilot air supply	Reset method: pneumatic/mechanical spring	★ 8031531	VUVG-L18-M52-RT-G14-1R8L
		Reset method: mechanical spring	★ 8031532	VUVG-L18-M52-MT-G14-1R8L
	5/3-way valve			
Internal pilot air supply	Mid-position closed	★ 8031534	VUVG-L18-P53C-T-G14-1R8L	

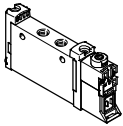
Ordering data				
Description	Part No.	Type		
In-line valve G1/4, without electrical connection box				
	2x 3/2-way valve			
	Internal pilot air supply	Normally closed, reset method: pneumatic spring	574422	VUVG-L18-T32C-AT-G14-1P3
		Normally open, reset method: pneumatic spring	574423	VUVG-L18-T32U-AT-G14-1P3
		1x normally open, 1x normally closed, reset method: pneumatic spring	574424	VUVG-L18-T32H-AT-G14-1P3
		Normally closed, reset method: mechanical spring	574425	VUVG-L18-T32C-MT-G14-1P3
		Normally open, reset method: mechanical spring	574426	VUVG-L18-T32U-MT-G14-1P3
		1x normally open, 1x normally closed, reset method: mechanical spring	574427	VUVG-L18-T32H-MT-G14-1P3
	External pilot air supply	Normally closed, reset method: mechanical spring	574434	VUVG-L18-T32C-MZT-G14-1P3
		Normally open, reset method: mechanical spring	574435	VUVG-L18-T32U-MZT-G14-1P3
		1x normally open, 1x normally closed, reset method: mechanical spring	574436	VUVG-L18-T32H-MZT-G14-1P3
	5/2-way valve, single solenoid			
	Internal pilot air supply	Reset method: pneumatic/mechanical spring	574428	VUVG-L18-M52-RT-G14-1P3
		Reset via mechanical spring	574429	VUVG-L18-M52-MT-G14-1P3
	External pilot air supply	External pilot air supply, reset method: mechanical spring	574438	VUVG-L18-M52-MZT-G14-1P3
		External pilot air supply, pneumatic/mechanical spring return	574437	VUVG-L18-M52-RZT-G14-1P3
	5/2-way valve, double solenoid			
	Internal pilot air supply		574430	VUVG-L18-B52-T-G14-1P3
	External pilot air supply		574439	VUVG-L18-B52-ZT-G14-1P3

Festo core product range

- ★ Ready for dispatch from the Festo factory in 24 hours
- ☆ Ready for dispatch in 5 days maximum from stock

Solenoid valves VUVG-L18 and VUVG-S18, in-line valves G1/4

Ordering data

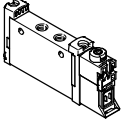
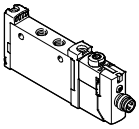
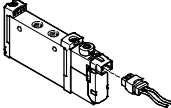
Ordering data					
	Description		Part No.	Type	
In-line valve G1/4, without electrical connection box					
	5/3-way valve				
	Internal pilot air supply	Mid-position closed	574431	VUVG-L18-P53C-T-G14-1P3	
		Mid-position exhausted	574432	VUVG-L18-P53E-T-G14-1P3	
		Mid-position pressurised	574433	VUVG-L18-P53U-T-G14-1P3	
	External pilot air supply	Mid-position closed	574440	VUVG-L18-P53C-ZT-G14-1P3	
		Mid-position exhausted	574441	VUVG-L18-P53E-ZT-G14-1P3	
Mid-position pressurised		574442	VUVG-L18-P53U-ZT-G14-1P3		
In-line valve G1/4, with electrical connection box R8					
	2x 3/2-way valve				
	Internal pilot air supply	Normally open, reset method: pneumatic spring	8031526	VUVG-L18-T32U-AT-G14-1R8L	
		1x normally open, 1x normally closed, reset method: pneumatic spring	8031527	VUVG-L18-T32H-AT-G14-1R8L	
		Normally closed, reset method: mechanical spring	8031528	VUVG-L18-T32C-MT-G14-1R8L	
		Normally open, reset method: mechanical spring	8031529	VUVG-L18-T32U-MT-G14-1R8L	
		1x normally open, 1x normally closed, reset method: mechanical spring	8031530	VUVG-L18-T32H-MT-G14-1R8L	
	5/2-way valve, double solenoid				
	Internal pilot air supply		8031533	VUVG-L18-B52-T-G14-1R8L	
	5/3-way valve				
	Internal pilot air supply	Mid-position exhausted	8031535	VUVG-L18-P53E-T-G14-1R8L	
		Mid-position pressurised	8031536	VUVG-L18-P53U-T-G14-1R8L	
In-line valve G1/4, with electrical connection box H2					
5/2-way valve, single solenoid					
	Internal pilot air supply	Reset method: pneumatic spring	578823	VUVG-L18-M52-RT-G14-1H2L-W1	

Solenoid valves VUVG-S18, in-line valves G1/4

Manifold assembly



In-line valves for manifold assembly

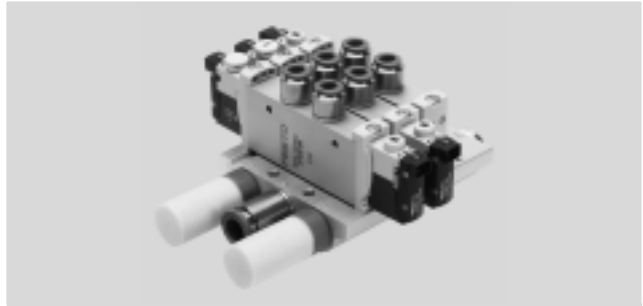

Dimensions

Download CAD data → www.festo.com

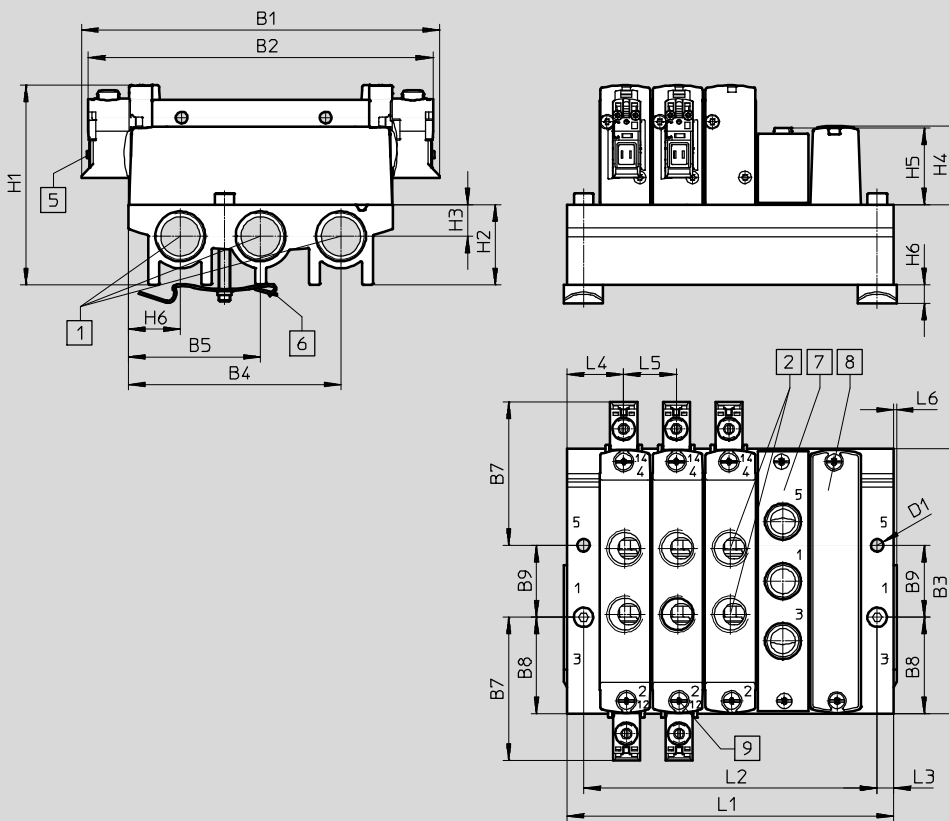

Note
 More dimensions
 Electrical connection boxes
 → Page 105

- [1] Ports 1, 3 and 5
- [2] Ports 2 and 4
- [5] Electrical connection for electrical connection boxes and accessories
- [6] H-rail mounting (two M4x35 screws are required for mounting)
- [7] Blanking plate
- [8] Supply plate
- [9] Valves/blanking plate mounting on manifold rail

Type	B1	B2	B3	B4	B5	B6	B7	B8	B9	D1
VABM-L1-18S-G38	129.4	124.4	95.6	76.8	47.8	18.8	51.7	34.8	26	4.5

Type	H1	H2	H3	H4	H5	H6	L3	L4	L5	L6
VABM-L1-18S-G38	72.1	29	11.5	28.4	27.6	6.5	6	20.5	19	1

Valve positions	2	3	4	5	6	7	8	9	10	12	14	16
L1	61	80	99	118	137	156	175	194	213	251	289	327
L2	49	68	87	106	125	144	163	182	201	239	277	315
VABM weight [g]	118	159	200	241	282	323	364	405	446	528	610	692

Solenoid valves VUVG-S18, in-line valves G1/4

Ordering data

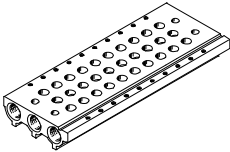
Technical data – Manifold rails							
	Port	CRC	Material ²⁾	Operating pressure [bar]	Max. tightening torque for assembly [Nm]		
	1, 3, 5				Valve	H-rail	Wall
	G3/8	2 ¹⁾	Wrought aluminium alloy	-0.9 ... 10	1.18	1.5	3

- 1) Corrosion resistance class CRC 2 to Festo standard FN 940070
Moderate corrosion stress. Indoor applications in which condensation may occur. External visible parts with primarily decorative requirements for the surface and which are in direct contact with the ambient atmosphere typical for industrial applications.
- 2) Note on materials: RoHS-compliant.

Order code – Manifold rails

VABM	-	L1	-	18	S	-	G38	-	
Manifold assembly parts									Number of valve positions
Manifold rail		VABM							2 to 10, 12, 14 and 16
Valve series									Ports 1, 3, 5
VUVG		L1					G38		G3/8 thread
Valve size									
18 mm				18					
Manifold rail with ports 1, 3, 5									
For G1/4 in-line valves					S				

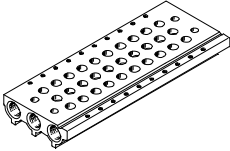
Ordering data – Manifold rail			
	Description	Part No.	Type
	For size G1/4	2 valve positions	★ 574455 VABM-L1-18S-G38-2
		3 valve positions	★ 574456 VABM-L1-18S-G38-3
		4 valve positions	★ 574457 VABM-L1-18S-G38-4
		5 valve positions	574458 VABM-L1-18S-G38-5
		6 valve positions	★ 574459 VABM-L1-18S-G38-6
		7 valve positions	574460 VABM-L1-18S-G38-7
		8 valve positions	★ 574461 VABM-L1-18S-G38-8
		9 valve positions	574462 VABM-L1-18S-G38-9
		10 valve positions	★ 574463 VABM-L1-18S-G38-10
		12 valve positions	574464 VABM-L1-18S-G38-12
		14 valve positions	574465 VABM-L1-18S-G38-14
		16 valve positions	574466 VABM-L1-18S-G38-16





Festo core product range

- ★ Ready for dispatch from the Festo factory in 24 hours
- ☆ Ready for dispatch in 5 days maximum from stock

Solenoid valves VUVG-S18, in-line valves G1/4

FESTO

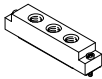
Ordering data

Ordering data – Accessories			
	Description	Part No.	Type
Blanking plate Technical data → Internet: vabb			
	For valve position on manifold rail, including screws and seal	★ 574482	VABB-L1-18
Separator Technical data → Internet: vabd			
	For creating pressure zones	574483	VABD-14-B
Supply plate Technical data → Internet: vabf			
	For valve position on manifold rail, including screws and seal	574481	VABF-L1-18-P3A4-G14
Seals for in-line valves Technical data → Internet: vabd			
	For G1/4 in-line valves	Delivery unit: 10 sets (each with 2 screws and 1 seal)	★ 574479 VABD-L1-18X-S-G14



Note

Connect supply plate at port 1 with compressed air. Reverse operation (pressure at port 3, 5) is not permissible.

Festo core product range

- ★ Ready for dispatch from the Festo factory in 24 hours
- ☆ Ready for dispatch in 5 days maximum from stock

Solenoid valves VUVG, sub-base valves M3

Order code

VUVG	-	B	10A	-	-	-	Z
Type of directional control valve							
Sub-base, manifold valve incl. seal and screws							B
Design principle							
Piston spool with sealing cartridge							-
Valve size							
10 mm							10A
Valve functions							
							M52
							B52
							P53C
							P53U
							P53E
Reset method							
Mech. spring with M52							M
Pneu./mech. spring with M52							R
With B52 and P53							-
Pilot air supply							
External							Z
Manual override							
Non-detenting							H
Covered							S
Non-detenting, detenting							T
Detenting, without accessories							Y

F	-	-	-	L	-
Connecting cables					
W1...4		Not sheathed			
C1...4		Sheathed			
WS1...4		Not sheathed			
S1...4		Sheathed			
N1...4		M8x1, 3-pin			
N5...8		M8x1, 4-pin			
Display					
L		LED			
Protective circuit					
-		Without holding current reduction (HCR)			
R		With holding current reduction (HCR)			
Electrical connection box					
H2		Connection pattern H, horizontal plug connector			
H3		Connection pattern H, vertical plug connector			
S2		Connection pattern S, horizontal plug connector			
S3		Connection pattern S, vertical plug connector			
L1...4		With 2x flying leads L: 1 = 0.5 m, 2 = 1 m, 3 = 2.5 m, 4 = 5 m			
K6...9		Cable: K6 = 0.5 m, K7 = 1 m, K8 = 2.5 m, K9 = 5 m			
R1		Individual plug connector M8, 4-pin			
R8		Individual plug connector M8, 3-pin			
P3		Without electrical connection box			
Operating voltage					
1		24 V DC			
5		12 V DC			
4		5 V DC			
Pneumatic connection					
F		In the manifold rail			



Solenoid valves VUVG-B10A, sub-base valves M3

Technical data

Function

- 5/2-way, single solenoid
- 5/2-way valve, double solenoid
- 5/3C, 5/3U, 5/3E

Circuit symbol → Page 13

-  - Valve size 10 mm
-  - Flow rate
90 ... 100 l/min
-  - Voltage
5, 12 and 24 V DC



General technical data, VUVG-B M3						
Valve function	M52-R	B52	M52-M	P53		
Normal position	–	–	–	C ¹⁾	U ²⁾	E ³⁾
Stable position	Monostable	Bistable	Monostable	Monostable		
Reset method: pneumatic spring	Yes ⁴⁾	–	No	No		
Reset method: mechanical spring	Yes ⁴⁾	–	Yes	Yes		
Vacuum operation at port 1	Only with external pilot air supply					
Design	Piston spool					
Sealing principle	Soft					
Actuation type	Electrical					
Type of control	Pilot					
Pilot air supply	External, internal; can be selected via sub-base					
Exhaust function	With flow control					
Manual override	Choice of non-detenting, covered, non-detenting/detenting or detenting					
Type of mounting	On manifold rail					
Mounting position	Any					
Nominal width	[mm]	2	1.4	2		
Standard nominal flow rate	[l/min]	100	80	90		
Flow rate on manifold rail M3	[l/min]	100	80	90		
Switching time on/off	[ms]	7/15	–	7/21	8/25	
Changeover time	[ms]	–	5	–	14	
Valve size	[mm]	10				
Port	1, 3, 5	M7 in manifold rail				
	2, 4	M5 in manifold rail				
	12/14, 82/84	M5 in manifold rail				
Product weight	[g]	38	49	37	49	
Certification	c UL us - Recognized (OL)					
	c CSA us (OL)					
	RCM					
CE marking (see declaration of conformity) ⁵⁾	In accordance with EU EMC Directive					
Corrosion resistance class CRC ⁶⁾	2					

1) C=Normally closed/mid-position closed
 2) U=Normally open/mid-position pressurised
 3) E=Mid-position exhausted
 4) Combined reset method
 5) For information about the applicability of the component see the manufacturer's EC declaration of conformity at: www.festo.com/sp → Certificates.
 If the component is subject to restrictions on usage in residential, office or commercial environments or small businesses, further measures to reduce the emitted interference may be necessary.
 6) Corrosion resistance class CRC 2 to Festo standard FN 940070
 Moderate corrosion stress. Indoor applications in which condensation may occur. External visible parts with primarily decorative requirements for the surface and which are in direct contact with the ambient atmosphere typical for industrial applications.

Solenoid valves VUVG-B10A, sub-base valves M3

Technical data

Operating and environmental conditions					
Valve function		M52-R ¹⁾	B52	M52-M ²⁾	P53
Operating medium		Compressed air in accordance with ISO 8573-2010 [7:4:4]			
Operating pressure	Internal	[bar]	2.5 ... 8	1.5 ... 8	3 ... 8
	External	[bar]	-0.9 ... 10		-0.9 ... 10
Pilot pressure ³⁾		[bar]	2.5 ... 8	1.5 ... 8	2 ... 8
Ambient temperature		[°C]	-5 ... +50, with holding current reduction -5 ... +60		
Temperature of medium		[°C]	-5 ... +50, with holding current reduction -5 ... +60		

- 1) Mixed, pneumatic/mechanical spring
- 2) Mechanical spring
- 3) Minimum pilot pressure 50% of operating pressure

Electrical data	
Electrical connection	Via electrical connection box → Page 103
Operating voltage	[V DC] 5, 12 and 24 ±10%
Power	[W] 1, reduced to 0.35 with holding current reduction
Duty cycle	[%] 100
Degree of protection to EN 60529	IP40 (with plug socket), IP65 (with M8)

Information on materials	
Housing	Wrought aluminium alloy
Seals	HNBR, NBR
Note on materials	RoHS compliant

Dimensions Download CAD data → www.festo.com

5/2-way and 5/3-way valve

- - Note
More dimensions
Electrical connection boxes
→ Page 105

1 Vertical electrical connection 2 Manual override

Type	B1	H1	L1	L2	L3	L4	L5	L6	L7
VUVG-B10A-...-F...	10.2	32.5	73.9	68.9	8	4.85	6.15	56.9	54.4

Solenoid valves VUVG-B10A, sub-base valves M3

Ordering data

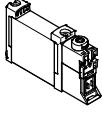
Ordering data				
Description		Part No.	Type	
Sub-base valve M3, without electrical connection box				
	5/2-way valve, single solenoid			
	External pilot air supply	Reset method: pneumatic/mechanical spring	566448	VUVG-B10A-M52-RZT-F-1P3
		Reset method: mechanical spring	574347	VUVG-B10A-M52-MZT-F-1P3
	5/2-way valve, double solenoid			
	External pilot air supply		566449	VUVG-B10A-B52-ZT-F-1P3
	5/3-way valve			
	External pilot air supply	Mid-position closed	566450	VUVG-B10A-P53C-ZT-F-1P3
		Mid-position exhausted	566451	VUVG-B10A-P53E-ZT-F-1P3
		Mid-position pressurised	566452	VUVG-B10A-P53U-ZT-F-1P3

Solenoid valves VUVG-B10A, sub-base valves M3

Manifold assembly

Sub-base valve for manifold assembly
Connection M5



Dimensions

Download CAD data → www.festo.com

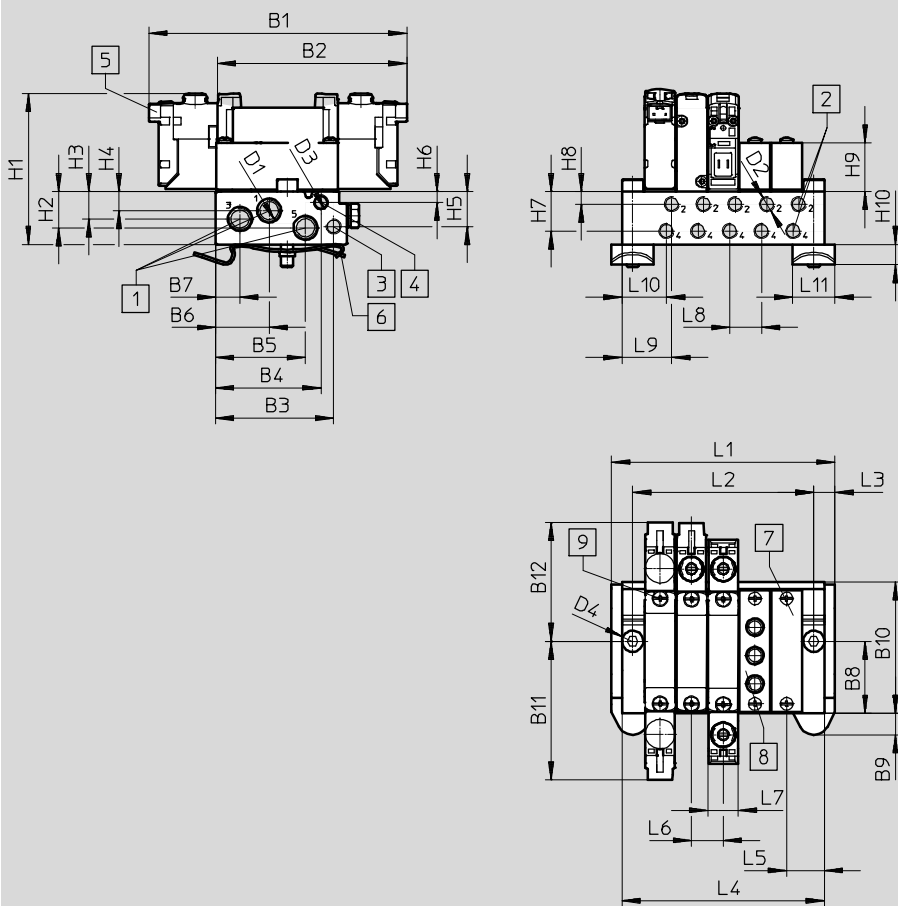

Note
More dimensions
Electrical connection boxes
→ Page 105

- 1 Ports 1, 3 and 5
- 2 Ports 2 and 4
- 3 Ports 12, 14
- 4 Ports 82, 84
- 5 Electrical connection for electrical connection boxes and accessories
- 6 H-rail mounting (two M4x25 screws are required for mounting)
- 7 Blanking plate
- 8 Supply plate
- 9 Valves/blanking plate mounting on manifold rail

Type	B1	B2	B3	B4	B5	B6	B7	B8	B9	B10	B11	B12
VABM-L1-10AW-M7	84.9	62.4	39.1	35	29.8	17.8	8.2	24	7.2	43.5	45.8	39.2

Type	D1	D2	D3	D4	D5	H1	H2	H3	H4	H5	H6
VABM-L1-10AW-M7	M7	M5	M5	∅ 4.5	∅ 4	53.1	12	9.1	6.3	11.6	3.6

Type	H7	H8	H9	H10	H15	L3	L5	L6	L7	L8	L9	L10	L11
VABM-L1-10AW-M7	13.1	4.2	16.2	6.8	1.9	7.5	12.5	10.5	10.2	10.5	17	15.2	14

Solenoid valves VUVG-B10A, sub-base valves M3

Ordering data

Valve positions	2	3	4	5	6	7	8	9	10	12	14	16
L1	43.5	54	64.5	75	85.5	97	107.5	117	127.5	148.5	169.5	190.5
L2	28.5	39	49.5	60	70.5	81	91.5	102	112.5	133.5	154.5	175.5
L4	36.5	47	57.5	68	78.5	89	99.5	110	120.5	141.5	162.5	183.5
VABM weight [g]	60	78	96	114	132	150	168	186	204	240	276	312

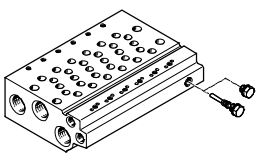
Technical data – Manifold rails ¹⁾									
	Port			CRC	Material ³⁾	Operating pressure [bar]	Max. tightening torque for assembly [Nm]		
	2, 4	1, 3, 5	12/14, 82/84				Valve	H-rail	Wall
	M5	M7	M5	2 ²⁾	Wrought aluminium alloy	-0.9 ... 10	0.45	1.5	1.5

- 1) Blanking plugs are included with the manifold rail.
- 2) Corrosion resistance class CRC 2 to Festo standard FN 940070
Moderate corrosion stress. Indoor applications in which condensation may occur. External visible parts with primarily decorative requirements for the surface and which are in direct contact with the ambient atmosphere typical for industrial applications.
- 3) Note on materials: RoHS-compliant.

Order code – Manifold rails



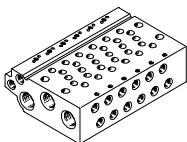

VABM	-	L1	-	10A	W	-	M7	-	
Manifold assembly parts									
Manifold rail	VABM			Number of valve positions 2 to 10, 12, 14 and 16					
Valve series	Port 1, 3, 5								
VUVG	L1			M7 M7 thread					
Valve size	10 mm 10A								
Manifold rail with port 1, 2, 3, 4, 5, 12/14, 82/84									
Port 2 and 4 with M5 thread									W

Ordering data – Manifold rails

Description	Part No.	Type	
Manifold rail for sub-base valve M3			
	For size B10A (M3)		
	2 valve positions	566546	VABM-L1-10AW-M7-2
	3 valve positions	566547	VABM-L1-10AW-M7-3
	4 valve positions	566548	VABM-L1-10AW-M7-4
	5 valve positions	566549	VABM-L1-10AW-M7-5
	6 valve positions	566550	VABM-L1-10AW-M7-6
	7 valve positions	566551	VABM-L1-10AW-M7-7
	8 valve positions	566552	VABM-L1-10AW-M7-8
	9 valve positions	566553	VABM-L1-10AW-M7-9
	10 valve positions	566554	VABM-L1-10AW-M7-10
	12 valve positions	566555	VABM-L1-10AW-M7-12
	14 valve positions	566556	VABM-L1-10AW-M7-14
16 valve positions	566557	VABM-L1-10AW-M7-16	



Solenoid valves VUVG-B10A, sub-base valves M3

Ordering data

Ordering data – Accessories			
	Description	Part No.	Type
Blanking plate Technical data → Internet: vabb			
	For valve position on manifold rail, including screws and seal	569986	VABB-L1-10A
Separator Technical data → Internet: vabd			
	For creating pressure zones	570872	VABD-4.2-B
Supply plate Technical data → Internet: vabf			
	For valve position on manifold rail, including screws and seal	569990	VABF-L1-10A-P3A4-M5
Seals Technical data → Internet: vabd			
	For sub-base valve M3	Delivery unit: 10 sets (each with 2 screws and 1 seal)	566671 VABD-L1-10AB-S-M3

Solenoid valves VUVG, sub base valves M5/M7

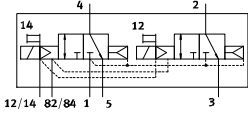
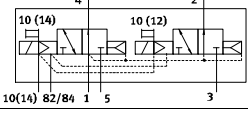
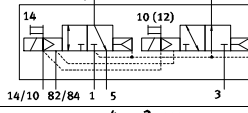
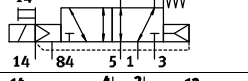
Order code

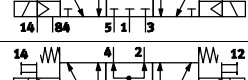
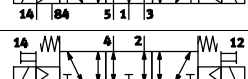
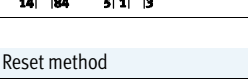

VUVG	-	B	10	-	-	-	Z	
Type of directional control valve								
Sub-base, manifold valve incl. seal and screws		B						
Design principle								
Piston spool with sealing cartridge		-						
Piston spool with sealing ring		K						
Valve size								
10 mm		10						
Valve functions								
		T32C						
		T32U						
		T32H						
		M52						
		B52						
		P53C						
		P53U						
		P53E						
Reset method								
Pneumatic spring with T32 and M52		A						
Mechanical spring with T32 and M52		M						
Pneu./mech. spring with M52		R						
With B52 and P53		-						
Pilot air supply								
External		Z						
Manual override								
Non-detenting		H						
Covered		S						
Non-detenting, detenting		T						
Detenting, without accessories		Y						

F	-	-	-	L	-	-	-
Version							
- Extended features							
S Core features							
Connecting cables							
W1...4 Not sheathed							
C1...4 Sheathed							
WS1...4 Not sheathed							
S1...4 Sheathed							
N1...4 M8x1, 3-pin							
N5...8 M8x1, 4-pin							
Display							
L LED							
Protective circuit							
- Without holding current reduction (HCR)							
R With holding current reduction (HCR)							
Electrical connection box							
H2 Connection pattern H, horizontal plug connector							
H3 Connection pattern H, vertical plug connector							
S2 Connection pattern S, horizontal plug connector							
S3 Connection pattern S, vertical plug connector							
L1...4 with 2x flying leads L: 1 = 0.5 m, 2 = 1 m, 3 = 2.5 m, 4 = 5 m							
K6...9 Cable: K6 = 0.5 m, K7 = 1 m, K8 = 2.5 m, K9 = 5 m							
R1 Individual plug connector M8, 4-pin							
R8 Individual plug connector M8, 3-pin							
P3 Without electrical connection box							
Operating voltage							
1 24 V DC							
5 12 V DC							
4 5 V DC							
Pneumatic connection							
F In the manifold rail							

Solenoid valves VUVG-BK10, sub-base valves M5/M7

Technical data

Function
 2x 3/2C
 5/2-way, single solenoid
 5/2-way, double solenoid valve

-  - Valve size 10 mm
-  - Flow rate
160 l/min
-  - Voltage
24 V DC

Circuit symbol → Page 13

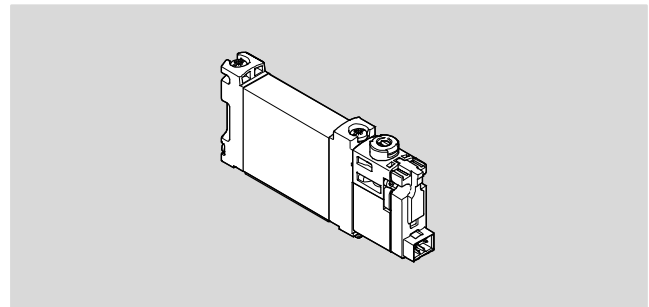

General technical data, VUVG-BK			
Valve function	T32-A	M52-A	B52
Normal position	C ¹⁾	–	–
Stable positions	Monostable		Bistable
Reset method: pneumatic spring	Yes	Yes	–
Design	Piston spool		
Sealing principle	Soft		
Actuation type	Electrical		
Type of control	Pilot		
Pilot air supply	Internal		
Exhaust air function	With flow control		
Manual override	Non-detenting, detenting		
Type of mounting	On manifold rail		
Mounting position	Any		
Standard nominal flow rate	[l/min] 160	160	160
Switching time on/off	[ms] 12/14	14/17	–
Changeover time	[ms] –		7
Valve size	[mm] 10		
Port	2, 4	M5/M7 in manifold rail	
Product weight	[g] 55	45	57
Corrosion resistance class CRC ²⁾	2		

1) C=Normally closed

2) Corrosion resistance class CRC 2 to Festo standard FN 940070
 Moderate corrosion stress. Indoor applications in which condensation may occur. External visible parts with primarily decorative requirements for the surface and which are in direct contact with the ambient atmosphere typical for industrial applications.

Safety data	
Max. positive test pulse with 0 signal	[μs] 1600
Max. negative test pulse with 1 signal	[μs] 3000
Shock resistance	Shock test with severity level 1 to FN 942017-5 and EN 60068-2-27
Vibration resistance	Transport application test with severity level 1 to FN 942017-4 and EN 60068-2-6

Solenoid valves VUVG-BK10, sub-base valves M5/M7

Technical data

Operating and environmental conditions				
Valve function		T32-A ¹⁾	M52-A ¹⁾	B52
Operating medium	Compressed air in accordance with ISO 8573-2010 [7:4:4]			
Note on operating/pilot medium	Lubricated operation possible (in which case lubricated operation will always be required)			
Operating pressure	[bar]	1.5 ... 7	2.5 ... 7	1.5 ... 7
Ambient temperature	[°C]	-5 ... +50		
Temperature of medium	[°C]	-5 ... +50		

1) Pneumatic spring

Electrical data	
Electrical connection	Via electrical connection box → Page 103
Operating voltage	[V DC] 24 ±10%
Nominal operating voltage	[V DC] 22
Power	[W] 0.7
Duty cycle	[%] 100
Degree of protection to EN 60529	IP40 (with plug socket), IP65 (with M8)
Signal status display	LED
Maximum switching frequency	[Hz] 2

Information on materials	
Housing	Wrought aluminium alloy
Seals	HNBR, NBR
Note on materials	RoHS compliant
	Contains paint-wetting impairment substances

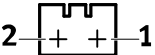
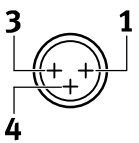
Pin allocation for electrical connection box			
	Pin		Description
Rectangular plug connector, plug pattern H			
	1	+ or -	Protective circuit without holding current reduction
	2	+ or -	
Round plug connector, M8, 3-pin			
	1	Not used	Protective circuit without holding current reduction
	3	+ or -	
	4	+ or -	

Protective circuit without holding current reduction

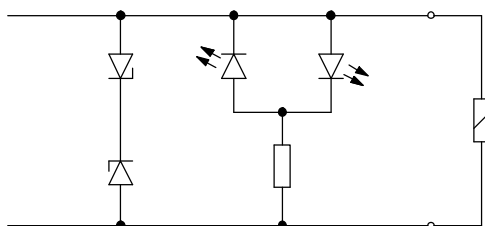

The solenoid coils are equipped with a protective circuit to arrest sparks and protect against polarity reversal.

Solenoid valves VUVG-BK10, sub-base valves M5/M7

Technical data

Dimensions

Download CAD data → www.festo.com

2x 3/2-way, 5/2-way valve, double solenoid

5/2 way valve, single solenoid



Note
 More dimensions
 Electrical connection boxes
 → Page 105

2 Horizontal electrical connection 3 Manual override

Type	B1	H1	L1	L2	L7
VUVG-BK10-T32C-...	10.2	33.6	98.3	95.8	47
VUVG-BK10-B52-...					
VUVG-BK10-M52-...			75.9	74.6	

Solenoid valves VUVG-BK10, sub-base valves M5/M7

FESTO

Ordering data

★ Core product range

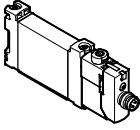
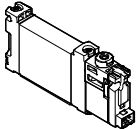
Ordering data			
	Description	Part No.	Type
Sub-base valve M5/M7, with electrical connection box R8			
	2x 3/2-way valve		
	Internal pilot air supply	Normally closed, reset method: pneumatic spring	★ 8042558 VUVG-BK10-T32C-AT-F-1R8L-S
	5/2-way valve, single solenoid		
	Internal pilot air supply	Reset method: pneumatic spring	★ 8042559 VUVG-BK10-M52-AT-F-1R8L-S
	5/2-way valve, double solenoid		
	Internal pilot air supply	★ 8042560	VUVG-BK10-B52-T-F-1R8L-S
Sub-base valve M5/M7, with electrical connection box H2			
	2x 3/2-way valve		
	Internal pilot air supply	Normally closed, reset method: pneumatic spring	★ 8042554 VUVG-BK10-T32C-AT-F-1H2L-S
	5/2-way valve, single solenoid		
	Internal pilot air supply	Reset method: pneumatic spring	★ 8042555 VUVG-BK10-M52-AT-F-1H2L-S
	5/2-way valve, double solenoid		
	Internal pilot air supply	★ 8042556	VUVG-BK10-B52-T-F-1H2L-S

Festo core product range

- ★ Ready for dispatch from the Festo factory in 24 hours
- ☆ Ready for dispatch in 5 days maximum from stock



Solenoid valves VUVG-B10, sub-base valve M5/M7

Technical data

Function

2x 3/2C, 2x 3/2U, 2x 3/2H
 5/2-way, single solenoid
 5/2-way, double solenoid
 5/3C, 5/3U, 5/3E

Circuit symbol → Page 13

-  - Valve size 10 mm
-  - Flow rate
120 ... 270 l/min
-  - Voltage
5, 12 and 24 V DC

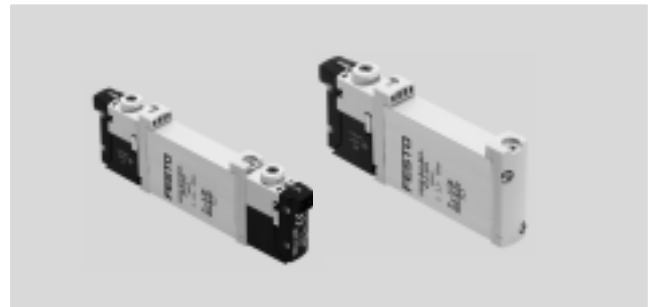

General technical data, VUVG-B M5/M7													
Valve function	T32-A			T32-M			M52-R	B52	M52-M	P53			
Normal position	C ¹⁾	U ²⁾	H ⁴⁾	C ¹⁾	U ²⁾	H ⁴⁾	–	–	–	C ¹⁾	U ²⁾	E ³⁾	
Stable position	Monostable							Bistable	Monostable	Monostable			
Reset method: pneumatic spring	Yes			No			Yes ⁵⁾	–	No	–			
Reset method: mechanical spring	No			Yes			Yes ⁵⁾	–	Yes	–			
Vacuum operation at port 1	No			Only with external pilot air supply									
Design	Piston spool												
Sealing principle	Soft												
Actuation type	Electrical												
Type of control	Pilot												
Pilot air supply	External, internal; can be selected via sub-base												
Exhaust function	With flow control												
Manual override	Choice of non-detenting, covered, non-detenting/detenting or detenting												
Type of mounting	On manifold rail												
Mounting position	Any												
Nominal width	[mm]	2.7		1.8	1.7		4		2.3		3.5		
Standard nominal flow rate	[l/min]	170		150	140		330		285		300		
Flow rate on manifold rail M5	[l/min]	150		130	120		210		180		200		
Flow rate on manifold rail M7	[l/min]	160		140	130		270		230		250		
Switching time on/off	[ms]	6/16		8/11			7/19		–	8/24		10/30	
Changeover time	[ms]	–		–			–		7		16		
Valve size	[mm]	10											
Port	1, 3, 5	G1/8 in manifold rail											
	2, 4	M5 or M7 in manifold rail											
	12/14, 82/84	M5 in manifold rail											
Product weight	[g]	55		54		45		55		44		55	
Certification	c UL us - Recognized (OL)												
	c CSA us (OL)												
	RCM												
CE marking (see declaration of conformity) ⁶⁾	In accordance with EU EMC Directive												
Corrosion resistance class CRC ⁷⁾	2												

1) C=Normally closed/mid-position closed
 2) U=Normally open/mid-position pressurised
 3) E=Mid-position exhausted
 4) H=2x 3/2-way valve in one housing with 1x normally closed and 1x normally open
 5) Combined reset method
 6) For information about the applicability of the component see the manufacturer's EC declaration of conformity at: www.festo.com/sp → Certificates.
 If the component is subject to restrictions on usage in residential, office or commercial environments or small businesses, further measures to reduce the emitted interference may be necessary.
 7) Corrosion resistance class CRC 2 to Festo standard FN 940070
 Moderate corrosion stress. Indoor applications in which condensation may occur. External visible parts with primarily decorative requirements for the surface and which are in direct contact with the ambient atmosphere typical for industrial applications.

Solenoid valves VUVG-B10, sub-base valves M5/M7

Technical data

Operating and environmental conditions							
Valve function			T32-A ¹⁾	T32-M ³⁾	M52-R ²⁾	B52	M52-M ³⁾ P53
Operating medium		Compressed air in accordance with ISO 8573-2010 [7:4:4]					
Operating pressure	Internal	[bar]	1.5 ... 8	3 ... 8	2.5 ... 8	1.5 ... 8	3 ... 8
	External	[bar]	1.5 ... 10	-0.9 ... 10			-0.9 ... 10
Pilot pressure ⁴⁾		[bar]	1.5 ... 8	2 ... 8	2.5 ... 8	1.5 ... 8	3 ... 8
Ambient temperature		[°C]	-5 ... +50, with holding current reduction -5 ... +60				
Temperature of medium		[°C]	-5 ... +50, with holding current reduction -5 ... +60				

- 1) Pneumatic spring
- 2) Mixed, pneumatic/mechanical spring
- 3) Mechanical spring
- 4) Minimum pilot pressure 50% of operating pressure

Electrical data	
Electrical connection	Via electrical connection box → Page 103
Operating voltage	[V DC] 5, 12 and 24 ±10%
Power	[W] 1, reduced to 0.35 with holding current reduction
Duty cycle	[%] 100
Degree of protection to EN 60529	IP40 (with plug socket), IP65 (with M8)

Information on materials	
Housing	Wrought aluminium alloy
Seals	HNBR, NBR
Note on materials	RoHS compliant

Dimensions Download CAD data → www.festo.com

2x 3/2-way, 5/2-way and 5/3-way valve

⌀ - Note
More dimensions
Electrical connection boxes
→ Page 105

1 Vertical electrical connection

2 Horizontal electrical connection

3 Manual override

Type	B1	H1	H2	L1	L2	L3	L4	L5	L6	L7
VUVG-B10 -...-F...	10.2	32.5	3.6	86.5	81.5	8	4.85	6.15	69.2	66.7

Solenoid valves VUVG-B10, sub-base valves M5/M7

Ordering data

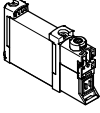
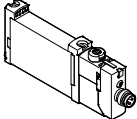
Ordering data					
	Description		Part No.	Type	
Sub-base valve M5/M7, without electrical connection box					
	2x 3/2-way valve				
	External pilot air supply	Normally closed, reset method: pneumatic spring		566487	VUVG-B10-T32C-AZT-F-1P3
		Normally open, reset method: pneumatic spring		566488	VUVG-B10-T32U-AZT-F-1P3
		1x normally open, 1x normally closed, reset method: pneumatic spring		566489	VUVG-B10-T32H-AZT-F-1P3
		Normally closed, reset method: mechanical spring		574364	VUVG-B10-T32C-MZT-F-1P3
		Normally open, reset method: mechanical spring		574365	VUVG-B10-T32U-MZT-F-1P3
		1x normally open, 1x normally closed, reset method: mechanical spring		574366	VUVG-B10-T32H-MZT-F-1P3
	5/2-way valve, single solenoid				
	External pilot air supply	Reset method: pneumatic/mechanical spring		566490	VUVG-B10-M52-RZT-F-1P3
		Reset method: mechanical spring		574367	VUVG-B10-M52-MZT-F-1P3
	5/2-way valve, double solenoid				
	External pilot air supply			566491	VUVG-B10-B52-ZT-F-1P3
	5/3-way valve				
	External pilot air supply	Mid-position closed		566492	VUVG-B10-P53C-ZT-F-1P3
Mid-position exhausted			566493	VUVG-B10-P53E-ZT-F-1P3	
Mid-position pressurised			566494	VUVG-B10-P53U-ZT-F-1P3	
Sub-base valve M5/M7, with electrical connection box R8					
	2x 3/2-way valve				
	External pilot air supply	Normally closed, reset method: pneumatic spring		574234	VUVG-B10-T32C-AZT-F-1R8L
		Normally open, reset method: pneumatic spring		574235	VUVG-B10-T32U-AZT-F-1R8L
		1x normally open, 1x normally closed, reset method: pneumatic spring		574236	VUVG-B10-T32H-AZT-F-1R8L
		Normally closed, reset method: mechanical spring		8031492	VUVG-B10-T32C-MZT-F-1R8L
		Normally open, reset method: mechanical spring		8031493	VUVG-B10-T32U-MZT-F-1R8L
		1x normally open, 1x normally closed, reset method: mechanical spring		8031494	VUVG-B10-T32H-MZT-F-1R8L
	5/2-way valve, single solenoid				
	External pilot air supply	Reset method: pneumatic/mechanical spring		574237	VUVG-B10-M52-RZT-F-1R8L
		Reset method: mechanical spring		578157	VUVG-B10-M52-MZT-F-1R8L
	5/2-way valve, double solenoid				
	External pilot air supply			574238	VUVG-B10-B52-ZT-F-1R8L
	5/3-way valve				
	External pilot air supply	Mid-position closed		574239	VUVG-B10-P53C-ZT-F-1R8L
Mid-position exhausted			574241	VUVG-B10-P53E-ZT-F-1R8L	
Mid-position pressurised			574240	VUVG-B10-P53U-ZT-F-1R8L	

Solenoid valves VUVG-B10, sub-base valves M5/M7

Manifold assembly



Sub-base valve for manifold assembly
M5 or M7 connection



Dimensions

Download CAD data → www.festo.com

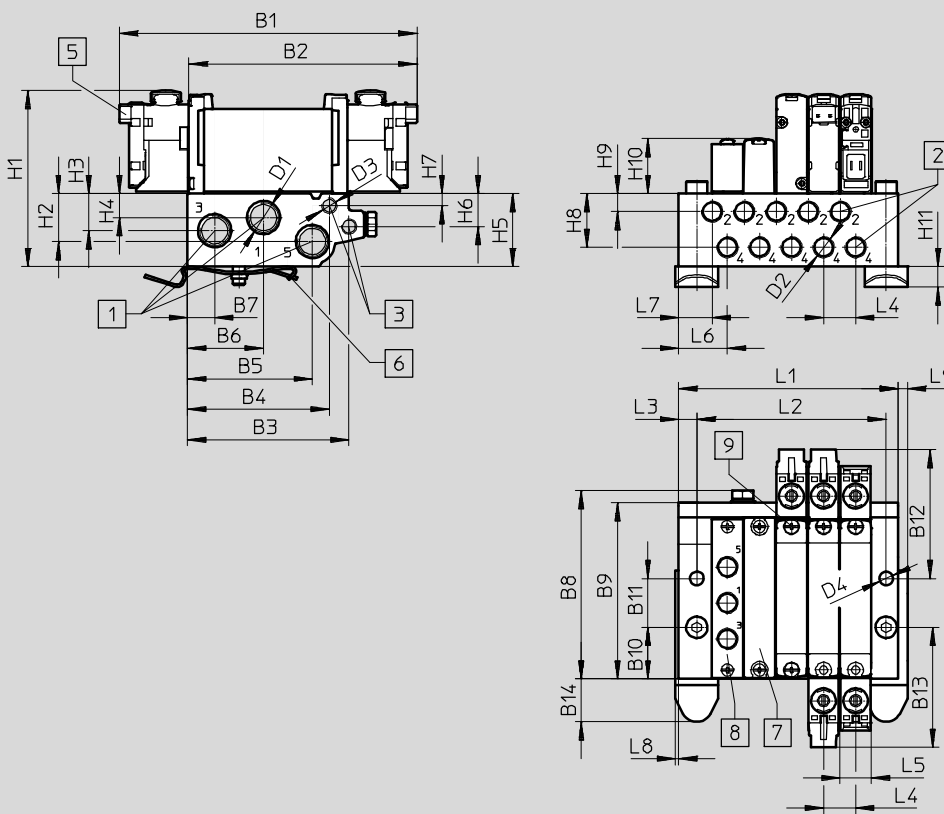

Note
More dimensions
Electrical connection boxes
→ Page 105

- 1 Ports 1, 3 and 5
- 2 Ports 2, 4
- 3 Ports 12, 14
- 5 Electrical connection for electrical connection boxes and accessories
- 6 H-rail mounting (two M4x30 screws are required for mounting)
- 7 Blanking plate
- 8 Supply plate
- 9 Valves/blanking plate mounting on manifold rail

Type	B1	B2	B3	B4	B5	B6	B7	B8	B9	B10	B11	B12
VABM-L1 10-...-G18	97.5	74.8	52.9	46.5	40.9	24.9	8.9	61.7	57.7	16.9	16	42.2

Type	B13	B14	D1	D2	D3	D4	D5	H1	H2	H3	H4
VABM-L1 10-...-G18	39.3	14.1	G1/8	M5/M7	M5	4.5	∅ 6	56.4	15.7	12.2	7.9

Type	H5	H6	H7	H8	H9	H10	H11	L3	L4	L5	L6	L7	L8	L9
VABM-L1 10-...-G18	23.9	10.8	4	17.6	5.9	18	6.8	6	10.5	10.3	16	11.9	1	3

Solenoid valves VUVG-B10, sub-base valves M5/M7

Manifold assembly

Valve positions	2	3	4	5	6	7	8	9	10	12	14	16	22
L1	40.5	51	61.5	72	82.5	93	103.5	114	124.5	145.5	166.5	187.5	250.5
L2	30.5	41	51.5	62	72.5	83	93.5	104	114.5	135.5	156.5	177.5	240.5
VABM weight [g]	107	135	163	191	219	247	275	303	331	387	415	471	499

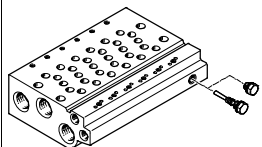
Technical data – Manifold rails ¹⁾									
	Port			CRC	Material ³⁾	Operating pressure [bar]	Max. tightening torque for assembly [Nm]		
	2, 4	1, 3, 5	12/14, 82/84				Valve	H-rail	Wall
	M5 or M7	G1/8	M5	2 ²⁾	Wrought aluminium alloy	-0.9 ... 10	0.45	1.5	3

- 1) Blanking plugs are included with the manifold rail.
- 2) Corrosion resistance class CRC 2 to Festo standard FN 940070
Moderate corrosion stress. Indoor applications in which condensation may occur. External visible parts with primarily decorative requirements for the surface and which are in direct contact with the ambient atmosphere typical for industrial applications.
- 3) Note on materials: RoHS-compliant.

Order code – Manifold rails

VABM	-	L1	-	10	-	G18	-	
Valve manifold parts								Number of valve positions
Manifold rail		VABM						2 to 10, 12, 14 and 16
Valve series								Ports 1, 3, 5
VUVG		L1				G18		G1/8 thread
Valve size								
10 mm				10				
Manifold rail with ports 1, 2, 3, 4, 5, 12/14, 82/84								
Port 2 and 4 with M5 thread								
W								
Port 2 and 4 with M7 thread								
HW								

Ordering data – Manifold rails

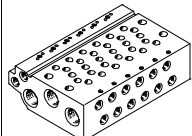
	Description	Part No.	Type
Manifold rail for sub-base valve M5/M7			
	For size B10 (M5)	2 valve positions	★ 566582 VABM-L1-10W-G18-2
		3 valve positions	★ 566583 VABM-L1-10W-G18-3
		4 valve positions	★ 566584 VABM-L1-10W-G18-4
		5 valve positions	566585 VABM-L1-10W-G18-5
		6 valve positions	★ 566586 VABM-L1-10W-G18-6
		7 valve positions	566587 VABM-L1-10W-G18-7
		8 valve positions	★ 566588 VABM-L1-10W-G18-8
		9 valve positions	566589 VABM-L1-10W-G18-9
		10 valve positions	★ 566590 VABM-L1-10W-G18-10
		12 valve positions	566591 VABM-L1-10W-G18-12
		14 valve positions	566592 VABM-L1-10W-G18-14
		16 valve positions	566593 VABM-L1-10W-G18-16





Festo core product range

- ★ Ready for dispatch from the Festo factory in 24 hours
- ☆ Ready for dispatch in 5 days maximum from stock

Solenoid valves VUVG-B10, sub-base valves M5/M7

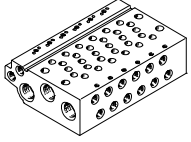
FESTO

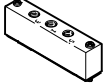
Manifold assembly

Ordering data – Accessories			
	Description	Part No.	Type
Manifold rail for sub-base valve M5/M7			
	For size B10 (M7)	2 valve positions	★ 566606 VABM-L1-10HW-G18-2
		3 valve positions	★ 566607 VABM-L1-10HW-G18-3
		4 valve positions	★ 566608 VABM-L1-10HW-G18-4
		5 valve positions	566609 VABM-L1-10HW-G18-5
		6 valve positions	★ 566610 VABM-L1-10HW-G18-6
		7 valve positions	566611 VABM-L1-10HW-G18-7
		8 valve positions	★ 566612 VABM-L1-10HW-G18-8
		9 valve positions	566613 VABM-L1-10HW-G18-9
		10 valve positions	★ 566614 VABM-L1-10HW-G18-10
		12 valve positions	566615 VABM-L1-10HW-G18-12
		14 valve positions	566616 VABM-L1-10HW-G18-14
		16 valve positions	566617 VABM-L1-10HW-G18-16
Blanking plate Technical data → Internet: vabb			
	For valve position on manifold rail, including screws and seal	★ 566495	VABB-L1-10-W
Separator Technical data → Internet: vabd			
	For creating pressure zones	569994	VABD-6-B
Supply plate Technical data → Internet: vabf			
	For valve position (sub-base valves M5) on manifold rail, including screws and seal	569991	VABF-L1-10-P3A4-M5
	For valve position (sub-base valves M7) on manifold rail, including screws and seal	569992	VABF-L1-10-P3A4-M7
Seals Technical data → Internet: vabd			
	For sub-base valves M5/M7	Delivery unit: 10 sets (each with 2 screws and 1 seal)	566674 VABD-L1-10B-S-M7

Festo core product range

★ Ready for dispatch from the Festo factory in 24 hours

☆ Ready for dispatch in 5 days maximum from stock

Solenoid valves VUVG, sub-base valves G1/8

Order code



VUVG	-	B	14	-	-	-	Z	
Type of directional control valve								
Sub-base, manifold valve incl. seal and screws								
B								
Design principle								
Piston spool with sealing cartridge								
-								
Piston spool with sealing ring								
K								
Valve size								
14 mm 14								
Valve functions								
						T32C		
						T32U		
						T32H		
						M52		
						B52		
						P53C		
						P53U		
						P53E		
Reset method								
Pneumatic spring with T32 and M52								
A								
Mechanical spring with T32 and M52								
M								
With B52 and P53								
-								
Pilot air supply								
External								
Z								
Manual override								
Non-detenting								
H								
Covered								
S								
Non-detenting, detenting								
T								
Detenting, without accessories								
Y								

F	-	-	-	L	-	-	-
Version							
- Extended features							
S Core features							
Connecting cables							
W1...4		Not sheathed					
C1...4		Sheathed					
WS1...4		Not sheathed					
S1...4		Sheathed					
N1...4		M8x1, 3-pin					
N5...8		M8x1, 4-pin					
Display							
L LED							
Protective circuit							
- Without holding current reduction (HCR)							
R With holding current reduction (HCR)							
Electrical connection box							
H2		Connection pattern H, horizontal plug connector					
H3		Connection pattern H, vertical plug connector					
S2		Connection pattern S, horizontal plug connector					
S3		Connection pattern S, vertical plug connector					
L1...4		With 2x flying leads L: 1 = 0.5 m, 2 = 1 m, 3 = 2.5 m, 4 = 5 m					
K6...9		Cable: K6 = 0.5 m, K7 = 1 m, K8 = 2.5 m, K9 = 5 m					
R1		Individual plug connector M8, 4-pin					
R8		Individual plug connector M8, 3-pin					
P3		Without electrical connection box					
Operating voltage							
1		24 V DC					
5		12 V DC					
4		5 V DC					
Pneumatic connection							
F		In the manifold rail					

Solenoid valves VUVG-BK14, sub-base valves G1/8

Technical data

Function
 2x 3/2C
 5/2-way, single solenoid
 5/2-way, double solenoid valve

-  - Valve size 14 mm
-  - Flow rate
350 ... 380 l/min
-  - Voltage
24 V DC

Circuit symbol → Page 13

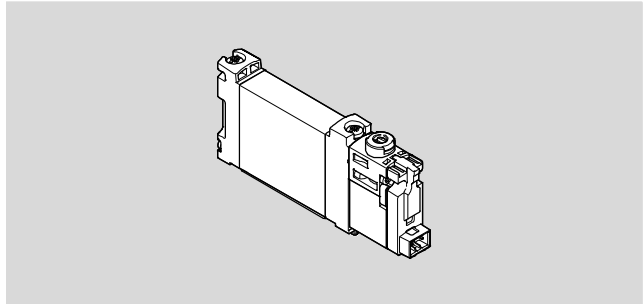

General technical data, VUVG-BK			
Valve function	T32-A	M52-A	B52
Normal position	C ¹⁾	-	-
Stable positions	Monostable		Bistable
Reset method: pneumatic spring	Yes	Yes	-
Design	Piston spool		
Sealing principle	Soft		
Type of control	Electrical		
Type of actuation	Pilot		
Pilot air supply port	Internal		
Exhaust air function	With flow control		
Manual override	Non-detenting, detenting		
Type of mounting	On manifold rail		
Assembly position	Any		
Nominal standard flow rate	[l/min.] 350	380	380
Switching time on/off	[ms] 13/20	14/24	-
Changeover time	[ms] -		8
Valve size	[mm] 14		
Connection	2, 4	G1/8 in manifold rail	
Product weight	[g] 75	65	85
Corrosion resistance class CRC ²⁾	2		

1) C=Normally closed

2) Corrosion resistance class CRC 2 to Festo standard FN 940070
 Moderate corrosion stress. Indoor applications in which condensation may occur. External visible parts with primarily decorative requirements for the surface and which are in direct contact with the ambient atmosphere typical for industrial applications.

Safety data	
Max. positive test pulse with 0 signal	[µs] 1600
Max. negative test pulse with 1 signal	[µs] 3000
Resistance to shocks	Shock test with severity level 1 to FN 942017-5 and EN 60068-2-27
Vibration resistance	Transport application test with severity level 1 to FN 942017-4 and EN 60068-2-6

Solenoid valves VUVG-BK14, sub-base valves G1/8

Technical data

Operating and environmental conditions				
Valve function		T32-A ¹⁾	M52-A ¹⁾	B52
Operating medium	Compressed air in accordance with ISO 8573-2010 [7:4:4]			
Note on operating/pilot medium	Lubricated operation possible (in which case lubricated operation will always be required)			
Operating pressure	[bar]	1.5 ... 7	2.5 ... 7	1.5 ... 7
Ambient temperature	[°C]	-5 ... +50		
Temperature of medium	[°C]	-5 ... +50		

1) Pneumatic spring.

Electrical data	
Electrical connection	Via electrical connection box → Page 103
Operating voltage	[V DC] 24 ±10%
Nominal operating voltage	[V DC] 22
Performance	[W] 0.7
Duty cycle	[%] 100
Degree of protection to EN 60529	IP40 (with plug socket), IP65 (with M8)
Signal status display	LED
Maximum switching frequency	[Hz] 2

Information on materials	
Housing	Wrought aluminum alloy
Seals	HNBR, NBR
Note on materials	RoHS compliant
	Contains paint-wetting impairment substances

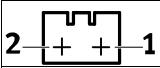
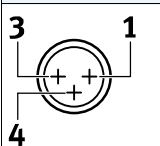
Pin allocation for electrical connection box			
	Pin		Description
Rectangular plug connector, connection pattern H			
	1	+ or -	Protective circuit without holding current reduction
	2	+ or -	
Round plug, M8, 3-pin			
	1	Not used	Protective circuit without holding current reduction
	3	+ or -	
	4	+ or -	

Protective circuit without holding current reduction

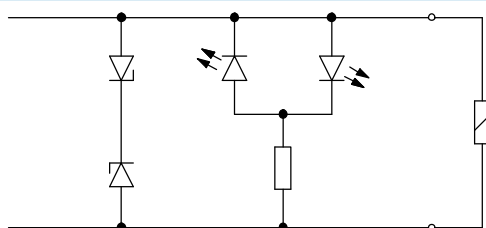

The solenoid coils are equipped with a protective circuit to arrest sparks and protect against polarity reversal.

Solenoid valves VUVG-BK14, sub-base valves G1/8

Technical data

Dimensions Download CAD data → www.festo.com

2x 3/2-way, 5/2-way valve, single solenoid 5/2-way valve, double solenoid

2 Horizontal electrical connection
 3 Manual override

Note
 More dimensions
 Electrical connection boxes
 → Page 105

Type	B1	H1	L1	L2	L7
VUVG-BK14-T32C-...	14.4	34.8	118.9	116.4	66.5
VUVG-BK14-B52-...					
VUVG-BK14-M52-...			95.6	94.4	

Solenoid valves VUVG-BK14, sub-base valves G1/8

Ordering data

★ Core product range

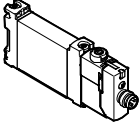
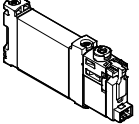
Ordering data		Description	Part No.	Type
Sub-base valve G1/8, with electrical connection box R8				
	2x 3/2-way valve			
	Internal pilot air supply	Normally closed, reset method: pneumatic spring	★ 8042574	VUVG-BK14-T32C-AT-F-1R8L-S
	5/2-way valve, single-solenoid			
	Internal pilot air supply	Reset method: pneumatic spring	★ 8042575	VUVG-BK14-M52-AT-F-1R8L-S
	5/2-way valve, double-solenoid			
	Internal pilot air supply		★ 8042576	VUVG-BK14-B52-T-F-1R8L-S
Sub-base valve G1/8, with electrical connection box H2				
	2x 3/2-way valve			
	Internal pilot air supply	Normally closed, reset method: pneumatic spring	★ 8042570	VUVG-BK14-T32C-AT-F-1H2L-S
	5/2-way valve, single-solenoid			
	Internal pilot air supply	Reset method: pneumatic spring	★ 8042571	VUVG-BK14-M52-AT-F-1H2L-S
	5/2-way valve, double-solenoid			
	Internal pilot air supply		★ 8042572	VUVG-BK14-B52-T-F-1H2L-S

Festo core product range

- ★ Ready for dispatch from the Festo factory in 24 hours
- ☆ Ready for dispatch in 5 days maximum from stock



Solenoid valves VUVG-B14, sub-base valves G1/8

Technical data

Function

2x 3/2C, 2 x3/2U, 2 x3/2
5/2-way, single solenoid
5/2-way valve, double solenoid
5/3C, 5/3U, 5/3E

Circuit symbol → Page 13

-  - Valve size 14 mm
-  - Flow rate
410 ... 580 l/min
-  - Voltage
5, 12 and 24 V DC

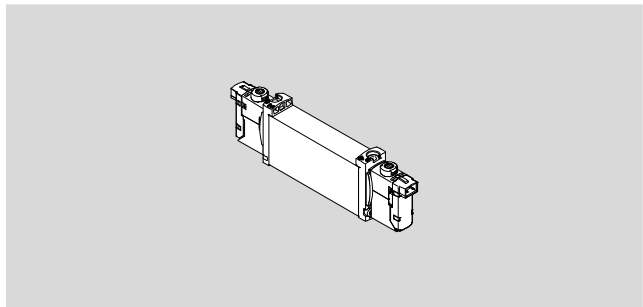

General technical data, VUVG-B G1/8													
Valve function	T32-A			T32-M			M52-A	B52	M52-M	P53			
Normal position	C ¹⁾	U ²⁾	H ⁴⁾	C ¹⁾	U ²⁾	H ⁴⁾	–	–	–	C ¹⁾	U ²⁾	E ³⁾	
Stable position	Monostable							Bistable	Monostable	Monostable			
Reset method: pneumatic spring	Yes			No			Yes	–	No	–			
Reset method: mechanical spring	No			Yes			No	–	Yes	–			
Vacuum operation at port 1	No			Only with external pilot air supply									
Design	Piston spool												
Sealing principle	Soft												
Actuation type	Electrical												
Type of control	Pilot												
Pilot air supply	External, internal; can be selected via sub-base												
Exhaust function	With flow control												
Manual override	Choice of non-detenting, covered, non-detenting/detenting or detenting												
Type of mounting	On manifold rail												
Mounting position	Any												
Nominal width	[mm]	4.6			4.3			5.4					
Standard nominal flow rate	[l/min]	600	580		470	450	450	630	680		600	580	580
Flow rate on manifold rail G1/8	[l/min]	540	510	540	430	410	410	520	580		540	510	510
Switching time on/off	[ms]	8/23			11/15			14/22	–	13/40		12/40	
Changeover time	[ms]	–							8		20		
Valve size	[mm]	14											
Port	1, 3, 5	G1/4 in manifold rail											
	2, 4	G1/8 in manifold rail											
	12/14, 82/84	M5 in manifold rail											
Product weight	[g]	89			80			78	89	70	89		
Certification	c UL us - Recognized (OL)												
	c CSA us (OL)												
	RCM												
CE marking (see declaration of conformity) ⁵⁾	In accordance with EU EMC Directive												
Corrosion resistance class CRC ⁶⁾	2												

1) C=Normally closed/mid-position closed
 2) U=Normally open/mid-position pressurised
 3) E=Mid-position exhausted
 4) H=2x 3/2-way valve in one housing with 1x normally closed and 1x normally open
 5) For information about the applicability of the component see the manufacturer's EC declaration of conformity at: www.festo.com/sp → Certificates.
 If the component is subject to restrictions on usage in residential, office or commercial environments or small businesses, further measures to reduce the emitted interference may be necessary.
 6) Corrosion resistance class CRC 2 to Festo standard FN 940070
 Moderate corrosion stress. Indoor applications in which condensation may occur. External visible parts with primarily decorative requirements for the surface and which are in direct contact with the ambient atmosphere typical for industrial applications.

Solenoid valves VUVG-B14, sub-base valves G1/8

Technical data

Operating and environmental conditions			T32-A ¹⁾	T32-M ²⁾	M52-A ¹⁾	B52	M52-M ²⁾	P53
Valve function			Compressed air in accordance with ISO 8573-2010 [7:4:4]					
Operating pressure	Internal	[bar]	1.5 ... 8	3 ... 8	2.5 ... 8	1.5 ... 8	3 ... 8	
	External	[bar]	1.5 ... 10	-0.9 ... 10			-0.9 ... 8	-0.9 ... 10
Pilot pressure ³⁾		[bar]	1.5 ... 8	2 ... 8	2.5 ... 8	1.5 ... 8	3 ... 8	
Ambient temperature		[°C]	-5 ... +50, with holding current reduction -5 ... +60					
Temperature of medium		[°C]	-5 ... +50, with holding current reduction -5 ... +60					

- 1) Pneumatic spring
- 2) Mechanical spring
- 3) Minimum pilot pressure 50% of operating pressure

Electrical data	
Electrical connection	Via electrical connection box → Page 103
Operating voltage	[V DC] 5, 12 and 24 ±10%
Power	[W] 1, reduced to 0.35 with holding current reduction
Duty cycle	[%] 100
Degree of protection to EN 60529	IP40 (with plug socket), IP65 (with M8)

Information on materials	
Housing	Wrought aluminium alloy
Seals	HNBR, NBR
Note on materials	RoHS compliant

Dimensions Download CAD data → www.festo.com

2x 3/2-way, 5/2-way and 5/3-way valve

- - Note
 More dimensions
 Electrical connection boxes
 → Page 105

1 Horizontal electrical connection
 2 Manual override

Type	B1	H1	L1	L2	L3	L4	L5	L6	L7	L8
VUVG-B14 -...-F ...	14.4	34.8	107	102	8	66.5	4.85	6.15	89.45	86.95

Solenoid valves VUVG-B14, sub-base valves G1/8

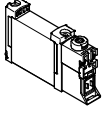
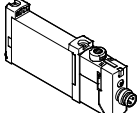

Ordering data

Ordering data					
Description		Part No.	Type		
Sub-base valve G1/8, without electrical connection box					
	2x 3/2-way valve				
	External pilot air supply	Normally closed, reset method: pneumatic spring	566513	VUVG-B14-T32C-AZT-F-1P3	
		Normally open, reset method: pneumatic spring	566514	VUVG-B14-T32U-AZT-F-1P3	
		1x normally open, 1x normally closed, reset method: pneumatic spring	566515	VUVG-B14-T32H-AZT-F-1P3	
		Normally closed, reset method: mechanical spring	574376	VUVG-B14-T32C-MZT-F-1P3	
		Normally open, reset method: mechanical spring	574377	VUVG-B14-T32U-MZT-F-1P3	
		1x normally open, 1x normally closed, reset method: mechanical spring	574378	VUVG-B14-T32H-MZT-F-1P3	
	5/2-way valve, single solenoid				
	External pilot air supply	Reset method: pneumatic spring	566516	VUVG-B14-M52-AZT-F-1P3	
		Reset method: mechanical spring	574379	VUVG-B14-M52-MZT-F-1P3	
	5/2-way valve, double solenoid				
	External pilot air supply		566517	VUVG-B14-B52-ZT-F-1P3	
	5/3-way valve				
External pilot air supply	Mid-position closed	566518	VUVG-B14-P53C-ZT-F-1P3		
	Mid-position exhausted	566519	VUVG-B14-P53E-ZT-F-1P3		
	Mid-position pressurised	566520	VUVG-B14-P53U-ZT-F-1P3		
Sub-base valve G1/8, with electrical connection box R8					
	2x 3/2-way valve				
	External pilot air supply	Normally closed, reset method: pneumatic spring	574242	VUVG-B14-T32C-AZT-F-1R8L	
		Normally open, reset method: pneumatic spring	574243	VUVG-B14-T32U-AZT-F-1R8L	
		1x normally open, 1x normally closed, reset method: pneumatic spring	574244	VUVG-B14-T32H-AZT-F-1R8L	
		Normally closed, reset method: mechanical spring	578248	VUVG-B14-T32C-MZT-F-1R8L	
		Normally open, reset method: mechanical spring	8031517	VUVG-B14-T32U-MZT-F-1R8L	
		1x normally open, 1x normally closed, reset method: mechanical spring	8031518	VUVG-B14-T32H-MZT-F-1R8L	
	5/2-way valve, single solenoid				
	External pilot air supply	Reset method: pneumatic spring	574245	VUVG-B14-M52-AZT-F-1R8L	
		Reset method: mechanical spring	578158	VUVG-B14-M52-MZT-F-1R8L	
	5/2-way valve, double solenoid				
	External pilot air supply		574246	VUVG-B14-B52-ZT-F-1R8L	
	5/3-way valve				
	External pilot air supply	Mid-position closed	574247	VUVG-B14-P53C-ZT-F-1R8L	
		Mid-position exhausted	574249	VUVG-B14-P53E-ZT-F-1R8L	
		Mid-position pressurised	574248	VUVG-B14-P53U-ZT-F-1R8L	

Solenoid valves VUVG-B14, sub-base valves G1/8

Manifold assembly

Sub-base valve for manifold assembly
Connection G1/8

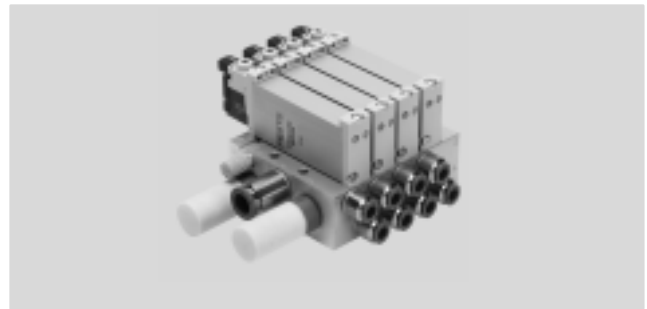

Dimensions

Download CAD data → www.festo.com

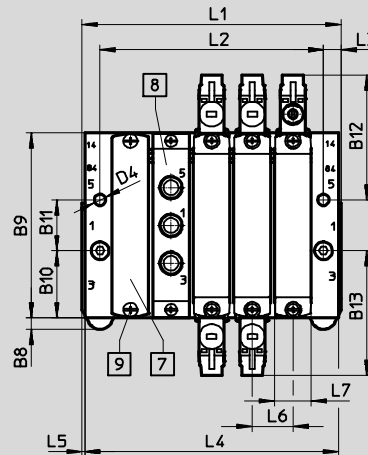
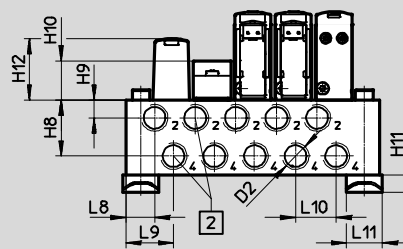
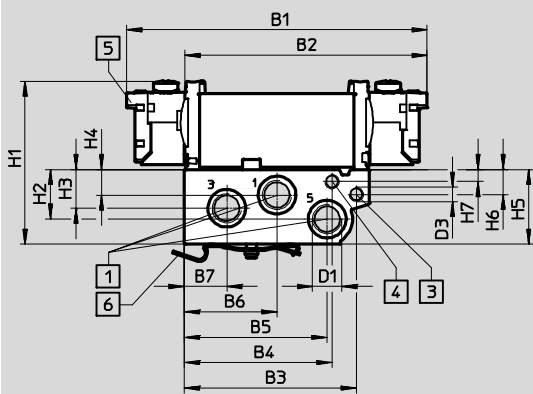

- - Note
More dimensions
Electrical connection boxes
→ Page 105

- 1 Ports 1, 3 and 5
- 2 Ports 2, 4
- 3 Ports 12, 14
- 4 Ports 82, 84
- 5 Electrical connection for electrical connection boxes and accessories
- 6 H-rail mounting (two M4x35 screws are required for mounting)
- 7 Blanking plate
- 8 Supply plate
- 9 Valves/blanking plate mounting on manifold rail

Type	B1	B2	B3	B4	B5	B6	B7	B8	B9	B10	B11	B12
VABM-L1-14W-G14	118.3	95.1	67.7	58.2	56.3	36.6	16.7	4.5	72.9	26.5	20	49.1

Type	B13	D1	D2	D3	D4	H1	H2	H3	H4	H5
VABM-L1-14W-G14	49.1	G1/4	G1/8	M5	∅ 4.5	64.3	19.6	15.3	10.1	29.5

Type	H6	H7	H8	H9	H10	H11	H12	L3	L5	L6	L7	L8	L9	L10	L11
VABM-L1-14W-G14	9.8	4.8	22.1	7	15.4	6.8	23.9	6	1	16	14.4	11.3	18.5	16	14

Solenoid valves VUVG-B14, sub-base valves G1/8

Ordering data

Valve positions	2	3	4	5	6	7	8	9	10	12	14	16
L1	56.3	72.3	88.3	104.3	120.3	136.3	152.3	168.3	184.3	216.3	248.3	280.3
L2	40	56	72	88	104	120	136	152	168	200	232	264
L4	54.3	70.3	86.3	102.3	118.3	134.3	150.3	166.3	182.3	214.3	246.6	278.3
VABM weight [g]	232	306	380	454	528	602	676	750	824	972	1120	1268

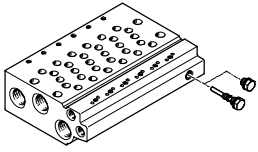
Technical data – Manifold rails ¹⁾									
	Port			CRC	Material ³⁾	Operating pressure [bar]	Max. tightening torque for assembly [Nm]		
	2, 4	1, 3, 5	12/14, 82/84				Valve	H-rail	Wall
	G1/8	G1/4	M5	2 ²⁾	Wrought aluminium alloy	-0.9 ... 10	0.65	1.5	3

- 1) Blanking plugs are included with the manifold rail.
- 2) Corrosion resistance class CRC 2 to Festo standard FN 940070
Moderate corrosion stress. Indoor applications in which condensation may occur. External visible parts with primarily decorative requirements for the surface and which are in direct contact with the ambient atmosphere typical for industrial applications.
- 3) Note on materials: RoHS-compliant.

Order code – Manifold rails

VABM	-	L1	-	14	W	-	G14	-	
Manifold assembly parts									Number of valve positions
Manifold rail		VABM							2 to 10, 12, 14 and 16
Valve series									Ports 1, 3, 5
VUVG		L1					G14		G1/4 thread
Valve size									
14 mm					14				
Manifold rail with ports 1, 2, 3, 4, 5, 12/14, 82/84									
Port 2 and 4 with G1/8 thread					W				

Ordering data – Manifold rail

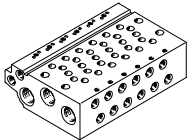

Description	Part No.	Type	
Manifold rail for sub-base valve G1/8			
	For size B14 (G1/8)		
	2 valve positions	★ 566642	VABM-L1-14W-G14-2
	3 valve positions	★ 566643	VABM-L1-14W-G14-3
	4 valve positions	★ 566644	VABM-L1-14W-G14-4
	5 valve positions	566645	VABM-L1-14W-G14-5
	6 valve positions	★ 566646	VABM-L1-14W-G14-6
	7 valve positions	566647	VABM-L1-14W-G14-7
	8 valve positions	★ 566648	VABM-L1-14W-G14-8
	9 valve positions	566649	VABM-L1-14W-G14-9
	10 valve positions	★ 566650	VABM-L1-14W-G14-10
12 valve positions	566651	VABM-L1-14W-G14-12	
14 valve positions	566652	VABM-L1-14W-G14-14	
16 valve positions	566653	VABM-L1-14W-G14-16	

Festo core product range

- ★ Ready for dispatch from the Festo factory in 24 hours
- ☆ Ready for dispatch in 5 days maximum from stock

Solenoid valves VUVG-B14, sub-base valves G1/8

Ordering data

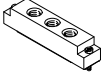
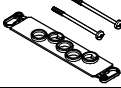
Ordering data – Accessories			
	Description	Part No.	Type
Blanking plate Technical data → Internet: vabb			
	For valve position on manifold rail, including screws and seal	★ 569989	VABB-L1-14
Separator Technical data → Internet: vabd			
	For creating pressure zones	569996	VABD-10-B
Supply plate Technical data → Internet: vabf			
	For valve position on manifold rail, including screws and seal	569993	VABF-L1-14-P3A4-G18
Seals Technical data → Internet: vabd			
	For sub-base valves G1/8	Delivery unit: 10 sets (each with 2 screws and 1 seal)	566676 VABD-L1-14B-S-G18



Festo core product range

- ★ Ready for dispatch from the Festo factory in 24 hours
- ☆ Ready for dispatch in 5 days maximum from stock

Solenoid valves VUVG, sub-base valves G1/4

Order code

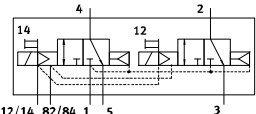
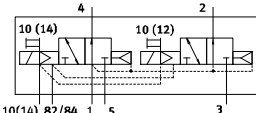
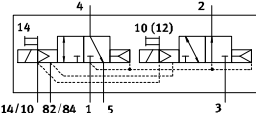
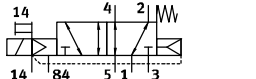
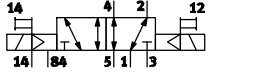
FESTO

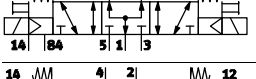
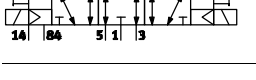
VUVG	-	B	18	-	-	-	Z	
Type of directional control valve								
Sub-base, manifold valve incl. seal and screws		B						
Design principle								
Piston spool with sealing cartridge		-						
Valve size								
18 mm		18						
Valve functions								
		T32C						
		T32U						
		T32H						
		M52						
		B52						
		P53C						
		P53U						
		P53E						
Reset method								
Pneumatic spring with T32 and M52		A						
Mechanical spring with T32 and M52		M						
Pneu./mech. spring with M52		R						
With B52 and P53		-						
Pilot air supply								
External		Z						
Manual override								
Non-detenting		H						
Covered		S						
Non-detenting, detenting		T						
Detenting, without accessories		Y						

F	-							
Connecting cables								
W1...4		Not sheathed						
C1...4		Sheathed						
WS1...4		Not sheathed						
S1...4		Sheathed						
N1...4		M8x1, 3-pin						
N5...8		M8x1, 4-pin						
Display								
L		LED						
Protective circuit								
-		Without holding current reduction (HCR)						
R		With holding current reduction (HCR)						
Electrical connection box								
H2		Connection pattern H, horizontal plug connector						
H3		Connection pattern H, vertical plug connector						
S2		Connection pattern S, horizontal plug connector						
S3		Connection pattern S, vertical plug connector						
L1...4		With 2x flying leads L: 1 = 0.5 m, 2 = 1 m, 3 = 2.5 m, 4 = 5 m						
K6...9		Cable: K6 = 0.5 m, K7 = 1 m, K8 = 2.5 m, K9 = 5 m						
R1		Individual plug connector M8, 4-pin						
R8		Individual plug connector M8, 3-pin						
P3		Without electrical connection box						
Operating voltage								
1		24 V DC						
5		12 V DC						
4		5 V DC						
Pneumatic connection								
F		In the manifold rail						



Solenoid valves VUVG-B18, sub-base valves G1/4

Technical data

Function

2x 3/2C, 2x 3/2U, 2x 3/2H
 5/2-way, single solenoid
 5/2-way valve, double solenoid
 5/3C, 5/3U, 5/3E

Circuit symbol → Page 13

-  - Valve size 18 mm
-  - Flow rate
800 ... 1080 l/min
-  - Voltage
5, 12 and 24 V DC



General technical data, VUVG-B G1/4												
Valve function	T32-A			T32-M			M52-R	B52	M52-M	P53		
Normal position	C ¹⁾	U ²⁾	H ⁴⁾	C ¹⁾	U ²⁾	H ⁴⁾	–	–	–	C ¹⁾	U ²⁾	E ³⁾
Stable position	Monostable							Bistable	Monostable	Monostable		
Reset method: pneumatic spring	Yes			No			Yes ⁵⁾	–	No	–		
Reset method: mechanical spring	No			Yes			Yes ⁵⁾	–	Yes	–		
Vacuum operation at port 1	No			Only with external pilot air supply								
Design	Piston spool											
Sealing principle	Soft											
Actuation type	Electrical											
Type of control	Pilot											
Pilot air supply	External, internal; can be selected via sub-base											
Exhaust function	With flow control											
Manual override	Choice of non-detenting, covered, non-detenting/detenting or detenting											
Type of mounting	On manifold rail											
Mounting position	Any											
Nominal width [mm]	5.7			6.9			7.3	6.9			6.5	
Standard nominal flow rate [l/min]	900			1150						1080		
Flow rate on manifold rail	800			1000						950		
Switching time on/off [ms]	13/27			15/22			15/31	–	10/45		15/48	
Changeover time [ms]	–						11					
Valve size [mm]	18											
Port	1, 3, 5			G3/8 in manifold rail								
	2, 4			G1/4 in manifold rail								
	12/14, 82/84			M5 in manifold rail								
Product weight [g]	164			154			160	154		160		
Certification	c UL us - Recognized (OL)											
	c CSA us (OL)											
	RCM											
CE marking (see declaration of conformity) ⁶⁾	In accordance with EU EMC Directive											
Corrosion resistance class CRC ⁷⁾	2											

1) C=Normally closed/mid-position closed
 2) U=Normally open/mid-position pressurised
 3) E=Mid-position exhausted
 4) H=2x 3/2-way valve in one housing with 1x normally closed and 1x normally open
 5) Combined reset method
 6) For information about the applicability of the component see the manufacturer's EC declaration of conformity at: www.festo.com/sp → Certificates.
 If the component is subject to restrictions on usage in residential, office or commercial environments or small businesses, further measures to reduce the emitted interference may be necessary.
 7) Corrosion resistance class CRC 2 to Festo standard FN 940070
 Moderate corrosion stress. Indoor applications in which condensation may occur. External visible parts with primarily decorative requirements for the surface and which are in direct contact with the ambient atmosphere typical for industrial applications.

Solenoid valves VUVG-B18, sub-base valves G1/4

Technical data

Operating and environmental conditions							
Valve function			T32-A ¹⁾	T32-M ³⁾	M52-R ²⁾	B52	M52-M ³⁾ P53
Operating medium		Compressed air in accordance with ISO 8573-2010 [7:4:4]					
Operating pressure	Internal	[bar]	1.5 ... 8	3.5 ... 8	2.5 ... 8	1.5 ... 8	3 ... 8
	External	[bar]	1.5 ... 10	-0.9 ... 10			-0.9 ... 8
Pilot pressure ⁴⁾		[bar]	1.5 ... 8	3 ... 8	2.5 ... 8	1.5 ... 8	3 ... 8
Ambient temperature		[°C]	-5 ... +50, with holding current reduction -5 ... +60				
Temperature of medium		[°C]	-5 ... +50, with holding current reduction -5 ... +60				

- 1) Pneumatic spring
- 2) Mixed, pneumatic/mechanical spring
- 3) Mechanical spring
- 4) Minimum pilot pressure 50% of operating pressure

Electrical data	
Electrical connection	Via electrical connection box → Page 103
Operating voltage	[V DC] 5, 12 and 24 ±10%
Power	[W] 1, reduced to 0.35 with holding current reduction
Duty cycle	[%] 100
Degree of protection to EN 60529	IP40 (with plug socket), IP65 (with M8)

Information on materials	
Housing	Wrought aluminium alloy
Seals	HNBR, NBR
Note on materials	RoHS compliant

Dimensions Download CAD data → www.festo.com

2x 3/2-way, 5/2-way and 5/3-way valve

1 Horizontal electrical connection 2 Manual override

- - Note
More dimensions
Electrical connection boxes
→ Page 105

Type	B1	H1	L1	L2	L3	L4	L5
VUVG-B18 -...-F...	18.3	43.1	129.4	124.4	86.4	112.2	109.7

Solenoid valves VUVG-B18, sub-base valves G1/4

Ordering data

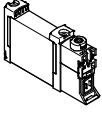
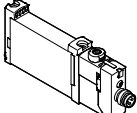
Ordering data					
	Description		Part No.	Type	
Sub-base valve G1/4, without electrical connection box					
	2x 3/2-way valve				
	External pilot air supply	Normally closed, reset method: pneumatic spring		574443	VUVG-B18-T32C-AZT-F-1P3
		Normally open, reset method: pneumatic spring		574444	VUVG-B18-T32U-AZT-F-1P3
		1x normally open, 1x normally closed, reset method: pneumatic spring		574445	VUVG-B18-T32H-AZT-F-1P3
		Normally closed, reset method: mechanical spring		574446	VUVG-B18-T32C-MZT-F-1P3
		Normally open, reset method: mechanical spring		574447	VUVG-B18-T32U-MZT-F-1P3
		1x normally open, 1x normally closed, reset method: mechanical spring		574448	VUVG-B18-T32H-MZT-F-1P3
	5/2-way valve, single solenoid				
	External pilot air supply	Reset method: pneumatic/mechanical spring		574449	VUVG-B18-M52-RZT-F-1P3
		Reset method: mechanical spring		574450	VUVG-B18-M52-MZT-F-1P3
	5/2-way valve, double solenoid				
	External pilot air supply			574451	VUVG-B18-B52-ZT-F-1P3
	5/3-way valve				
	External pilot air supply	Mid-position closed		574452	VUVG-B18-P53C-ZT-F-1P3
Mid-position exhausted			574453	VUVG-B18-P53E-ZT-F-1P3	
Mid-position pressurised			574454	VUVG-B18-P53U-ZT-F-1P3	
Sub-base valve G1/4, with electrical connection box R8					
	2x 3/2-way valve				
	External pilot air supply	Normally closed, reset method: pneumatic spring		8031537	VUVG-B18-T32C-AZT-F-1R8L
		Normally open, reset method: pneumatic spring		8031538	VUVG-B18-T32U-AZT-F-1R8L
		1x normally open, 1x normally closed, reset method: pneumatic spring		8031539	VUVG-B18-T32H-AZT-F-1R8L
		Normally closed, reset method: mechanical spring		8031540	VUVG-B18-T32C-MZT-F-1R8L
		Normally open, reset method: mechanical spring		8031541	VUVG-B18-T32U-MZT-F-1R8L
		1x normally open, 1x normally closed, reset method: mechanical spring		8031542	VUVG-B18-T32H-MZT-F-1R8L
	5/2-way valve, single solenoid				
	External pilot air supply	Reset method: pneumatic/mechanical spring		8031543	VUVG-B18-M52-RZT-F-1R8L
		Reset method: mechanical spring		8031544	VUVG-B18-M52-MZT-F-1R8L
	5/2-way valve, double solenoid				
	External pilot air supply			8031545	VUVG-B18-B52-ZT-F-1R8L
	5/3-way valve				
	External pilot air supply	Mid-position closed		8031546	VUVG-B18-P53C-ZT-F-1R8L
Mid-position exhausted			8031547	VUVG-B18-P53E-ZT-F-1R8L	
Mid-position pressurised			8031548	VUVG-B18-P53U-ZT-F-1R8L	

Solenoid valves VUVG-B18, sub-base valves G1/4



Manifold assembly

Sub-base valve for manifold assembly
Connection G1/4

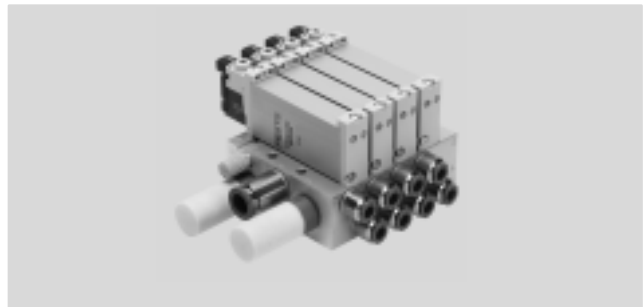

Dimensions

Download CAD data → www.festo.com

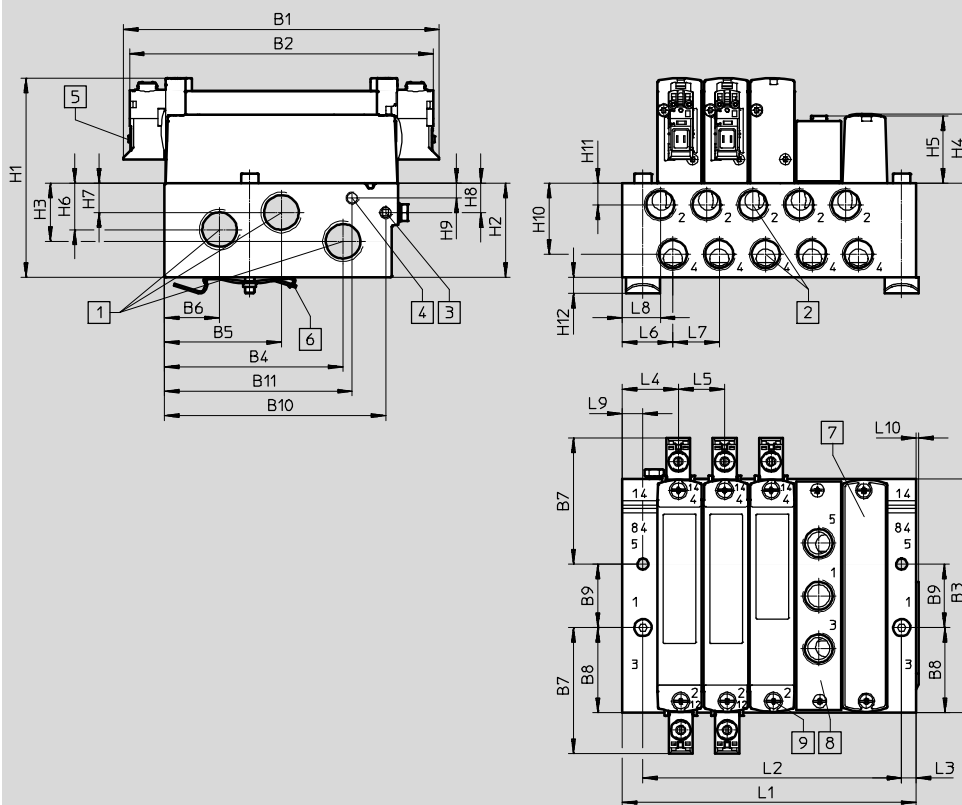

Note
More dimensions
Electrical connection boxes
→ Page 105

- 1 Ports 1, 3 and 5
- 2 Ports 2, 4
- 3 Ports 12, 14
- 4 Ports 82, 84
- 5 Electrical connection for electrical connection boxes and accessories
- 6 H-rail mounting (two M4x40 screws are required for mounting)
- 7 Blanking plate
- 8 Supply plate
- 9 Valves/blanking plate mounting on manifold rail

Type	B1	B2	B3	B4	B5	B6	B7	B8	B9	B10	B11	D1
VABM-L1-18W-G38	129.4	124.4	95.6	73.1	47.8	22.5	51.7	34.8	26	90.6	76.8	4.5

Type	H1	H2	H3	H4	H5	H6	H7	H8	H9	H10	H11	H12
VABM-L1-18W-G38	81.6	38.5	11.5	28.4	27.6	19	12	12.1	6.1	29.1	8.8	6.5

Type	L3	L4	L5	L6	L7	L8	L9	L10
VABM-L1-18W-G38	6	23	19	20.8	19	15.6	8.5	1

Solenoid valves VUVG-B18, sub-base valves G1/4

Ordering data

Valve positions	2	3	4	5	6	7	8	9	10	12	14	16
L1	63.5	82.5	101.5	120.5	139.5	158.5	177.5	196.5	215.5	253.5	291.5	329.5
L2	49	68	87	106	125	144	163	182	201	239	277	315
VABM weight [g]	232	306	380	454	528	602	676	750	824	972	1120	1268

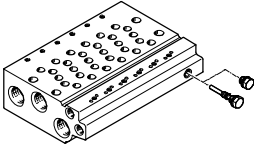
Technical data – Manifold rails ¹⁾									
	Port			CRC	Material ³⁾	Operating pressure [bar]	Max. tightening torque for assembly [Nm]		
	2, 4	1, 3, 5	12/14, 82/84				Valve	H-rail	Wall
	G1/4	G3/8	M5	2 ²⁾	Wrought aluminium alloy	-0.9 ... 10	1.18	1.5	3

- 1) Blanking plugs are included with the manifold rail.
- 2) Corrosion resistance class CRC 2 to Festo standard FN 940070
Moderate corrosion stress. Indoor applications in which condensation may occur. External visible parts with primarily decorative requirements for the surface and which are in direct contact with the ambient atmosphere typical for industrial applications.
- 3) Note on materials: RoHS-compliant.

Order code – Manifold rails

VABM	-	L1	-	18	W	-	G38	-	
Valve manifold parts									Number of valve positions
Manifold rail		VABM							2 to 10, 12, 14 and 16
Valve series									Ports 1, 3, 5
VUVG		L1					G38		G3/8 thread
Valve size									
18 mm					18				
Manifold rail with ports 1, 2, 3, 4, 5, 12/14, 82/84									
Port 2 and 4 with G1/4 thread									
					W				



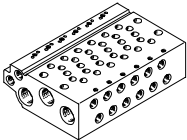

Ordering data – Manifold rails

Description	Part No.	Type	
Manifold rail for sub-base valve G1/4			
	For size B18 (G1/4)		
	2 valve positions	574467	VABM-L1-18W-G38-2
	3 valve positions	574468	VABM-L1-18W-G38-3
	4 valve positions	574469	VABM-L1-18W-G38-4
	5 valve positions	574470	VABM-L1-18W-G38-5
	6 valve positions	574471	VABM-L1-18W-G38-6
	7 valve positions	574472	VABM-L1-18W-G38-7
	8 valve positions	574473	VABM-L1-18W-G38-8
	9 valve positions	574474	VABM-L1-18W-G38-9
	10 valve positions	574475	VABM-L1-18W-G38-10
12 valve positions	574476	VABM-L1-18W-G38-12	
14 valve positions	574477	VABM-L1-18W-G38-14	
16 valve positions	574478	VABM-L1-18W-G38-16	

Solenoid valves VUVG-B18, sub-base valves G1/4

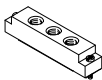

Ordering data

Ordering data – Accessories			
	Description	Part No.	Type
Blanking plate Technical data → Internet: vabb			
	For valve position on manifold rail, including screws and seal	★ 574482	VABB-L1-18
Separator Technical data → Internet: vabd			
	For creating pressure zones	574483	VABD-14-B
Supply plate Technical data → Internet: vabf			
	For valve position on manifold rail, including screws and seal	574481	VABF-L1-18-P3A4-G14
Seals Technical data → Internet: vabd			
	For sub-base valves G1/4	Delivery unit: 10 sets (each with 2 screws and 1 seal)	574480 VABD-L1-18B-S-G14

 Note
 Connect supply plate at port 1 with compressed air. Reverse operation (pressure at port 3, 5) is not permissible.

Festo core product range ★ Ready for dispatch from the Festo factory in 24 hours
☆ Ready for dispatch in 5 days maximum from stock

Solenoid valves VUVG

Electrical connection boxes



General technical data							
Variants	H2	H3	S2	S3	L-	R1	R8
Mounting position	Any						
Electrical connection	2-pin, socket				Flying leads	Individual plug connector M8, 4-pin	Individual plug connector M8, 3-pin
Degree of protection	IP40					IP65	
Switching position display	LED						
Type of mounting	Clip					Self-tapping screw	
Note on materials	RoHS compliant						
Housing colour	Black						
Information on housing materials	PA						
Certification	RCM						

Protective circuit Without holding current reduction

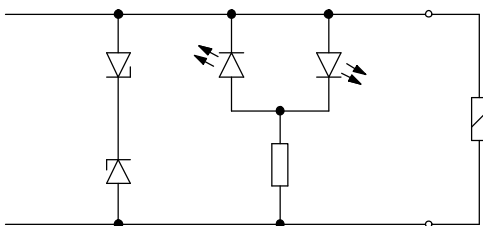

The solenoid coils (P type) of the 5, 12 and 24 V designs are equipped with a protective circuit to arrest sparks and protect against polarity reversal.

Protective circuit with holding current reduction

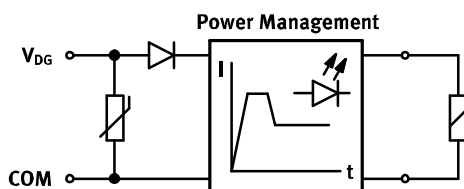

The 24 V DC design (R type) additionally features holding current reduction. This reduces the power from 1 W to 0.35 W.



Pin allocation for electrical connection box

	Pin	Description
Rectangular plug connector, connection pattern H		
	VAVE-L1-1VH2-LP, VAVE-L1-1VH3-LP	
	1	+ or -
	2	+ or -
	VAVE-L1-1H2-LR, VAVE-L1-1H3-LR	
	1	+
	2	-
Rectangular plug connector, connection pattern S		
	VAVE-L1-1VS2-LP, VAVE-L1-1VS3-LP	
	1	+ or -
	2	+ or -
	VAVE-L1-1S2-LR, VAVE-L1-1S3-LR	
	1	-
	2	+
Flying leads, 2-pin		
	VAVE-L1-1VL1...4-LP	
	1	+ or -
	2	+ or -
	VAVE-L1-1L1...4-LR	
	1	-
	2	+

Solenoid valves VUVG

Electrical connection boxes

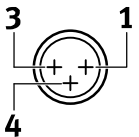
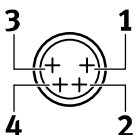
FESTO

Pin allocation for electrical connection box			
	Pin	Description	
Round plug connector, M8, 3-pin			
	VAVE-L1-1VR8-LP		
	1	Not used	Without holding current reduction
	3	+ or -	
	4	+ or -	
	VAVE-L1-1R8-LR		With holding current reduction
	1	Not used	
3	+ or -		
4	+ or -		
Round plug connector, M8, 4-pin			
	VAVE-L1-1VR1-LP		
	1	Not used	Without holding current reduction
	2	Not used	
	3	+ or -	
	4	+ or -	
	VAVE-L1-1R1-LR		With holding current reduction
	1	Not used	
	2	Not used	
3	+ or -		
4	+ or -		
Open cable end			
	VAVE-L1-1VK...		
	BK	+ or -	Without holding current reduction
	BK	+ or -	
	VAVE-L1-1K...		With holding current reduction
	BK	+ or -	
	BK	+ or -	

Solenoid valves VUVG

Electrical connection boxes

FESTO

Dimensions

Download CAD data → www.festo.com

Electrical connection boxes, S2/H2

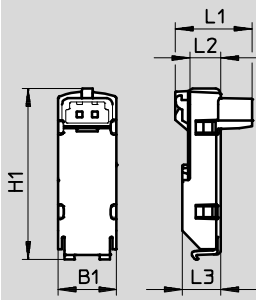

Type	B1	H1 ±0.5	L1	L2	L3
VAVE-L1-1VS2-LP	9.8	28.8	12.9	5.2	6.5
VAVE-L1-1S2-LR			10.8		
VAVE-L1-1VH2-LP					
VAVE-L1-H2-LR					

Electrical connection boxes, S3/H3

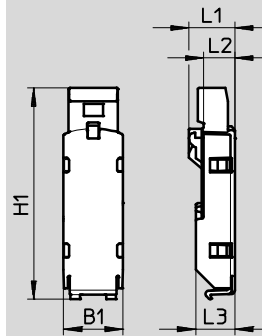

Type	B1	H1 ±0.5	L1	L2	L3
VAVE-L1-1VS3-LP	9.8	35	7.6	5.2	6.5
VAVE-L1-1S3-LR					
VAVE-L1-1VH3-LP		33.6	7.5		
VAVE-L1-1H3-LR					

Dimensions

Download CAD data → www.festo.com

Electrical connection boxes, VL11 ...1 4

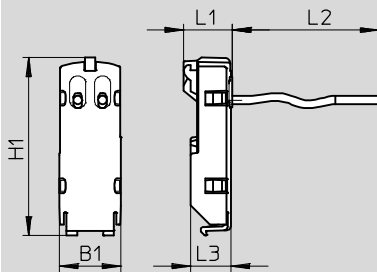

Type	B1	H1 ±0.5	L1	L2	L3
VAVE-L1-1VL1-LP	9.8	28.8	7.9	0.5	6.5
VAVE-L1-1L1-LR				1	
VAVE-L1-1VL2-LP					
VAVE-L1-1L2-LR					
VAVE-L1-1VL3-LP				2.5	
VAVE-L1-1L3-LR					
VAVE-L1-1VL4-LP				5	
VAVE-L1-1L4-LR					

Electrical connection boxes, VK6 ... 9

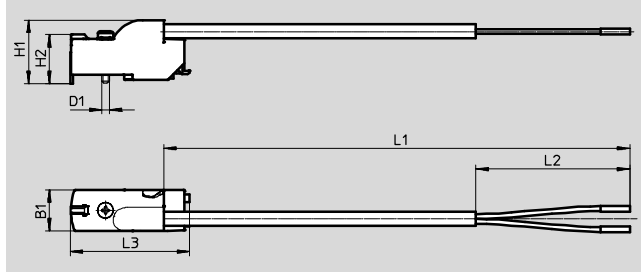

Type	B1	H1	H2 ±0.3	L1	L2 ±5	L3 ±0.5	D1 ∅
VAVE-L1-1VK6-LP	9.8	15.3	11.8	0.5	50	28.7	1.8
VAVE-L1-1VK7-LP				1.0			
VAVE-L1-1VK8-LP				2.5			
VAVE-L1-1VK9-LP				5.0			
VAVE-L1-1K6-LR				0.5			
VAVE-L1-1K7-LR				1.0			
VAVE-L1-1K8-LR				2.5			
VAVE-L1-1K9-LR				5.0			

Solenoid valves VUVG

Electrical connection boxes

FESTO

Dimensions

Download CAD data → www.festo.com

Electrical connection boxes, R8/R1

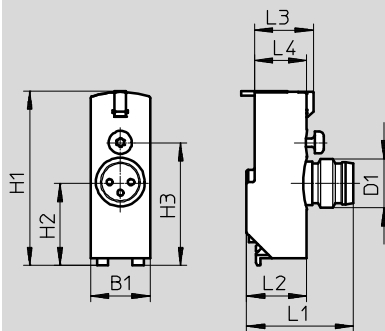

Type	B1	H1	H2	H3	L1	L2	L3	L4	D1
VAVE-L1-1VR8-LP	9.8	28.7	13.7	20.2	18.4	9.9	9.7	8.6	M8
VAVE-L1-1VR1-LP									

Ordering data – Electrical connection boxes

Design	Plug connector	Additional functions	Ambient temperature [°C]	Code	Power	Voltage	Part No.	Type
					[W]	[V DC]		
	NEBV-H1 ...	Spark arresting, bipolar, IP40	-5 ... +50	H2	1	12/24	★ 566714	VAVE-L1-1VH2-LP
		Spark arresting, holding current reduction, IP40	-5 ... +60	H2R	0.35	24	★ 566716	VAVE-L1-1H2-LR
	NEBV-H1 ...	Spark arresting, bipolar, IP40	-5 ... +50	H3	1	12/24	566715	VAVE-L1-1VH3-LP
		Spark arresting, holding current reduction, IP40	-5 ... +60	H3R	0.35	24	566717	VAVE-L1-1H3-LR
	NEBV-HS ...	Spark arresting, bipolar, IP40	-5 ... +50	S2	1	12/24	566718	VAVE-L1-1VS2-LP
		Spark arresting, holding current reduction, IP40	-5 ... +60	S2R	0.35	24	566720	VAVE-L1-1S2-LR
	NEBV-HS ...	Spark arresting, bipolar, IP40	-5 ... +50	S3	1	12/24	566719	VAVE-L1-1VS3-LP
		Spark arresting, holding current reduction, IP40	-5 ... +60	S3R	0.35	24	566721	VAVE-L1-1S3-LR
	Open cable end	Spark arresting, bipolar, IP40	-5 ... +50	L1	1	12/24	566722	VAVE-L1-1VL1-LP
				L2			566723	VAVE-L1-1VL2-LP
				L3			566724	VAVE-L1-1VL3-LP
				L4			566725	VAVE-L1-1VL4-LP
		Spark arresting, holding current reduction, IP40	-5 ... +60	L1R	0.35	24	566726	VAVE-L1-1L1-LR
				L2R			566727	VAVE-L1-1L2-LR
				L3R			566728	VAVE-L1-1L3-LR
				L4R			566729	VAVE-L1-1L4-LR

Festo core product range

★ Ready for dispatch from the Festo factory in 24 hours

☆ Ready for dispatch in 5 days maximum from stock

Solenoid valves VUVG

Electrical connection boxes

FESTO

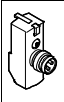
Ordering data – Electrical connection boxes									
Design	Plug connector	Additional functions	Ambient temperature [°C]	Code	Power	Voltage	Cable length	Part No.	Type
					[W]	[V DC]	[m]		
	Open cable end	Spark arresting, bipolar, IP65	-5 ... +60	K6	1	12/24	0.5	573941	VAVE-L1-1VK6-LP
				K7			1	★ 573942	VAVE-L1-1VK7-LP
				K8			2.5	573943	VAVE-L1-1VK8-LP
				K9			5	573944	VAVE-L1-1VK9-LP
		Spark arresting, bipolar, holding current reduction, IP65	-5 ... +60	K6R	0.35	24	0.5	573945	VAVE-L1-1K6-LR
				K7R			1	573946	VAVE-L1-1K7-LR
				K8R			2.5	573947	VAVE-L1-1K8-LR
				K9R			5	573948	VAVE-L1-1K9-LR
	NEBU-M8 ...	Spark arresting, bipolar, IP65	-5 ... +60	R8	1	12/24	-	★ 573919	VAVE-L1-1VR8-LP
		Spark arresting, bipolar, holding current reduction, IP65		R8R				0.35	24
		Spark arresting, bipolar, IP65		R1	1	12/24	-	573921	VAVE-L1-1VR1-LP
		Spark arresting, bipolar, holding current reduction, IP65		R1R					

Festo core product range



★ Ready for dispatch from the Festo factory in 24 hours

☆ Ready for dispatch in 5 days maximum from stock

Solenoid valves VUVG

Accessories

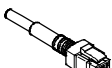
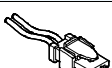
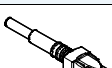
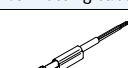
FESTO

Ordering data				
	Description	Cable length [m]	Part No.	Type
Plug socket with cable, not sheathed, open end Technical data → Internet: nebv				
	For electrical connection box code H2, H2R or H3, H3R, 2-pin socket	0.5	★ 566654	NEBV-H1G2-KN-0.5-N-LE2
		1	★ 566655	NEBV-H1G2-KN-1-N-LE2
		2.5	★ 566656	NEBV-H1G2-KN-2.5-N-LE2
		5	566657	NEBV-H1G2-KN-5-N-LE2
Plug socket with cable, sheathed, open end Technical data → Internet: nebv				
	For electrical connection box code H2, H2R or H3, H3R, 2-pin socket	0.5	★ 566658	NEBV-H1G2-P-0.5-N-LE2
		1	★ 566659	NEBV-H1G2-P-1-N-LE2
		2.5	★ 566660	NEBV-H1G2-P-2.5-N-LE2
		5	566661	NEBV-H1G2-P-5-N-LE2
Plug socket with cable, not sheathed, open end Technical data → Internet: nebv				
	For electrical connection box code S2, S2R or S3, S3R, 2-pin socket	0.5	566662	NEBV-HSG2-KN-0.5-N-LE2
		1	566663	NEBV-HSG2-KN-1-N-LE2
		2.5	566664	NEBV-HSG2-KN-2.5-N-LE2
		5	566665	NEBV-HSG2-KN-5-N-LE2
Plug socket with cable, sheathed, open end Technical data → Internet: nebv				
	For electrical connection box code S2, S2R or S3, S3R, 2-pin socket	0.5	566666	NEBV-HSG2-P-0.5-N-LE2
		1	566667	NEBV-HSG2-P-1-N-LE2
		2.5	566668	NEBV-HSG2-P-2.5-N-LE2
		5	566669	NEBV-HSG2-P-5-LE2
Connecting cable, open end Technical data → Internet: nebu				
	For electrical connection box code R8 3-pin, straight socket, M8x1	2.5	★ 541333	NEBU-M8G3-K-2.5-LE3
		5	★ 541334	NEBU-M8G3-K-5-LE3
	For electrical connection box code R1 4-pin, straight socket, M8x1	2.5	541342	NEBU-M8G4-K-2.5-LE4
		5	541343	NEBU-M8G4-K-5-LE4
Connecting cable, open end Technical data → Internet: nebu				
	For electrical connection box code R8 3-pin, angled socket, M8x1	2.5	★ 541338	NEBU-M8W3-K-2.5-LE3
		5	★ 541341	NEBU-M8W3-K-5-LE3
	For electrical connection box code R1 4-pin, angled socket, M8x1	2.5	541344	NEBU-M8W4-K-2.5-LE4
		5	541345	NEBU-M8W4-K-5-LE4
Connecting cable Technical data → Internet: nebu				
	For electrical connection box code R8, 3-pin, straight socket, M8x1	0.5	★ 541346	NEBU-M8G3-K-0.5-M8G3
		1	★ 541347	NEBU-M8G3-K-1-M8G3
		2.5	★ 541348	NEBU-M8G3-K-2.5-M8G3
		5	★ 541349	NEBU-M8G3-K-5-M8G3
		10	569844	NEBU-M8G3-K-10-M8G3
	For electrical connection box code R1, 4-pin, straight socket, M8x1	2.5	554035	NEBU-M8G4-K-2.5-M8G4







Festo core product range

- ★ Ready for dispatch from the Festo factory in 24 hours
- ☆ Ready for dispatch in 5 days maximum from stock

Solenoid valves VUVG

Accessories

FESTO

Ordering data							
Description			Part No.	Type	PU ¹⁾		
Blanking plug Technical data → Internet: b							
	For manifold rail and valve	M5 thread	★ 3843	B-M5	10		
		M7 thread	★ 174309	B-M7	10		
	For manifold rail	G1/8 thread	★ 3568	B-1/8	10		
		G1/4 thread	★ 3569	B-1/4	10		
		G3/8 thread	★ 3570	B-3/8	10		
	For valve	G1/8 thread	578406	NPQH-BK-G18-P10	10		
		G1/4 thread	578407	NPQH-BK-G14-P10	10		
Reducing nipple							
	Male thread M7	Female thread M5	161359	D-M5I-M7A-ISK	10		
Fittings Technical data → Internet: qsm							
	M3 thread	For tubing Ø 3 mm	Round releasing ring	133001	QSM-M3-3-I-R	10	
		For tubing Ø 4 mm	Round releasing ring	133002	QSM-M3-4-I-R	10	
	M5 thread	For tubing Ø 3 mm	Round releasing ring	133003	QSM-M5-3-I-R	10	
			Oval releasing ring	★ 153313	QSM-M5-3-I	10	
		For tubing Ø 4 mm	Round releasing ring	133004	QSM-M5-4-I-R	10	
			Oval releasing ring	★ 153315	QSM-M5-4-I	10	
	For tubing Ø 6 mm	Round releasing ring	133005	QSM-M5-6-I-R	10		
		Oval releasing ring	★ 153317	QSM-M5-6-I	10		
	M7 thread	For tubing Ø 4 mm	Oval releasing ring	★ 153319	QSM-M7-4-I	10	
		For tubing Ø 6 mm	Round releasing ring	133007	QSM-M7-6-I-R	10	
			Oval releasing ring	★ 153321	QSM-M7-6-I	10	
	G1/8 thread	For tubing Ø 4 mm	Oval releasing ring	★ 186106	QS-G1/8-4-I	10	
		For tubing Ø 6 mm	Oval releasing ring	★ 186107	QS-G1/8-6-I	10	
		For tubing Ø 8 mm	Oval releasing ring	★ 186109	QS-G1/8-8-I	10	
		For tubing Ø 10 mm	Oval releasing ring	★ 132999	QS-G1/8-10-I	10	
	G1/4 thread	For tubing Ø 6 mm	Oval releasing ring	★ 186108	QS-G1/4-6-I	10	
				130677	QS-1/4-6-100	100	
		For tubing Ø 8 mm	Oval releasing ring	★ 186110	QS-G1/4-8-I	10	
				★ 153016	QS-1/4-8-I	10	
		For tubing Ø 10 mm	Oval releasing ring	★ 186112	QS-G1/4-10-I	10	
				★ 153018	QS-1/4-10-I	10	
	3/8 thread	For tubing Ø 8 mm	Oval releasing ring	130681	QS-3/8-8-50	50	
		For tubing Ø 10 mm	Oval releasing ring	130682	QS-3/8-10-50	50	
		For tubing Ø 12 mm	Oval releasing ring	130683	QS-3/8-12-20	20	
		For tubing Ø 16 mm	Oval releasing ring	★ 164957	QS-3/8-16	1	
	Silencer Technical data → Internet: amte						
		For M3 thread			1231120	AMTE-M-LH-M3	20
For M5 thread				★ 1205858	AMTE-M-LH-M5	20	
	For M7 thread			161418	UC-M7	1	
	For G1/8 thread	High flow rate		★ 2307	U-1/8	1	
		Lower flow rate		161419	UC-1/8	1	
	For G1/4 thread	High flow rate		★ 2316	U-1/4	1	
		Lower flow rate		165004	UC-1/4	1	
	For G3/8 thread	High flow rate		★ 2309	U-3/8	1	
		Lower flow rate		1707427	UC-3/8	1	
		Metal housing		★ 6843	U-3/8-B	1	

1) Packaging unit.







Festo core product range

- ★ Ready for dispatch from the Festo factory in 24 hours
- ☆ Ready for dispatch in 5 days maximum from stock

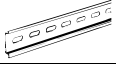
Solenoid valves VUVG

Accessories

FESTO

Ordering data				
	Description	Part No.	Type	PU ¹⁾
H-rail Technical data → Internet: nrh				
	To EN 60715, 35 x 7.5 (WxH) Length: 2 m	35430	NRH-35-2000	1
H-rail mounting Technical data → Internet: vame				
	-	★ 569998	VAME-T-M4	2
Cover cap for manual override				
	Covered	540898	VMPA-HBV-B	10
	Non-detenting	540897	VMPA-HBT-B	10
	Detenting (without accessories)	8002234	VAMC-L1-CD	10
Inscription label holder Technical data → Internet: aslr				
	Holder for an inscription label and covering the mounting screw and manual override	570818	ASLR-D-L1	10





Festo core product range

- ★ Ready for dispatch from the Festo factory in 24 hours
- ☆ Ready for dispatch in 5 days maximum from stock

Solenoid valves VUVG

Accessories

FESTO

Ordering data						
	Description		Part No.	Type	PU ¹⁾	
Check valve						
	For manifold rails VABM-L1-10...	For blocking the flow in the event of back pressure in duct 3 and 5	8047364	VABF-L1-10H-H2	10	
	For manifold rails VABM-L1-14...	For blocking the flow in the event of back pressure in duct 3 and 5	8047365	VABF-L1-14-H2	10	
Flow restrictor						
	For manifold rails VABM-L1-10...	For setting the flow rate during pressurisation and exhausting (for threaded connection M5)	Nominal size: 0.5 mm	8025709	VFFG-T-M5-5	10
			Nominal size: 0.6 mm	8025710	VFFG-T-M5-6	10
			Nominal size: 0.7 mm	8025711	VFFG-T-M5-7	10
			Nominal size: 0.85 mm	8025712	VFFG-T-M5-8	10
			Nominal size: 1.05 mm	8025713	VFFG-T-M5-10	10
			Nominal size: 1.2 mm	8025714	VFFG-T-M5-12	10
			Nominal size: 1.55 mm	8025715	VFFG-T-M5-15	10
		For setting the flow rate during pressurisation and exhausting (for Ø 4 mm)	Nominal size: 0.5 mm	8047346	VFFG-T-F4-5	10
			Nominal size: 0.6 mm	8047347	VFFG-T-F4-6	10
			Nominal size: 0.7 mm	8047348	VFFG-T-F4-7	10
			Nominal size: 0.85 mm	8047349	VFFG-T-F4-8	10
			Nominal size: 1.05 mm	8047350	VFFG-T-F4-10	10
			Nominal size: 1.2 mm	8047351	VFFG-T-F4-12	10
			Nominal size: 1.55 mm	8047352	VFFG-T-F4-15	10
For manifold rails VABM-L1-14...		For setting the flow rate during pressurisation and exhausting (for Ø 5.8 mm)	Nominal size: 0.7 mm	8047353	VFFG-T-F6-7	10
			Nominal size: 0.85 mm	8047354	VFFG-T-F6-8	10
			Nominal size: 1.05 mm	8047355	VFFG-T-F6-10	10
			Nominal size: 1.15 mm	8047356	VFFG-T-F6-11	10
			Nominal size: 1.4 mm	8047357	VFFG-T-F6-14	10
			Nominal size: 1.6 mm	8047358	VFFG-T-F6-16	10
Nominal size: 1.8 mm	8047359	VFFG-T-F6-18	10			
Restrictor set						
	For manifold rails VABM-L1-10...	Two of each size, for threaded connection M5	8025716	VFFG-T-M5-A-V1	14	
		Two of each size, for Ø 4 mm	8062200	VFFG-T-F4-A-V1	14	
	For manifold rails VABM-L1-14...	Two of each size, for Ø 5.8 mm	8062201	VFFG-T-F6-A-V1	14	

1) Packaging unit.

Valve terminals VTUG with multi-pin plug and fieldbus connection

Key features

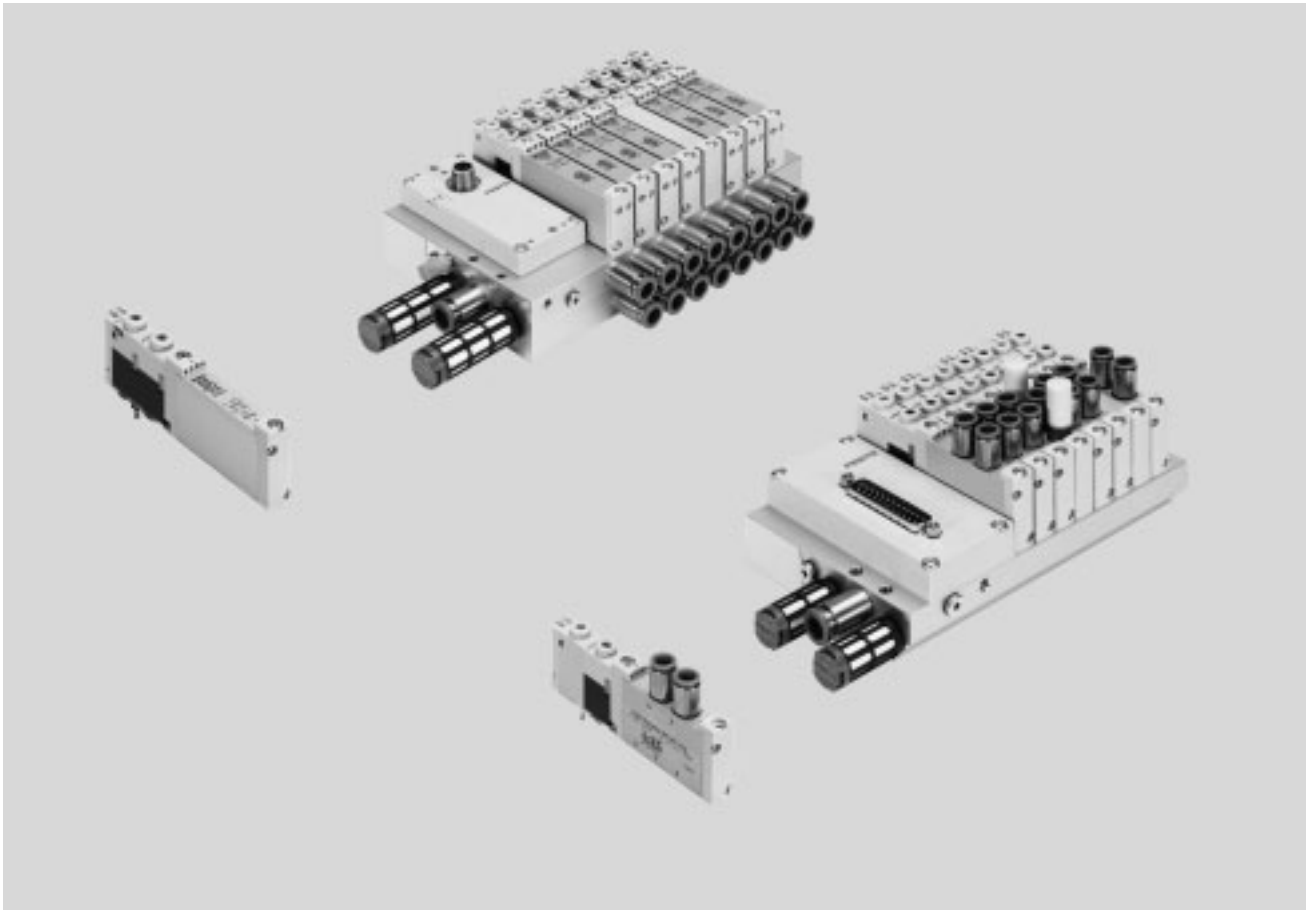

Innovative

- Festo-specific I-Port interface for bus nodes (CTEU)
- IO-Link mode for direct connection to a higher-level IO-Link master
- Festo-specific I-Port interface with interlock
- Variable multi-pin plug connection using Sub-D or flat cable
- Reversible piston spool valves, up to 24 valve positions
- Reduced power consumption
- Excellent price/performance ratio

Versatile

- Choice of quick push-in connectors
- Multiple pressure zones possible
- Sub-D variant and fieldbus connection rated to IP67
- Internal or external pilot air with the same manifold rail possible through the use of blanking plugs
- Sub-base valves with working ports underneath for installation in control cabinets

Reliable

- Sturdy and durable metal components
 - Valves
 - Manifold rails
- Fast troubleshooting thanks to LED display
- Manual override: choose from non-detenting, detenting or covered

Easy to install

- Easy mounting thanks to captive screws and seal
- Connection technology easy to change
- Inscription label holder for labelling

Valve terminal configurator

A valve terminal configurator is available to help you select a suitable valve terminal VTUG. This makes it much easier to order the right product.

Valve terminals VTUG are ordered via an ident. code. All valve terminals are supplied fully assembled and individually tested.

This reduces assembly and installation time to a minimum.

Download CAD data → www.festo.com

Ordering system for valve terminal VTUG
→ Internet: vtug

Valve terminals VTUG with multi-pin plug and fieldbus connection

Key features

Sub-base and semi in-line valves for valve terminal VTUG

VUVG-S...1T1, semi in-line valve

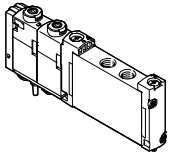

In the case of semi in-line valves, the supply ports (1, 3 and 5) are connected to the valve by means of pneumatic linking (e.g. sub-base). The working ports (2, 4) are on the valve.

Valve terminal VTUG with variable electrical connection

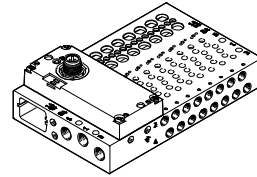

VUVG-B...1T1, sub-base valve

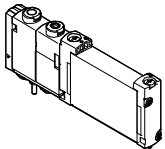

In the case of sub-base valves, the supply ports (1, 3 and 5) and the working ports (2, 4) are connected to the valve by means of pneumatic linking (e.g. sub-base).

Overview – Valve terminal with multi-pin plug and fieldbus connection

Variable electrical connection:
flat cable or Sub-D

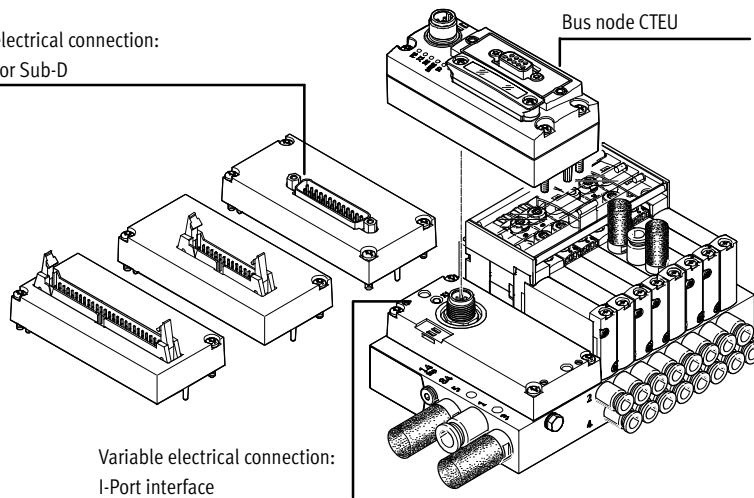

Overview – Valve terminal with interlock

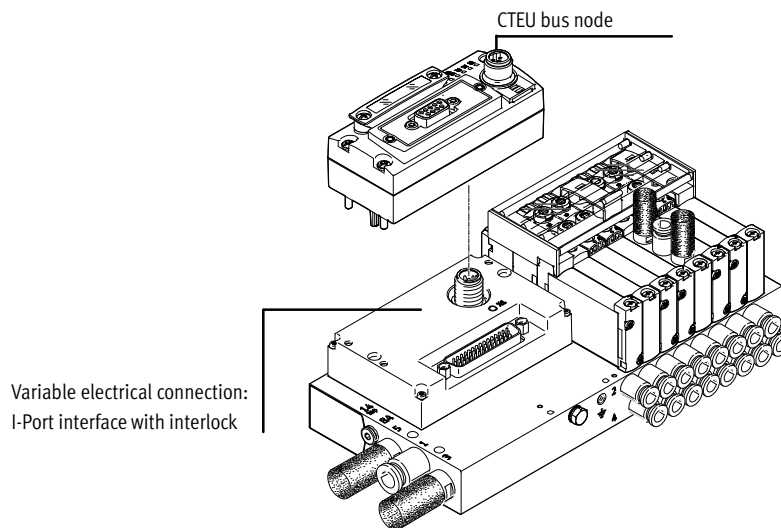

Valve terminals VTUG with multi-pin plug and fieldbus connection

Key features

Equipment options		
Valve functions		Electrical connection options
<ul style="list-style-type: none"> • 2x 3/2-way, 3/2-way, 5/2-way, 5/3-way valves 	<ul style="list-style-type: none"> • Reversible piston spool valves, up to 24 valve positions 	<ul style="list-style-type: none"> • IO-Link mode for direct connection to a higher-level IO-Link master • Festo-specific I-Port interface for bus nodes (CTEU) • Variable multi-pin plug connection using Sub-D or flat cable • Festo-specific I-Port interface with interlock (for valves of valve size 10 mm)

Basic valves VUVG	
Valve size	Variants
<ul style="list-style-type: none"> • 10 mm • 14 mm • 18 mm 	<ul style="list-style-type: none"> • Semi in-line valve • Sub-base valve

Valve functions			
3/2-way valve	2x 3/2-way valve	5/2-way valve	5/3-way valve
<ul style="list-style-type: none"> • Single solenoid • Normally open • Normally closed 	<ul style="list-style-type: none"> • Single solenoid • Normally open • Normally closed • 1x normally closed, 1x normally open • Mechanical spring • Pneumatic spring 	<ul style="list-style-type: none"> • Single solenoid • Pneumatic/mechanical spring • Mechanical spring • Pneumatic spring • Double solenoid valve 	<ul style="list-style-type: none"> • Mid-position pressurised • Mid-position exhausted • Mid-position closed

Cover caps for manual override

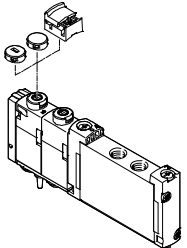

- Closed cover cap, covered manual override
- Slotted cover cap, non-detenting manual override
- Cover cap for detenting actuation without tools

Inscription label holder

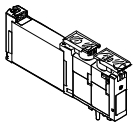

Inscription label holder ASLR-D-L1 for identifying the valves and as a cover for the manual override.

Inscription label holder

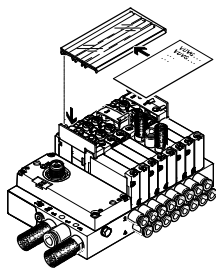

Inscription label holder ASCF-H-L1... for identifying the valves on the valve terminal VTUG.

Valve terminals VTUG with multi-pin plug and fieldbus connection

Key features – Pneumatics

Manifold rail

For semi in-line valves

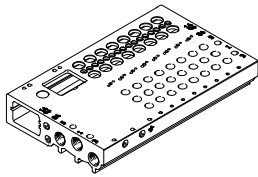

The semi in-line valves are supplied with external pilot air. The pilot air is set via the manifold rail. The manifold rail is delivered with a short and a long blanking plug for setting the pilot air.

- For semi in-line valves, M5/M7 (valve size 10 mm), G1/8 (valve size 14 mm) and G1/4 (valve size 18 mm)

- For 2x 3/2-way, 5/2-way and 5/3-way valves
- 4 to 24 valve positions with electrical interlinking

For sub-base valves

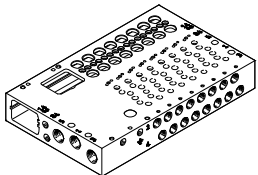

The sub-base valves are supplied with external pilot air. The pilot air is set via the manifold rail. The manifold rail is delivered with a short and a long blanking plug for setting the pilot air.

- For sub-base valves M5/M7 (valve size 10 mm), G1/8 (valve size 14 mm) and G1/4 (valve size 18 mm)

- For 2x 3/2-way, 3/2-way, 5/2-way and 5/3-way valves
- 4 to 24 valve positions with electrical interlinking

Long version

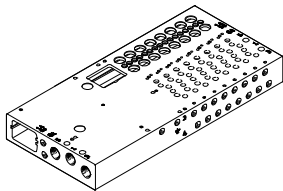

Versions:

- I-Port interface on the side: for semi in-line valves and sub-base valves, M5/M7 (valve size 10 mm), G1/8 (valve size 14 mm) and G1/4 (valve size 18 mm)

- Interlock: For sub-base and semi in-line valves M5/M7 (valve size 10 mm)

For control cabinet installation, outlet direction underneath

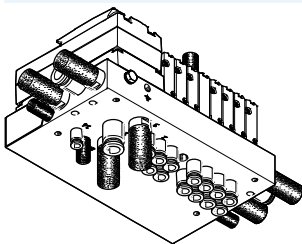

For sub-base valves M5/M7 (valve size 10 mm)

For control cabinet installation, outlet direction to the front

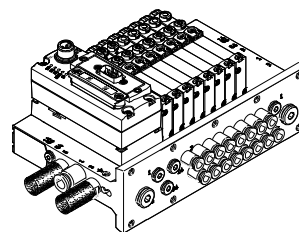

For sub-base valves M7 (valve size 10 mm) and G1/8 (valve size 14 mm)

 Note
Pressurisation and exhaust at both ends is recommended for an optimised flow rate in cases where multiple valves switch simultaneously.

Valve terminals VTUG with multi-pin plug and fieldbus connection

Key features

Electrical connection

Multi-pin plug connection

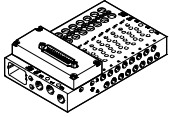

The signals are transmitted from the controller to the valve terminal via a pre-assembled or self-assembled multi-wire cable to the multi-pin plug connection.

This substantially reduces installation time compared to individually connected valves. The valve terminal can be equipped with max. 48 solenoid coils.

Versions:

- Sub-D connection
- Flat cable

I-Port interface

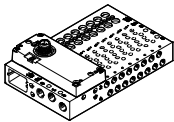

Festo-specific interface as a basis for bus nodes (CTEU) or in IO-Link mode for direct connection to a higher-level IO-Link master.

Communication and power supply take place via a common M12 interface.

Connection options:

- As I-Port interface for bus nodes (CTEU)
- In IO-Link mode for direct connection to an IO-Link master

I-Port interface with interlock

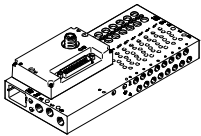

The interlock function enables the first 16 solenoid coils to be individually supplied externally.

The external supply guarantees safety-related release of these valves.

-  - Note

The VTUG variant with multi-pin plug and fieldbus connection offers the additional option of individual

electrical actuation of the valves (see → page 134).

Supply plate

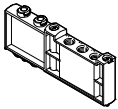

For additional air supply and exhaust via a valve position

-  - Note

The supply plate VABF-L1-14-P3A4-G18-T1 can only be used with G fittings. R fittings are not permissible.

Blanking plate for unused valve position

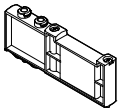

Vacant position cover

Separator for pressure zones



For creating multiple pressure zones in a valve terminal

Valve terminals VTUG with multi-pin plug and fieldbus connection

Key features – Pneumatics

Creating pressure zones and separating exhaust air

Compressed air is supplied and exhausted via the manifold rail and via supply plates.

The position of the supply plates and duct separations can be freely selected with the VTUG.



A pressure zone is created by separating the internal supply ducts using a separator.

Pressure zone separation can be used for the following ducts:

- Duct 1
- Duct 3
- Duct 5

 Note

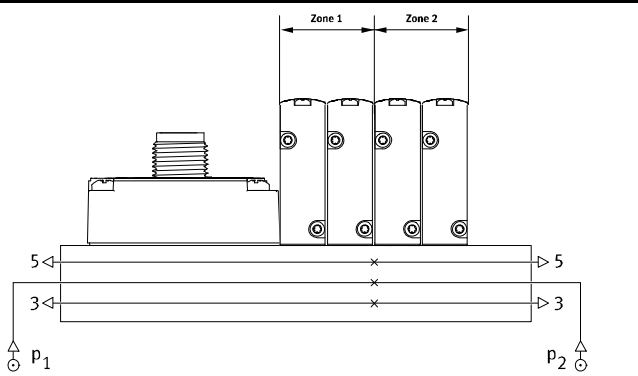
- Use a separator if the exhaust air pressures are high
- Use at least one supply plate/ supply for each pressure zone
- Pressure zone separation is not possible in duct 12/14 (pilot air supply)

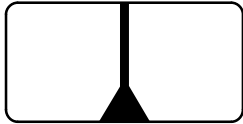
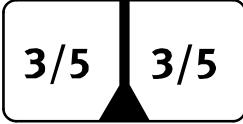
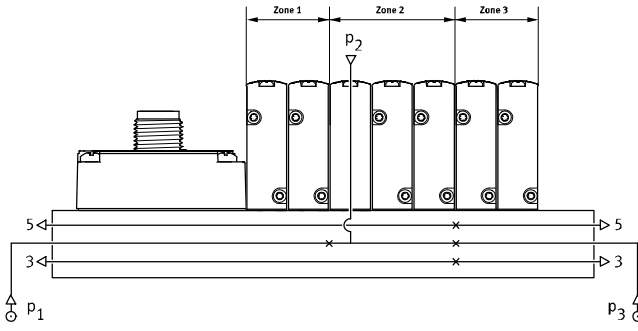
Duct separation	Description
	<p>The pressure zones can be freely configured with the VTUG. The following duct separations are possible:</p> <p>Duct 1 closed </p> <p>Duct 1, 3, 5 closed </p> <p>Duct 3, 5 closed </p>
	<p>The number of pressure zones with the VTUG is limited by the number of valve positions on the manifold rail. Note that each supply plate occupies one valve position.</p>

Separator VABD

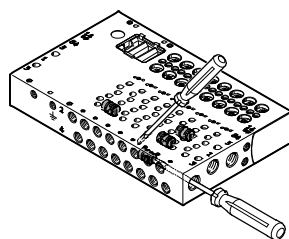

1 Separator VABD

 Note

With the VTUG, several pressure zones can be created by fitting separators (VABD). The separators are inserted in the manifold rail using a slotted screwdriver.

Valve terminals VTUG with multi-pin plug and fieldbus connection

Key features – Pneumatics

Pilot air supply		External pilot air supply	Pilot exhaust air
Internal pilot air supply	Internal pilot air supply can be chosen with an operating pressure in the range 1.5 ... 8 bar, 2.5 ... 8 bar or 3 ... 8 bar (depending on the valve used).	External pilot air supply is required for vacuum operation and operating pressures above 8 bar. The port for external pilot air supply (port 12/14) is located on the manifold rail.	The pilot air is exhausted via duct 82/84 of the manifold rail.

Pilot air supply

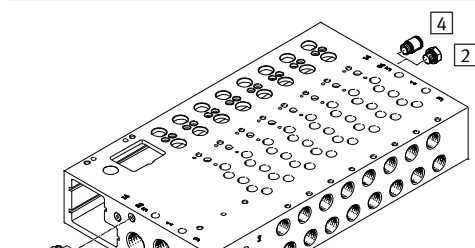

The diagram shows a perspective view of a valve manifold rail with various ports. Four specific configurations are highlighted with numbered callouts:

- 1 Blanking plug, short, with internal pilot air
- 2 Blanking plug for duct 12/14 with internal pilot air
- 3 Blanking plug, long, with external pilot air
- 4 Push-in fitting in duct 12/14 with external pilot air

The manifold rails have an internal conduit between duct 12/14 and duct 1. Internal or external pilot air supply is selected by inserting a blanking plug into this conduit.

Valve terminals VTUG with multi-pin plug and fieldbus connection

Key features – Pneumatics

Exhaust functions

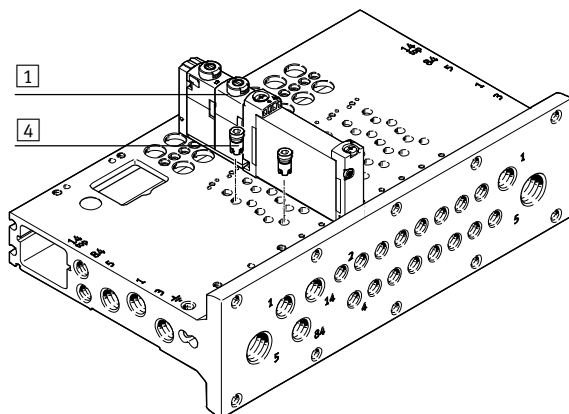
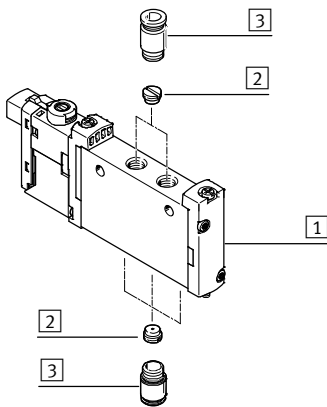

- 1 Valves VUVG
- 2 Flow restrictor for thread M5
- 3 Fitting
- 4 Fixed flow restrictor, self-tapping/check valve

Flow restrictor for thread M5

Semi in-line valve, individual electrical connection: flow restrictor can be fitted in port 1, 3, 5 and/or in port 2, 4.

Sub-base valve, individual electrical connection: flow restrictor can be fitted in port 2, 4.

Fixed flow restrictor, self-tapping

The fixed restrictor can be used to permanently set the exhaust flow rate in ducts 3 and 5.

The fixed restrictors are screwed into ducts 3 and 5 in the manifold rail.

Please see the relevant assembly instructions:

→ www.festo.com/sp

Check valve

Check valves block the flow towards the valves if back pressure develops in ducts 3 and 5 in the case of a high exhaust capacity and thus prevents actuators from switching unexpectedly.

The check valves are screwed into ducts 3 and 5 in the manifold rail. Please see the relevant assembly instructions:

→ www.festo.com/sp

 Note

- It is not possible to use a check valve and a fixed restrictor (in the same duct) at the same time.
- When screwing in again, use the threads already present.

Valve terminals VTUG with multi-pin plug and fieldbus connection

Key features – Pneumatics

Operation with different pressures

Vacuum operation

Points to note with 3/2-way valves with pneumatic spring return:

The 3/2-way valves are available in a design with two valves in one valve body and with pneumatic spring return. With these valves, the force for the return movement is supplied through port 1.

Vacuum operation is only possible at port 3 and 5, not at port 1.

With external pilot air supply, vacuum can be connected at port 1, 3, 5 of the 5/2-way and 5/3-way valves.

Reverse operation

The 3/2-way valves with pneumatic spring are not suitable for reverse operation, since at least the minimum pilot pressure must be present in duct 1.



Note

Pressure must be present at port 1.

Pressure deflector (internal pilot air)

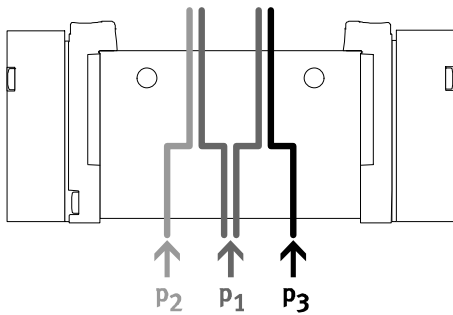

- Two different pressures are required.
- Different pressures can be connected at duct 1, 3 and 5.

Benefits

Any pressure or vacuum can be connected at duct 3 and 5 both with external and internal pilot air



Note

- With internal pilot air, adhere to the minimum pilot pressure in duct 1

- With 2x 3/2-way valves without spring return, adhere to minimum pilot pressure in duct 1

Vacuum, ejector pulse and normal position

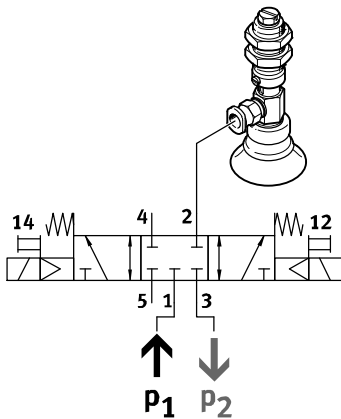

Vacuum, ejector pulse and normal position with internal pilot air can be achieved by connecting vacuum at duct 3 and pressure for the ejector pulse at duct 1.

Valve terminals VTUG with multi-pin plug and fieldbus connection

Key features – Pneumatics

Standard nominal flow rate q_{nN} as a function of the number of switched valves n

Valve size 10 mm, 5/2-way valves

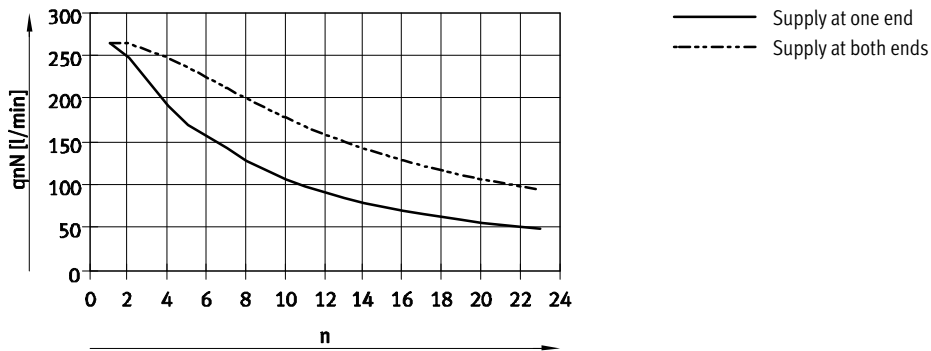

Valve size 14 mm

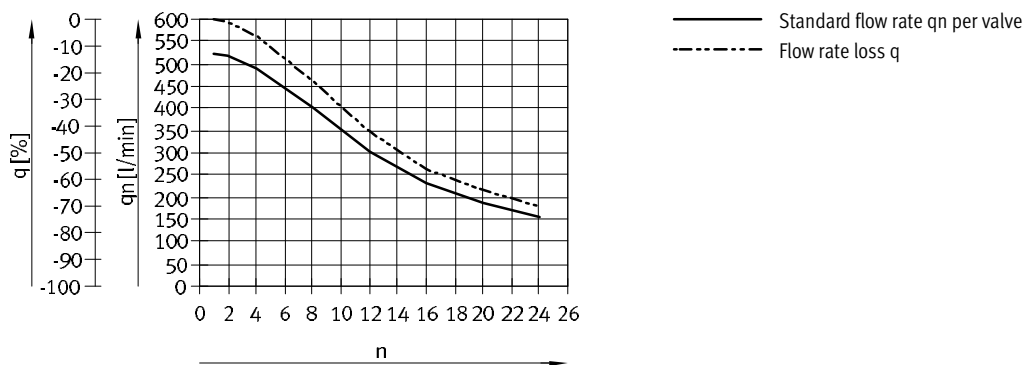

Valve size 18 mm

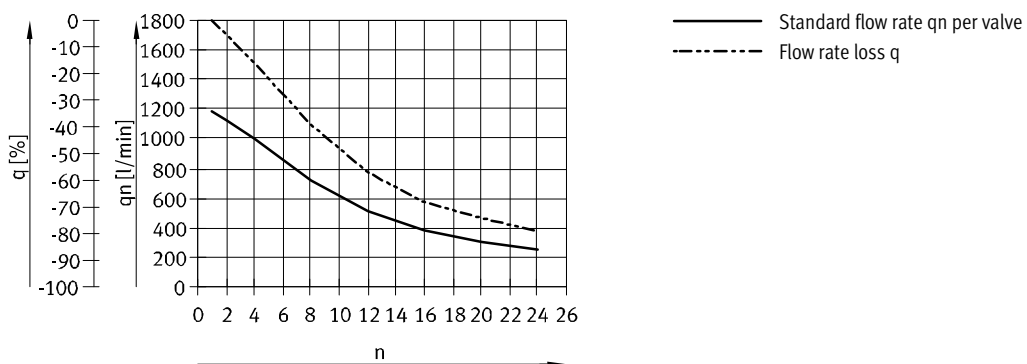

Valve terminals VTUG with multi-pin plug and fieldbus connection

Key features – Pneumatics

Pilot pressure p_2 as a function of operating pressure p_1

2x 3/2-way valve, reset method: mechanical spring



2x 3/2-way valve, reset method: pneumatic spring

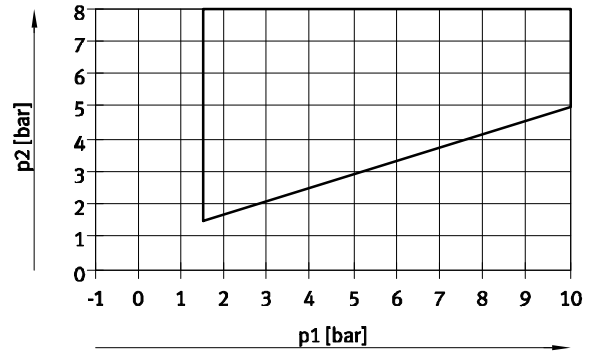

3/2-way single solenoid valve and 5/2-way single solenoid valve

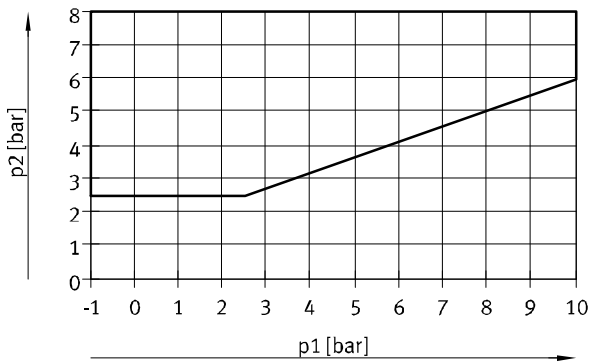

Valve terminals VTUG with multi-pin plug and fieldbus connection

Key features – Assembly

Valve terminal assembly

Sturdy terminal assembly thanks to:

- Four through-holes for wall mounting
- H-rail mounting



Note

Use the M5 thread provided on the manifold block for earthing the valve terminal.

Wall mounting

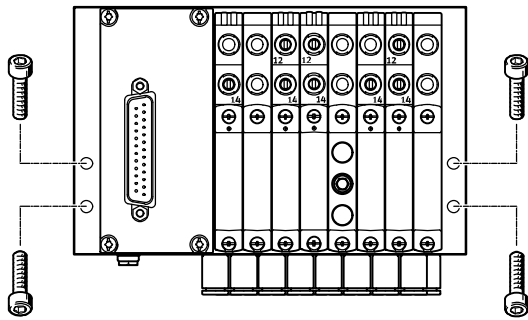

Screw the valve terminal VTUG onto the mounting surface using four M4 screws.

The mounting holes are on the left and right side of the manifold rail.

H-rail mounting

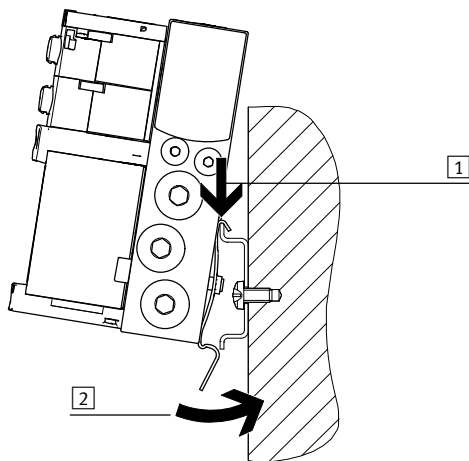

Attach the valve terminal VTUG to the H-rail (see arrow 1).

Swivel the valve terminal onto the H-rail and secure in place with the clamping component (see arrow 2).

Attach the manifold rails to an H-rail to EN 60715-TH35 using the H-rail mounting kit VAME-T-M4.

Use the following screws (to DIN 912) to attach the manifold rails:

- Size 10: M4x30
- Size 14: M4x40
- Size 18: M5x50



Note

Permissible use of the H-rail:

- Manifold rail with outlet on the side or on top.
- H-rail exclusively for horizontal mounting.
- Vibration/shock loads are not permissible for this type of mounting.

Size 14:

- Use H-rail TH35-7.5 for valve terminals with a maximum of 8 valve positions.
- Use H-rail TH35-15 for mounting in accordance with the standard and for more than 8 valve positions.

Valve terminals VTUG with multi-pin plug and fieldbus connection

Key features – Assembly

FESTO

Manual override (MO)

MO with automatic return (non-detenting)

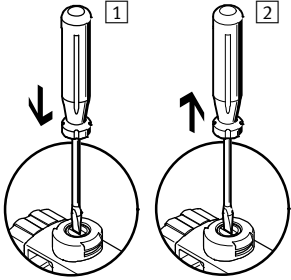

- 1 Press in the stem of the MO with a pointed object or screwdriver. The pilot valve switches and actuates the main valve.
- 2 Remove the pointed object or screwdriver. The spring force pushes the stem of the MO back. The pilot valve returns to its initial position as does the single solenoid main valve (not the case with double solenoid valve code J).

MO with detent (locking)

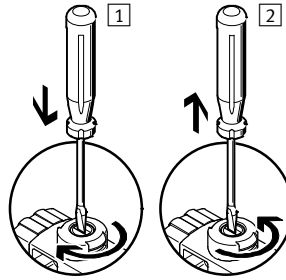

- 1 Press in the stem of the MO with a pointed object or screwdriver until the valve switches and then turn the stem clockwise by 90° until the stop is reached. Valve remains switched.
- 2 Turn the stem anti-clockwise by 90° until the stop is reached and then remove the pointed object or screwdriver. The spring force pushes the stem of the MO back. The valve returns to its initial position (not the case with double solenoid valve code J).

MO non-detenting – with coded cover cap

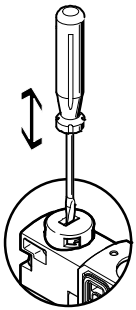

MO is actuated by pushing it with a pointed object or screwdriver and reset by spring force (detenting position prevented by coded cover cap).

MO detenting without tools – assembly

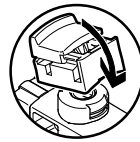

Clip MO with lock onto the pilot valve. The MO cap can then be operated (detenting) without tools.

MO detenting without tools – actuation

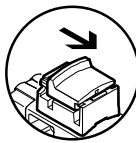

When sliding the cap for the MO in the direction of the arrow:

- The cap locks into the end position.
- The pilot valve switches and actuates the main valve.

MO detenting without tools – actuation

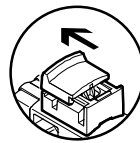

When sliding the cap for the MO in the direction of the arrow:

- The cap locks into the end position.
- The spring force pushes the stem of the MO back.
- The pilot valve returns to its initial position as does the single solenoid main valve (not the case with double solenoid valve code J).

Valve terminals VTUG with multi-pin plug and fieldbus connection

Key features – Assembly

Inscription system

Inscription label holder

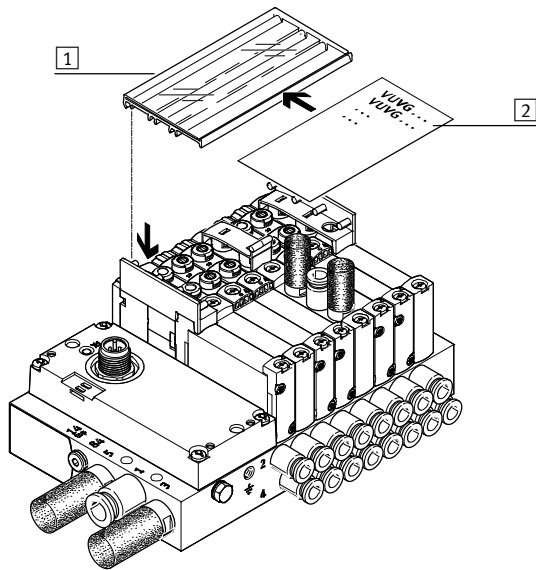

- 1 Inscription label holder
ASCF-H-L1 (code TT)
- 2 Inscription label

Mount the inscription label holder to label the valves. Open the inscription label holder to insert the inscription label and actuate the manual override. The inscription label holders are available in different sizes depending on the number of valve positions.

-  - Note

Do not engage the manual override before mounting the inscription label holder. When mounted, the retainer for the inscription label holder covers the manual override of the valve beneath it. The only way of actuating the manual override is in a non-detenting mode.

Inscription label holder

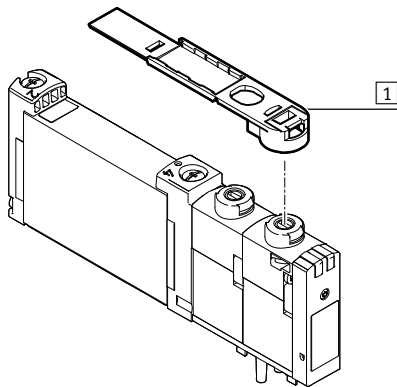

- 1 Inscription label holder
ASLR-D-L1 (code TV)

Use inscription label holder ASLR-D-L1 (code TV) to label individual valves. The inscription label holder is placed directly on the manual override.

-  - Note

Do not engage the manual override before mounting the inscription label holder. After the retainers are in place, the only way of actuating the manual override is in a non-detenting mode.

Valve terminals VTUG with multi-pin plug and fieldbus connection

Overview of valve functions

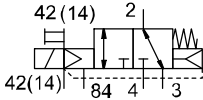
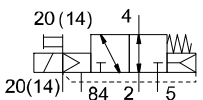
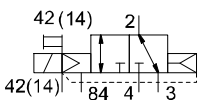
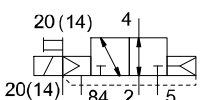
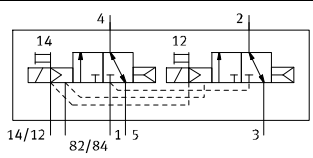
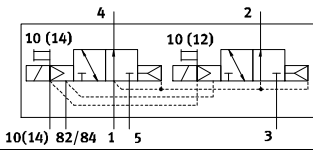
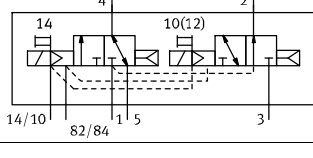
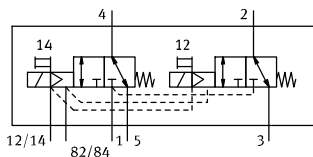
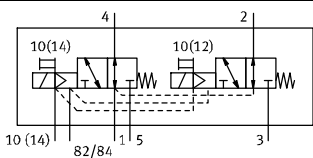
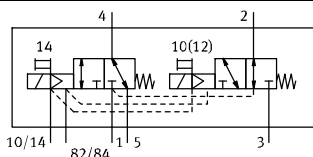
Valve	Valve code	Description	Valve terminal/ position function order code	Size		
				M5/M7	G1/8	G1/4
3/2-way valve, pneumatic/mechanical spring						
	M32C-R	Normally closed	VX	■	-	-
	M32U-R	Normally open	VW	■	-	-
3/2-way valve, pneumatic spring						
	M32C-A	Normally closed	VX	-	■	-
	M32U-A	Normally open	VW	-	■	-
2x 3/2-way valve, pneumatic spring						
	T32C-A	Normally closed	K	■	■	■
	T32U-A	Normally open	N	■	■	■
	T32H-A	1x normally open, 1x normally closed	H	■	■	■
2x 3/2-way valve, mechanical spring						
	T32C-M	Normally closed	VK	■	■	■
	T32U-M	Normally open	VN	■	■	■
	T32H-M	1x normally open, 1x normally closed	VH	■	■	■

Valve terminals VTUG with multi-pin plug and fieldbus connection

Overview of valve functions

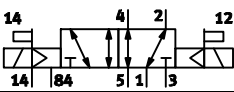
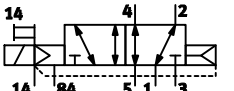
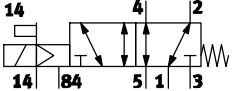
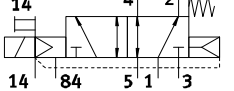
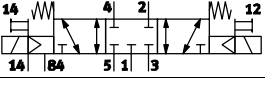
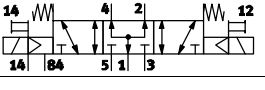
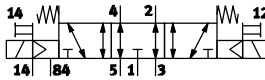
Valve	Valve code	Description	Valve terminal/ position function order code	Size		
				M5/M7	G1/8	G1/4
5/2-way valve, double solenoid						
	B52	External pilot air supply	J	■	■	■
5/2-way valve, single solenoid						
	M52-A	Pneumatic spring	M	-	■	-
	M52-M	Mechanical spring	A	■	■	■
	M52-R	Pneumatic/mechanical spring	P	■	-	■
5/3-way valve						
	P53C	Mid-position closed	G	■	■	■
	P53U	Mid-position pressurised	B	■	■	■
	P53E	Mid-position exhausted	E	■	■	■

Valve terminals VTUG with multi-pin plug and fieldbus connection

Peripherals overview example – Semi in-line valves

Valve terminal overview – Multi-pin plug and I-Port interface

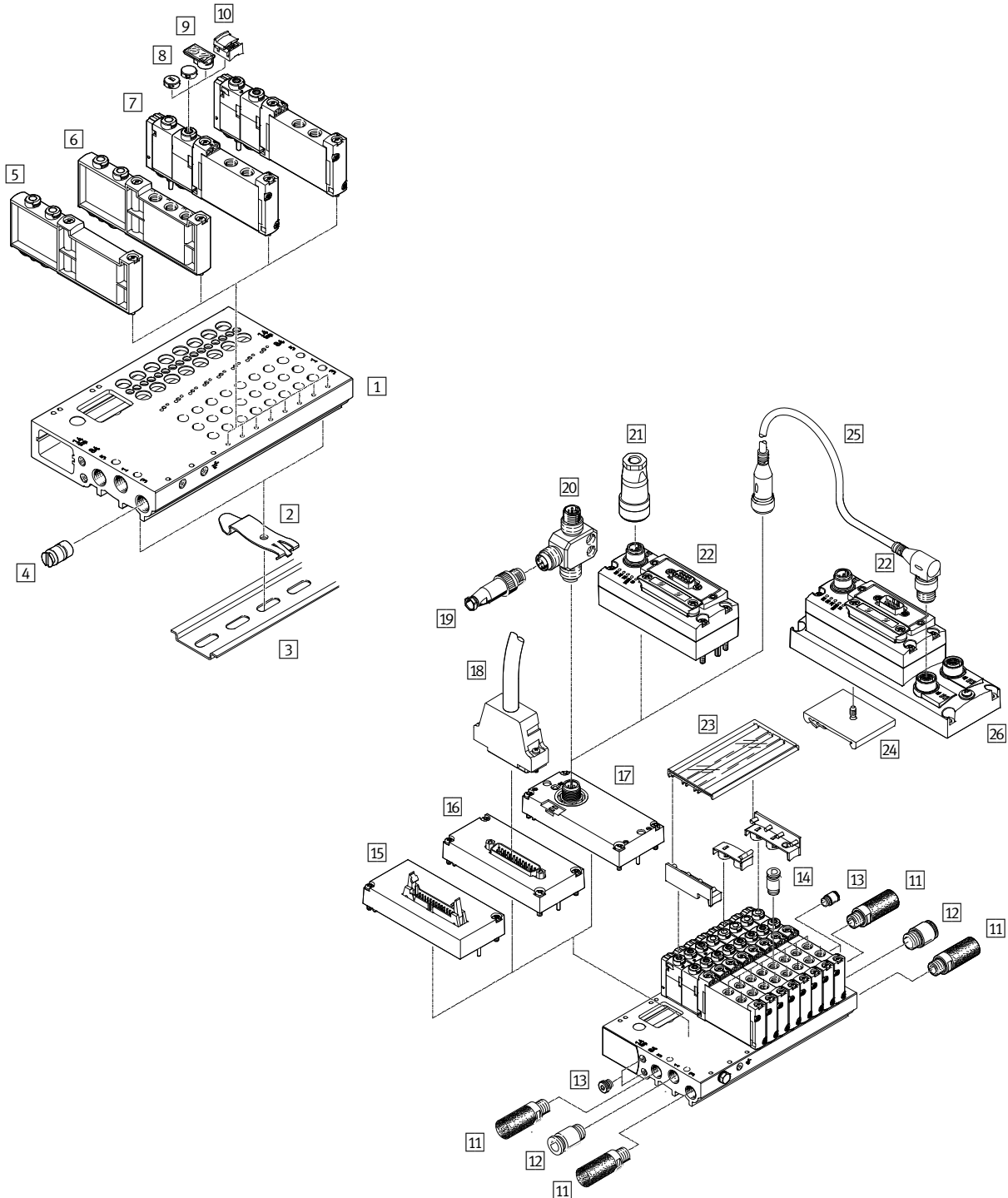

Valve terminals VTUG with multi-pin plug and fieldbus connection

Peripherals overview example – Semi in-line valves

Accessories				
	Type	Description	→ Page/Internet	
1	Manifold rail	VABM-L1-...	For 4 to 10, 12, 16, 20 and 24 valve positions	160
2	H-rail mounting	VAME-T-M4	2 pieces for fitting the valve terminal on an H-rail	201
3	H-rail	NRH-35-2000	For mounting the valve terminal	201
4	Separator	VABD-...	For creating pressure zones	199
5	Blanking plate	VABB-L1-...	For covering an unused valve position	199
6	Supply plate	VABF-L1-...	For air supply at port 1 and ports 3 and 5	199
7	Solenoid valve	VUVG-...	Semi in-line valve	136, 141, 145
8	Cover cap	VMPA-HB...-B	For manual override	199
9	Inscription label holder	ASLR-D-L1	For inscription label and covering the mounting screw/manual override	201
10	Cover	VAMC-...	For manual override	199
11	Silencer	U-...	For ports 3 and 5	199
12	Push-in fitting	QS-...	For air supply, port 1	198
13	Blanking plug	B-...	For internal/external pilot air	198
14	Push-in fitting	QS-...	For ports 2 and 4	198
15	Electrical interface	VAEM-L1-S-M3-...	Flat cable	188
16	Electrical interface	VAEM-L1-S-M1-...	Sub-D	188
17	Electrical interface	VAEM-L1-S-...-PT	I-Port interface/IO-Link	191
18	Connecting cable	NEBV-...	Sub-D cable	188
19	Plug connector	SEA-M12-5GS-PG7	Straight, for T-adapter FB-TA	191
20	T-adapter	FB-TA-M12-5POL	For IO-Link and load voltage supply	191
21	Power supply socket	NTSD-.../FBSD-...	Power supply for CTEU bus nodes	197
22	CTEU	CTEU-...	Bus node	197
23	Inscription label holder	ASCF-H-L1	For identifying valves	201
24	H-rail mounting	CAFM-F1-H	For electrical connection box CAPC	193
25	Connecting cable	NEBU-...	–	nebu
26	Electrical connection box	CAPC-F1-E-M12	For connecting a second device with I-Port interface	193

Valve terminals VTUG with multi-pin plug and fieldbus connection

Peripherals overview example – Sub-base valves

Valve terminal overview – Multi-pin plug and I-Port interface

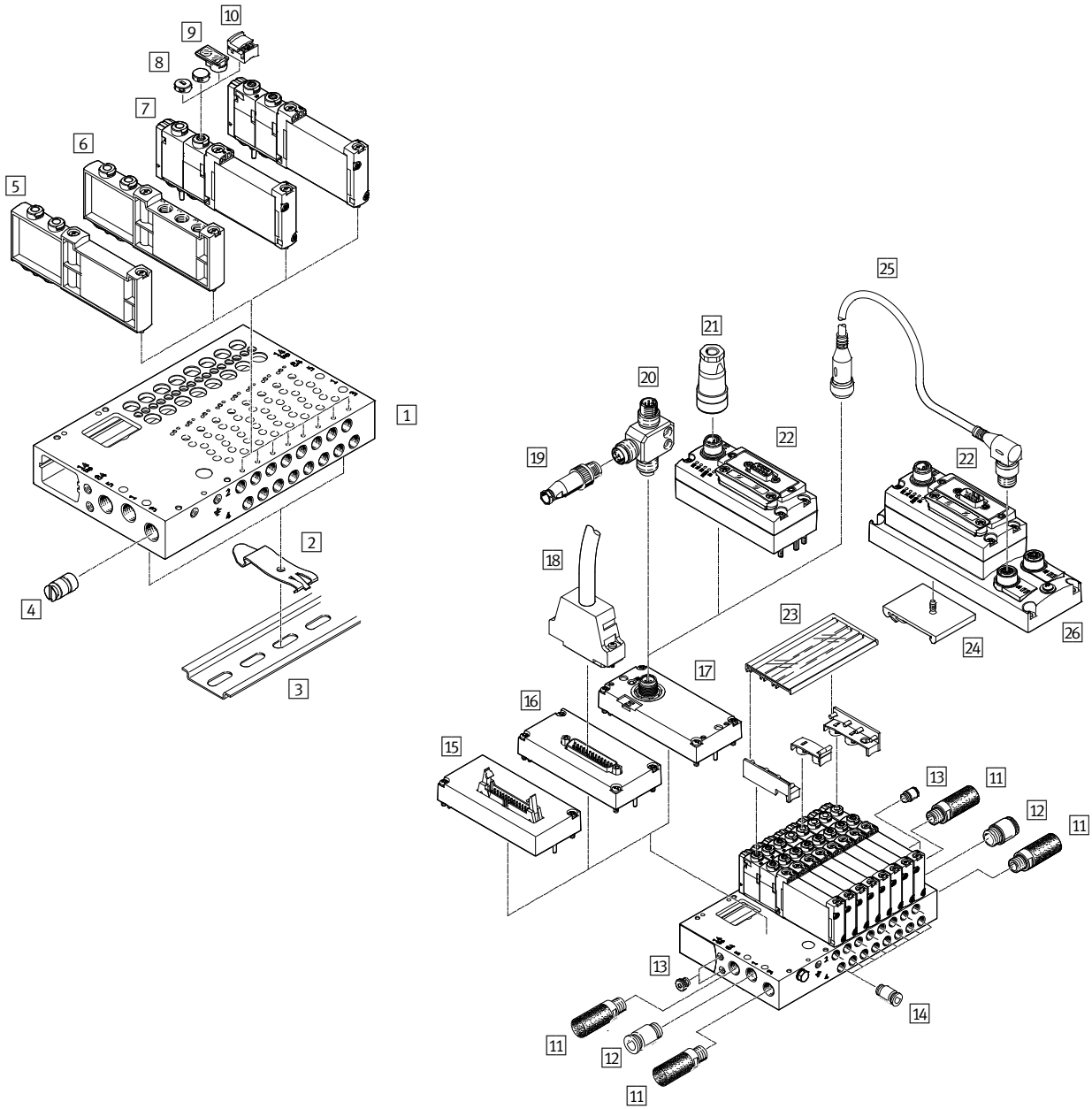

Valve terminals VTUG with multi-pin plug and fieldbus connection

Peripherals overview example – Sub-base valves

Accessories				
	Type	Description	→ Page/Internet	
1	Manifold rail	VABM-L1-...	For 4 to 10, 12, 16, 20 and 24 valve positions	160
2	H-rail mounting	VAME-T-M4	2 pieces for fitting the valve terminal on an H-rail	201
3	H-rail	NRH-35-2000	For mounting the valve terminal	201
4	Separator	VABD-...	For creating pressure zones	199
5	Blanking plate	VABB-L1-...	For covering an unused valve position	199
6	Supply plate	VABF-L1-...	For air supply at port 1 and ports 3 and 5	199
7	Solenoid valve	VUVG- ...	Sub-base valve	149, 153, 157
8	Cover cap	VMPA-HB...-B	For manual override	199
9	Inscription label holder	ASLR-D-L1	For inscription label and covering the mounting screw/manual override	201
10	Cover	VAMC...	For manual override	199
11	Silencer	U...	For ports 3 and 5	199
12	Push-in fitting	QS...	For air supply, port 1	198
13	Blanking plug	B-...	For internal/external pilot air	198
14	Push-in fitting	QS...	For ports 2 and 4	198
15	Electrical interface	VAEM-L1-S-M3-...	Flat cable	188
16	Electrical interface	VAEM-L1-S-M1-...	Sub-D	188
17	Electrical interface	VAEM-L1-S-...-PT	I-Port interface/IO-Link	191
18	Connecting cable	NEBV-...	Sub-D cable	188
19	Plug connector	SEA-M12-5GS-PG7	Straight, for T-adapter FB-TA	191
20	T-adapter	FB-TA-M12-5POL	For IO-Link and load voltage supply	191
21	Power supply socket	FBSD-.../NTSD-...	Power supply for CTEU bus nodes	197
22	CTEU	CTEU-...	Bus node	197
23	Inscription label holder	ASCF-H-L1	For identifying valves	201
24	H-rail mounting	CAFM-F1-H	For electrical connection box CAPC	193
25	Connecting cable	NEBU-...	–	nebu
26	Electrical connection box	CAPC-F1-E-M12	For connecting a second device with I-Port interface	193

Valve terminals VTUG with multi-pin plug and fieldbus connection

Peripherals overview example – Sub-base valves

Valve terminal overview – I-Port interface with interlock

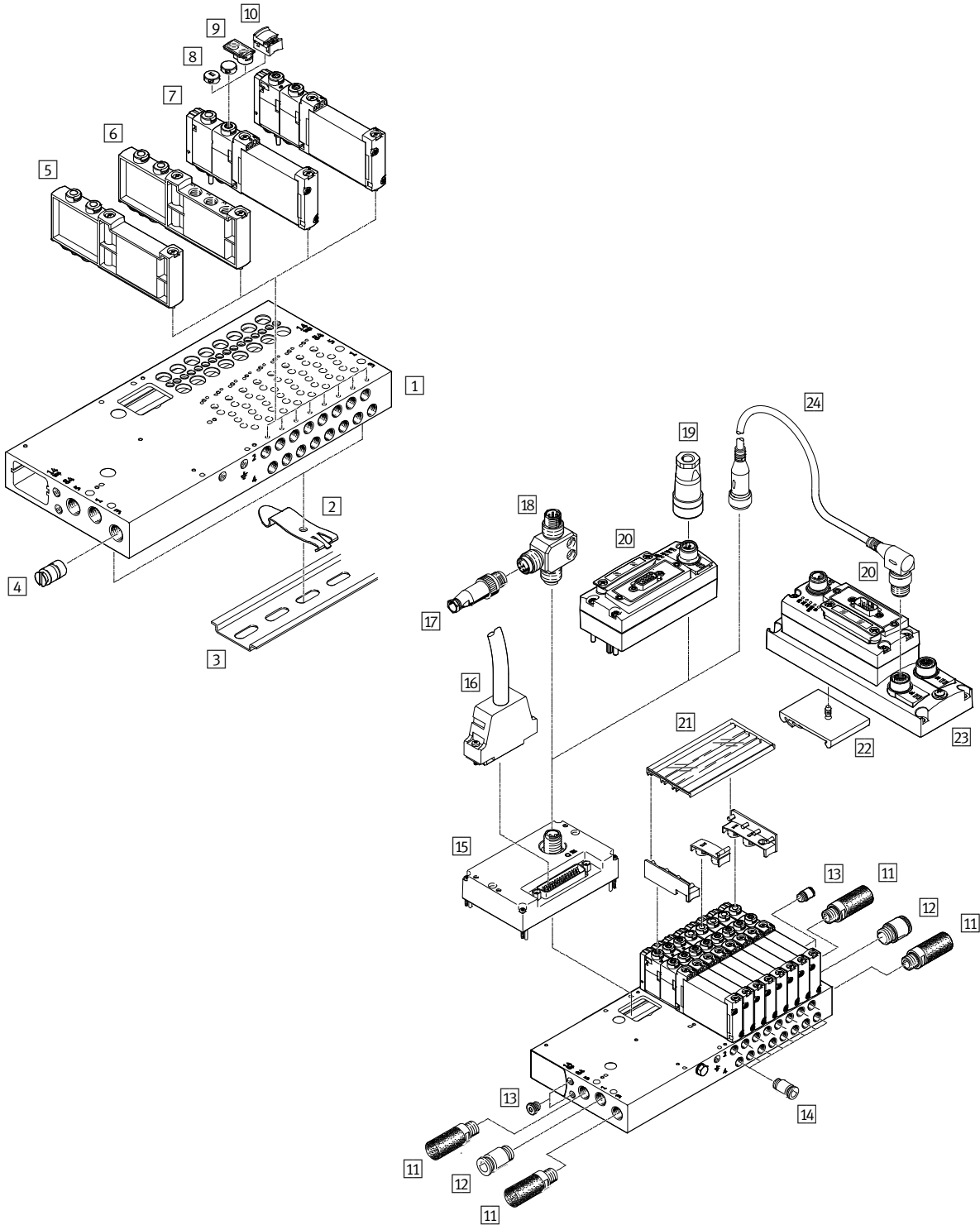

Valve terminals VTUG with multi-pin plug and fieldbus connection

Peripherals overview example – Sub-base valves

Accessories				
	Type	Description	→ Page/Internet	
1	Manifold rail	VABM-L1-...	For 4 to 10, 12, 16, 20 and 24 valve positions	160
2	H-rail mounting	VAME-T-M4	2 pieces for fitting the valve terminal on an H-rail	201
3	H-rail	NRH-35-2000	For mounting the valve terminal	201
4	Separator	VABD-...	For creating pressure zones	199
5	Blanking plate	VABB-L1-...	For covering an unused valve position	199
6	Supply plate	VABF-L1-...	For air supply at port 1 and ports 3 and 5	199
7	Solenoid valve	VUVG-...	–	149, 153, 157
8	Cover cap	VMPA-HB...-B	For manual override	199
9	Inscription label holder	ASLR-D-L1	For inscription label and covering the mounting screw/manual override	201
10	Cover	VAMC-...	For manual override	199
11	Silencer	U-...	For ports 3 and 5	199
12	Push-in fitting	QS-...	For air supply, port 1	198
13	Blanking plug	B-...	For internal/external pilot air	198
14	Push-in fitting	QS-...	For ports 2 and 4	198
15	Electrical interface	VAEM-L1-S-24-...	I-Port interface with interlock	194
16	Connecting cable	NEBV-...	Sub-D cable	188
17	Plug connector	SEA-M12-5GS-PG7	Straight, for T-adapter FB-TA	191
18	T-adapter	FB-TA-M12-5POL	For IO-Link and load voltage supply	191
19	Power supply socket	NTSD-.../FBSD-...	Power supply for CTEU bus nodes	197
20	CTEU	CTEU-...	Bus node	197
21	Inscription label holder	ASCF-H-L1	For identifying valves	201
22	H-rail mounting	CAFM-F1-H	For electrical connection box CAPC	193
23	Electrical connection box	CAPC-F1-E-M12	For connecting a second device with I-Port interface	193
24	Connecting cable	NEBU-...	–	nebu

Valve terminals VTUG with multi-pin plug and fieldbus connection

Peripherals overview example – Sub-base valves

Valve terminal with multi-pin plug/fieldbus connection and individually electrically actuated valves

In applications with specific emergency off requirements, it may be necessary to switch one or more valves separately from the valve terminal controller.

Valves VUVG (see → page 11) with an individual electrical connection are therefore on the valve terminal.

Valves with an individual electrical connection require a special seal when mounted on a valve terminal.

They are therefore ordered/fitted as follows:

- together with the valve terminal using the valve terminal configurator
- individually/subsequently as a substitute for a blanking plate in a vacant position

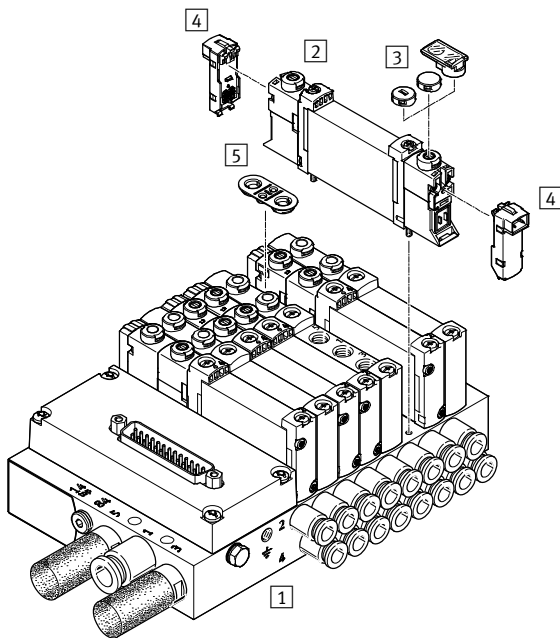

Accessories				
	Type	Description	→ Page/Internet	
1	Manifold rail	VABM-L1-10	For 2 to 10, 12 and 16 valve positions	160
2	Solenoid valve	VUVG	Sub-base valve	79
3	Cover cap	VMPA	For manual override	110
4	Electrical connection box	VAVE	For individual connection	103
5	Seal	–	Included in the scope of delivery of the blanking plate for a vacant position	199

Valve terminals VTUG with multi-pin plug and fieldbus connection

Order code – Semi in-line valves M5/M7

VUVG	-	S	10	-	
Valve design					
Semi in-line valve			S		
Valve size					
10 mm			10		
Valve functions					
				M52	
				B52	
				P53C	
				P53U	
				P53E	
				T32C	
				T32H	
				T32U	

Z	-		1	T1	L
Display					
				L	LED
Electrical connection					
				T1	Plug-in
Nominal operating voltage					
1				24 V DC	
Pneumatic connection					
M5		M5 thread			
M7		M7 thread			
Q3		Push-in connector 3 mm			
Q4		Push-in connector 4 mm			
Q4H		Push-in connector 4 mm, M7			
Q6		Push-in connector 6 mm			
Q6H		Push-in connector 6 mm, M7			
T14		Push-in connector 1/4"			
T14H		Push-in connector 1/4", M7			
T18		Push-in connector 1/8"			
T316		Push-in connector 3/16"			
T316H		Push-in connector 3/16", M7			
T532		Push-in connector 5/32"			
Manual override					
H		Non-detenting			
S		Covered			
T		Non-detenting, detenting			
Y		Detenting, without accessories			
Pilot air					
Z		External			
Reset method					
A		Pneumatic spring with T32			
M		Mechanical spring with T32 and M52			
R		Pneumatic/mechanical spring with M52			
-		With B52 and P53			

Valve terminals VTUG with multi-pin plug and fieldbus connection



FESTO

Technical data – Semi in-line valves M5/M7

Function

2x 3/2C, 2x 3/2U, 2x 3/2H
 5/2-way, single solenoid
 5/2-way, double solenoid
 5/3C, 5/3U, 5/3E

Circuit symbol → Page 13

-  - Valve size 10 mm
-  - Flow rate
130 ... 330 l/min
-  - Voltage
24 V DC



General technical data													
Valve function	T32-A			T32-M			M52-R	B52	M52-M	P53			
Normal position	C ¹⁾	U ²⁾	H ⁴⁾	C ¹⁾	U ²⁾	H ⁴⁾	-	-	-	C ¹⁾	U ²⁾	E ³⁾	
Stable position	Monostable							Bistable	Monostable				
Reset method: pneumatic spring	Yes			No			Yes ⁵⁾	-	No	-			
Reset method: mechanical spring	No			Yes			Yes ⁵⁾	-	Yes	-			
Vacuum operation at port 1	No			With external pilot air									
Design	Piston spool												
Sealing principle	Soft												
Actuation type	Electrical												
Type of control	Pilot												
Pilot air supply	External												
Exhaust function	With flow control												
Manual override	Choice of non-detenting, covered, non-detenting/detenting or detenting												
Type of mounting	On manifold rail												
Mounting position	Any												
Switching position display	LED												
Flow rate on manifold rail M5	[l/min]	150			130			230		210			
Flow rate on manifold rail M7	[l/min]	160			140			330		290		280	
Valve size	[mm]	10											
Port	1, 3, 5, 12/14, 82/84	On manifold rail											
	2, 4	M5 (VUVG-S10-...-M5) M7 (VUVG-S10-...-M7)											
Product weight	[g]	59					53		60		53		58
Certification	c UL us - Recognized (OL)												
	c CSA us (OL)												
	RCM												
CE marking (see declaration of conformity) ⁶⁾	In accordance with EU EMC Directive												
Corrosion resistance class CRC ⁷⁾	2												

- 1) C=Normally closed/mid-position closed
- 2) U=Normally open/mid-position pressurised
- 3) E=Mid-position exhausted
- 4) H=2x 3/2-way valve in one housing with 1x normally closed and 1x normally open
- 5) Combined reset method
- 6) For information about the applicability of the component see the manufacturer's EC declaration of conformity at: www.festo.com/sp → Certificates.
If the component is subject to restrictions on usage in residential, office or commercial environments or small businesses, further measures to reduce the emitted interference may be necessary.
- 7) Corrosion resistance class CRC 2 to Festo standard FN 940070
Moderate corrosion stress. Indoor applications in which condensation may occur. External visible parts with primarily decorative requirements for the surface and which are in direct contact with the ambient atmosphere typical for industrial applications.

Valve terminals VTUG with multi-pin plug and fieldbus connection

Technical data – Semi in-line valves M5/M7

Operating and environmental conditions								
Valve function			T32-A ¹⁾	T32-M ³⁾	M52-R ²⁾	B52	M52-M ³⁾	P53
Operating medium		Compressed air to ISO 8573-1:2010 [7:4:4]						
Operating pressure	Internal pilot air supply	[bar]	1.5 ... 8	2 ... 8	2.5 ... 8	1.5 ... 8	3 ... 8	3 ... 8
	External pilot air supply	[bar]	1.5 ... 10	-0.9 ... 10			-0.9 ... 8	-0.9 ... 10
Pilot pressure ⁴⁾		[bar]	1.5 ... 8	2 ... 8	2.5 ... 8	1.5 ... 8	3 ... 8	3 ... 8
Ambient temperature		[°C]	-5 ... +60					
Temperature of medium		[°C]	-5 ... +60					

- 1) Pneumatic spring
- 2) Mixed, pneumatic/mechanical spring
- 3) Mechanical spring
- 4) Minimum pilot pressure 50% of operating pressure

Electrical data		
Electrical connection		Via sub-base
Operating voltage	[V DC]	24 ±10%
Power consumption per valve solenoid	[W]	1/0.4 (after 25 ms)
Duty cycle	[%]	100
Max. switching frequency	[Hz]	3
Degree of protection to	Individual valve	IP67/IP65
EN 60529	Valve terminal	IP40, IP67/IP65

Safety data		
Max. positive test pulse with 0 signal	[µs]	1600
Max. negative test pulse with 1 signal	[µs]	3000
Shock resistance	Shock test with severity level 2 to FN 942017-5 and EN 60068-2-27	
Vibration resistance	Transport application test with severity level 2 to FN 942017-4 and EN 60068-2-6	

Information on materials	
Housing	Wrought aluminium alloy
Seals	HNBR, NBR
Note on materials	RoHS compliant

Valve switching times								
Valve function			T32-A ¹⁾	T32-M ³⁾	M52-R ²⁾	B52	M52-M ³⁾	P53
Switching time on	[ms]	8	10	9	-	12	12	
Switching time off	[ms]	20	20	21	-	30	38	
Changeover time	[ms]	-	-	-	9	-	16	

- 1) Pneumatic spring
- 2) Mixed, pneumatic/mechanical spring
- 3) Mechanical spring

Valve terminals VTUG with multi-pin plug and fieldbus connection

Technical data – Semi in-line valves M5/M7

Dimensions Download CAD data → www.festo.com

Semi in-line valves M5/M7

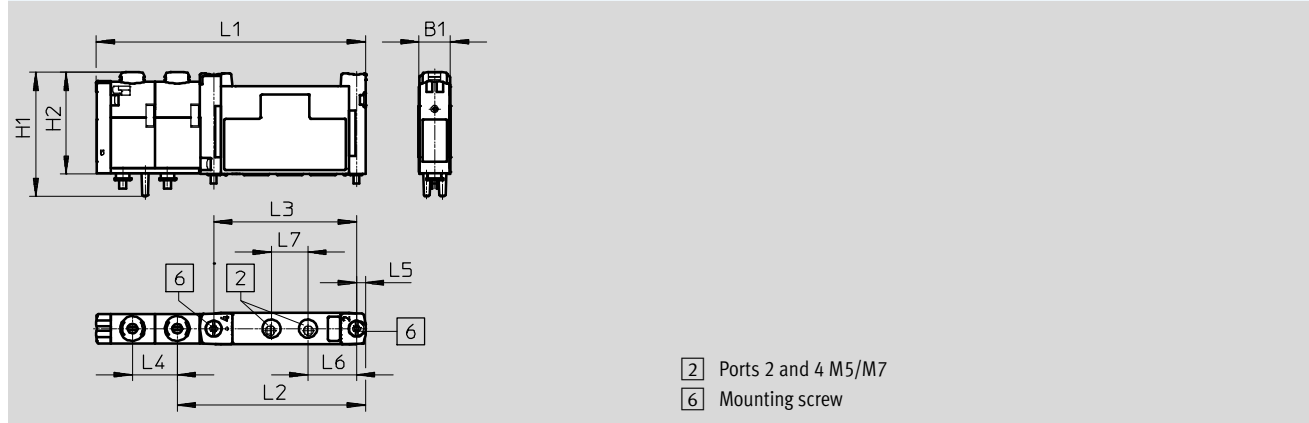

Type	B1	H1	H2	L1	L2	L3	L4	L5	L6	L7
VUVG-S10-...-M5-1T1L	10.3	40.7	33.6	88.6	62	47	14.7	3	16	12
VUVG-S10-...-M7-1T1L										

Ordering data

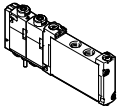
Description	Part No.	Type	
Semi in-line valve M5			
 2x 3/2-way valve External pilot air supply	Normally closed, reset method: pneumatic spring	573386 VUVG-S10-T32C-AZT-M5-1T1L	
	Normally open, reset method: pneumatic spring	573387 VUVG-S10-T32U-AZT-M5-1T1L	
	1x normally open, 1x normally closed, reset method: pneumatic spring	573388 VUVG-S10-T32H-AZT-M5-1T1L	
	Normally closed, reset method: mechanical spring	573389 VUVG-S10-T32C-MZT-M5-1T1L	
	Normally open, reset method: mechanical spring	573390 VUVG-S10-T32U-MZT-M5-1T1L	
	1x normally open, 1x normally closed, reset method: mechanical spring	573391 VUVG-S10-T32H-MZT-M5-1T1L	
	5/2-way valve, single solenoid		
	External pilot air supply	Reset method: mechanical spring	573393 VUVG-S10-M52-MZT-M5-1T1L
		Reset method: pneumatic/mechanical spring	573392 VUVG-S10-M52-RZT-M5-1T1L
	5/2-way valve, double solenoid		
External pilot air supply		573394 VUVG-S10-B52-ZT-M5-1T1L	
5/3-way valve			
External pilot air supply	Mid-position closed	573395 VUVG-S10-P53C-ZT-M5-1T1L	
	Mid-position pressurised	573397 VUVG-S10-P53U-ZT-M5-1T1L	
	Mid-position exhausted	573396 VUVG-S10-P53E-ZT-M5-1T1L	

Valve terminals VTUG with multi-pin plug and fieldbus connection

Ordering data

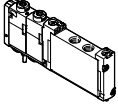
Ordering data					
	Description		Part No.	Type	
Semi in-line valve M7					
	2x 3/2-way valve				
	External pilot air supply	Normally closed, reset method: pneumatic spring		573398	VUVG-S10-T32C-AZT-M7-1T1L
		Normally open, reset method: pneumatic spring		573399	VUVG-S10-T32U-AZT-M7-1T1L
		1x normally open, 1x normally closed, reset method: pneumatic spring		573400	VUVG-S10-T32H-AZT-M7-1T1L
		Normally closed, reset method: mechanical spring		573401	VUVG-S10-T32C-MZT-M7-1T1L
		Normally open, reset method: mechanical spring		573402	VUVG-S10-T32U-MZT-M7-1T1L
		1x normally open, 1x normally closed, reset method: mechanical spring		573403	VUVG-S10-T32H-MZT-M7-1T1L
	5/2-way valve, single solenoid				
	External pilot air supply	Reset method: mechanical spring		573405	VUVG-S10-M52-MZT-M7-1T1L
		Reset method: pneumatic/mechanical spring		573404	VUVG-S10-M52-RZT-M7-1T1L
	5/2-way valve, double solenoid				
	External pilot air supply			573406	VUVG-S10-B52-ZT-M7-1T1L
	5/3-way valve				
	External pilot air supply	Mid-position closed		573407	VUVG-S10-P53C-ZT-M7-1T1L
Mid-position pressurised			573409	VUVG-S10-P53U-ZT-M7-1T1L	
Mid-position exhausted			573408	VUVG-S10-P53E-ZT-M7-1T1L	

Valve terminals VTUG with multi-pin plug and fieldbus connection

Order code – Semi in-line valves G1/8

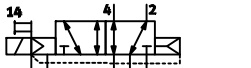
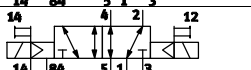
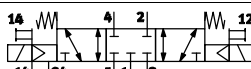
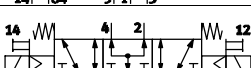
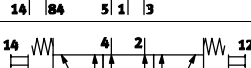
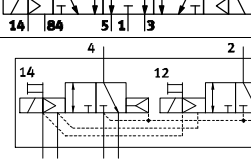
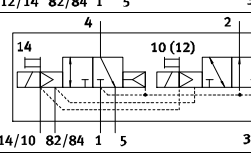
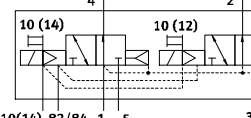
VUVG	-	S	14	-		-
Valve design						
Semi in-line valve						
Valve size						
14 mm						
Valve functions						
						M52
						B52
						P53C
						P53U
						P53E
						T32C
						T32H
						T32U

Z	-	1	T1	L
Display				
L LED				
Electrical connection				
T1 Plug-in				
Nominal operating voltage				
1 24 V DC				
Pneumatic connection				
G18 G1/8 thread				
T14 Push-in connector 1/4"				
T516 Push-in connector 5/16"				
Q4 Push-in connector 4 mm				
Q6 Push-in connector 6 mm				
Q8 Push-in connector 8 mm				
Manual override				
H Non-detenting				
S Covered				
T Non-detenting, detenting				
Y Detenting, without accessories				
Pilot air				
Z External				
Reset method				
A Pneumatic spring with M52 and T32				
M Mechanical spring with M52 and T32				
- With B52 and P53				

Valve terminals VTUG with multi-pin plug and fieldbus connection

Technical data – Semi in-line valves G1/8

Function

2x 3/2C, 2x 3/2U, 2x 3/2H

5/2-way, single solenoid

5/2-way, double solenoid

5/3C, 5/3U, 5/3E

Circuit symbol → Page 13

-  - Valve size 14 mm

-  - Flow rate
520 ... 630 l/min

-  - Voltage
24 V DC



General technical data												
Valve function	T32-A			T32-M			M52-A	B52	M52-M	P53		
Normal position	C ¹⁾	U ²⁾	H ⁴⁾	C ¹⁾	U ²⁾	H ⁴⁾	–	–	–	C ¹⁾	U ²⁾	E ³⁾
Stable position	Monostable							Bistable	Monostable			
Reset method: pneumatic spring	Yes			No			Yes	–	No	–		
Reset method: mechanical spring	No			Yes			No	–	Yes	–		
Vacuum operation at port 1	No			With external pilot air								
Design	Piston spool											
Sealing principle	Soft											
Actuation type	Electrical											
Type of control	Pilot											
Pilot air supply	External											
Exhaust function	With flow control											
Manual override	Choice of non-detenting, covered, non-detenting/detenting or detenting											
Type of mounting	On manifold rail											
Mounting position	Any											
Switching position display	LED											
Flow rate on manifold rail G ^{1/8}	[l/min]	610			520			620	630	620	590	
Valve size	[mm]	14										
Port	1, 3, 5, 12/14, 82/84	On manifold rail										
	2, 4	G1/8										
Product weight	[g]	102			100			91	98	89	95	
Certification	c UL us - Recognized (OL)											
	c CSA us (OL)											
	RCM											
CE marking (see declaration of conformity) ⁵⁾	In accordance with EU EMC Directive											
Corrosion resistance class CRC ⁶⁾	2											

1) C=Normally closed/mid-position closed

2) U=Normally open/mid-position pressurised

3) E=Mid-position exhausted

4) H=2x 3/2-way valve in one housing with 1x normally closed and 1x normally open

5) For information about the applicability of the component see the manufacturer's EC declaration of conformity at: www.festo.com/sp → Certificates.

If the component is subject to restrictions on usage in residential, office or commercial environments or small businesses, further measures to reduce the emitted interference may be necessary.

6) Corrosion resistance class CRC 2 to Festo standard FN 940070

Moderate corrosion stress. Indoor applications in which condensation may occur. External visible parts with primarily decorative requirements for the surface and which are in direct contact with the ambient atmosphere typical for industrial applications.

Valve terminals VTUG with multi-pin plug and fieldbus connection

FESTO

Technical data – Semi in-line valves G1/8

Operating and environmental conditions							
Valve function		T32-A ¹⁾	T32-M ²⁾	M52-A ¹⁾	B52	M 52-M ²⁾	P53
Operating medium		Compressed air to ISO 8573-1:2010 [7:4:4]					
Operating pressure	Internal pilot air supply [bar]	1.5 ... 8	2 ... 8	2.5 ... 8	1.5 ... 8	3 ... 8	3 ... 8
	External pilot air supply [bar]	1.5 ... 10	-0.9 ... 10			-0.9 ... 8	-0.9 ... 10
Pilot pressure ³⁾ [bar]		1.5 ... 8	2 ... 8	2.5 ... 8	1.5 ... 8	3 ... 8	3 ... 8
Ambient temperature [°C]		-5 ... +60					
Temperature of medium [°C]		-5 ... +60					

1) Pneumatic spring

2) Mechanical spring

3) Minimum pilot pressure 50% of operating pressure

Electrical data		
Electrical connection		Via sub-base
Operating voltage [V DC]	24 ±10%	
Power [W]	1/0.4 (after 25 ms)	
Duty cycle [%]	100	
Max. switching frequency [Hz]	3	
Degree of protection to EN 60529	Individual valve	IP67/IP65
	Valve terminal	IP40, IP67/IP65

Safety data		
Max. positive test pulse with 0 signal [µs]	1600	
Max. negative test pulse with 1 signal [µs]	3000	
Shock resistance	Shock test with severity level 2 to FN 942017-5 and EN 60068-2-27	
Vibration resistance	Transport application test with severity level 2 to FN 942017-4 and EN 60068-2-6	

Information on materials	
Housing	Wrought aluminium alloy
Seals	HNBR, NBR
Note on materials	RoHS compliant

Valve switching times							
Valve function		T32-A ¹⁾	T32-M ²⁾	M52-A ¹⁾	B52	M 52-M ²⁾	P53
Switching time on [ms]		10	13	13	–	10	15
Switching time off [ms]		29	21	26	–	38	42
Changeover time [ms]		–	–	–	9	–	25

1) Pneumatic spring

2) Mechanical spring

Valve terminals VTUG with multi-pin plug and fieldbus connection

Technical data – Semi in-line valves G1/8

Dimensions

Download CAD data → www.festo.com

Semi in-line valves G1/8

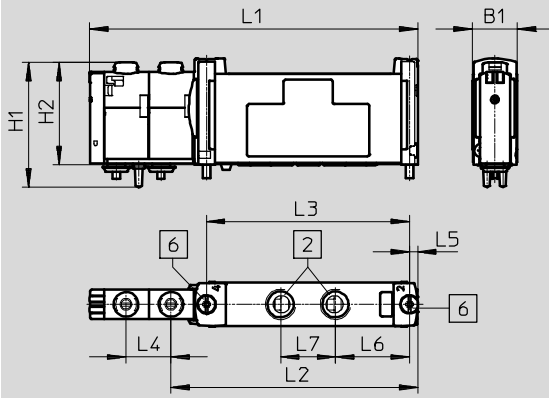

- 2 Ports 2 and 4
- 6 Mounting screw

Type	B1	H1	H2	L1	L2	L3	L4	L5	L6	L7
VUVG-S14-...-G18-1T1L	14.7	40.9	33.5	107.6	81	66.5	14.7	2.8	24.3	18

Ordering data

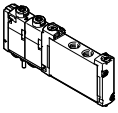
Description		Part No.	Type	
Semi in-line valve G1/8				
	2x 3/2-way valve			
	External pilot air supply	Normally closed, reset method: pneumatic spring	573464	VUVG-S14-T32C-AZT-G18-1T1L
		Normally open, reset method: pneumatic spring	573465	VUVG-S14-T32U-AZT-G18-1T1L
		1x normally open, 1x normally closed, reset method: pneumatic spring	573466	VUVG-S14-T32H-AZT-G18-1T1L
		Normally closed, reset method: mechanical spring	573467	VUVG-S14-T32C-MZT-G18-1T1L
		Normally open, reset method: mechanical spring	573468	VUVG-S14-T32U-MZT-G18-1T1L
		1x normally open, 1x normally closed, reset method: mechanical spring	573469	VUVG-S14-T32H-MZT-G18-1T1L
	5/2-way valve, single-solenoid			
	External pilot air supply	Reset method: pneumatic spring	573470	VUVG-S14-M52-AZT-G18-1T1L
		Reset method: mechanical spring	573471	VUVG-S14-M52-MZT-G18-1T1L
5/2-way valve, double solenoid				
External pilot air supply		573472	VUVG-S14-B52-ZT-G18-1T1L	
5/3-way valve				
External pilot air supply	Mid-position closed	573473	VUVG-S14-P53C-ZT-G18-1T1L	
	Mid-position pressurised	573475	VUVG-S14-P53U-ZT-G18-1T1L	
	Mid-position exhausted	573474	VUVG-S14-P53E-ZT-G18-1T1L	

Valve terminals VTUG with multi-pin plug and fieldbus connection

Order code – Semi in-line valves G1/4

VUVG	-	S	18	-	
Valve design					
Semi in-line valve			S		
Valve size					
18 mm			18		
Valve functions					
				M52	
				B52	
				P53C	
				P53U	
				P53E	
				T32C	
				T32H	
				T32U	

Z	-		-	1	T1	L
Display						
					L	LED
Electrical connection						
					T1	Plug-in
Nominal operating voltage						
1					24 V DC	
Pneumatic connection						
G14		G1/4 thread				
Q6		Push-in connector 6 mm				
Q8		Push-in connector 8 mm				
Q10		Push-in connector 10 mm				
T14		Push-in connector 1/4"				
T516		Push-in connector 5/16"				
T38		Push-in connector 3/8"				
Manual override						
H		Non-detenting				
S		Covered				
T		Non-detenting, detenting				
Y		Detenting, without accessories				
Pilot air						
Z		External				
Reset method						
A		Pneumatic spring with T32				
M		Mechanical spring with M52 and T32				
R		Pneumatic/mechanical spring with M52				
-		With B52 and P53				



Valve terminals VTUG with multi-pin plug and fieldbus connection

Technical data – Semi in-line valves G1/4

Function

2x 3/2C, 2x 3/2U, 2x 3/2H
 5/2-way, single solenoid
 5/2-way, double solenoid
 5/3C, 5/3U, 5/3E

Circuit symbol → Page 13

-  - Valve size 18 mm
-  - Flow rate 900 ... 1200 l/min
-  - Voltage 24 V DC

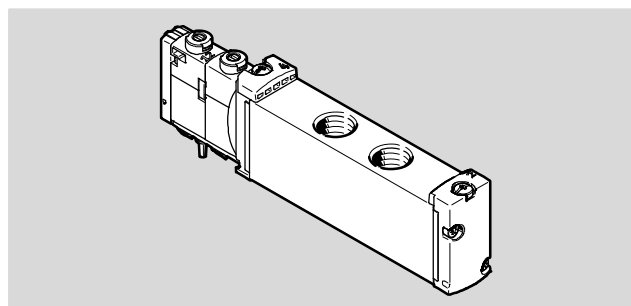

General technical data												
Valve function	T32-A			T32-M			M52-R	B52	M52-M	P53		
Normal position	C ¹⁾	U ²⁾	H ⁴⁾	C ¹⁾	U ²⁾	H ⁴⁾	–	–	–	C ¹⁾	U ²⁾	E ³⁾
Stable position	Monostable							Bistable	Monostable			
Reset method: pneumatic spring	Yes			No			Yes ⁵⁾	–	No	–		
Reset method: mechanical spring	No			Yes			Yes ⁵⁾	–	Yes	–		
Vacuum operation at port 1	No			With external pilot air								
Design	Piston spool											
Sealing principle	Soft											
Actuation type	Electrical											
Type of control	Pilot											
Pilot air supply	External											
Exhaust function	With flow control											
Manual override	Choice of non-detenting, covered, non-detenting/detenting or detenting											
Type of mounting	On manifold rail											
Mounting position	Any											
Switching position display	LED											
Flow rate on manifold rail G ^{1/8}	[l/min]	900			900			1150	1200	1150	1000	
Valve size	[mm]	18										
Port	1, 3, 5, 12/14, 82/84		On manifold rail									
	2, 4		G1/4									
Product weight	[g]	145			147			138	145	138	140	
Certification	c UL us - Recognized (OL)											
	c CSA us (OL)											
	RCM											
CE marking (see declaration of conformity) ⁶⁾	In accordance with EU EMC Directive											
Corrosion resistance class CRC ⁷⁾	2											

1) C=Normally closed/mid-position closed
 2) U=Normally open/mid-position pressurised
 3) E=Mid-position exhausted
 4) H=2x 3/2-way valve in one housing with 1x normally closed and 1x normally open
 5) Combined reset method
 6) For information about the applicability of the component see the manufacturer's EC declaration of conformity at: www.festo.com/sp → Certificates.
 If the component is subject to restrictions on usage in residential, office or commercial environments or small businesses, further measures to reduce the emitted interference may be necessary.
 7) Corrosion resistance class CRC 2 to Festo standard FN 940070
 Moderate corrosion stress. Indoor applications in which condensation may occur. External visible parts with primarily decorative requirements for the surface and which are in direct contact with the ambient atmosphere typical for industrial applications.

Valve terminals VTUG with multi-pin plug and fieldbus connection

FESTO

Technical data – Semi in-line valves G1/4

Operating and environmental conditions							
Valve function		T32-A ¹⁾	T32-M ²⁾	M52-R ³⁾	B52	M52-M ²⁾	P53
Operating medium		Compressed air to ISO 8573-1:2010 [7:4:4]					
Pilot medium		Compressed air to ISO 8573-1:2010 [7:4:4]					
Note on operating/pilot medium		Lubricated operation possible (in which case lubricated operation will always be required)					
Operating pressure	Internal pilot air supply [bar]	1.5 ... 8	2 ... 8	2.5 ... 8	1.5 ... 8	3 ... 8	3 ... 8
	External pilot air supply [bar]	1.5 ... 10	-0.9 ... 10				-0.9 ... 8
Pilot pressure ⁴⁾	[bar]	1.5 ... 8	2 ... 8	2.5 ... 8	1.5 ... 8	3 ... 8	3 ... 8
Ambient temperature	[°C]	-5 ... +60					
Temperature of medium	[°C]	-5 ... +60					

- 1) Pneumatic spring
- 2) Mechanical spring
- 3) Mixed, pneumatic/mechanical spring
- 4) Minimum pilot pressure 50% of operating pressure

Electrical data		
Electrical connection		Via sub-base
Operating voltage	[V DC]	24 ±10%
Power	[W]	1
Duty cycle	[%]	100
Max. switching frequency	[Hz]	3
Degree of protection to EN 60529	Individual valve	IP67/IP65
	Valve terminal	IP40, IP67/IP65

Safety data		
Max. positive test pulse with 0 signal	[µs]	1600
Max. negative test pulse with 1 signal	[µs]	3000
Shock resistance		Shock test with severity level 2 to FN 942017-5 and EN 60068-2-27
Vibration resistance		Transport application test with severity level 2 to FN 942017-4 and EN 60068-2-6

Information on materials	
Housing	Wrought aluminium alloy
Seals	HNBR, NBR
Note on materials	RoHS compliant

Valve switching times							
Valve function		T32-A ¹⁾	T32-M ²⁾	M52-R ³⁾	B52	M52-M ²⁾	P53
Switching time on	[ms]	15	25	20	–	13	20
Switching time off	[ms]	35	33	35	–	50	57
Changeover time	[ms]	–	–	–	15	–	31

- 1) Pneumatic spring
- 2) Mechanical spring
- 3) Mixed, pneumatic/mechanical spring

Valve terminals VTUG with multi-pin plug and fieldbus connection

Technical data – Semi in-line valves G1/4

Dimensions

Download CAD data → www.festo.com

Semi in-line valve G1/4

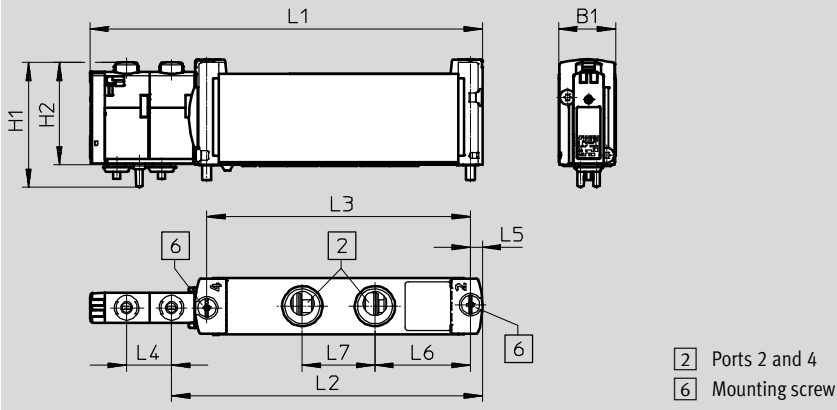

Type	B1	H1	H2	L1	L2	L3	L4	L5	L6	L7
VUVG-S18-...-G14-1T1L	18.7	40.9	33.6	128.6	101.9	86.4	14.7	3.9	31.3	23.8

Ordering data

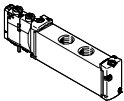
Description		Part No.	Type	
Semi in-line valve G1/4				
	2x 3/2-way valve			
	External pilot air supply	Normally closed	8004873	VUVG-S18-T32C-AZT-G14-1T1L
		Normally open, reset method: pneumatic spring	8004874	VUVG-S18-T32U-AZT-G14-1T1L
		1x normally open, 1x normally closed, reset method: pneumatic spring	8004875	VUVG-S18-T32H-AZT-G14-1T1L
		Normally closed, reset method: mechanical spring	8004876	VUVG-S18-T32C-MZT-G14-1T1L
		Normally open, reset method: mechanical spring	8004877	VUVG-S18-T32U-MZT-G14-1T1L
		1x normally open, 1x normally closed, reset method: mechanical spring	8004878	VUVG-S18-T32H-MZT-G14-1T1L
	5/2-way valve, single solenoid			
	External pilot air supply	Reset method: pneumatic/mechanical spring	8004879	VUVG-S18-M52-RZT-G14-1T1L
		Reset method: mechanical spring	8004880	VUVG-S18-M52-MZT-G14-1T1L
5/2-way valve, double solenoid				
External pilot air supply		8004881	VUVG-S18-B52-ZT-G14-1T1L	
5/3-way valve				
External pilot air supply	Mid-position closed	8004882	VUVG-S18-P53C-ZT-G14-1T1L	
	Mid-position pressurised	8004883	VUVG-S18-P53E-ZT-G14-1T1L	
	Mid-position exhausted	8004884	VUVG-S18-P53U-ZT-G14-1T1L	

Valve terminals VTUG with multi-pin plug and fieldbus connection

FESTO

Order code – Sub-base valves M5/M7

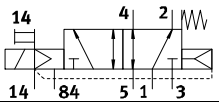
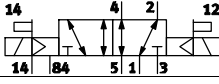
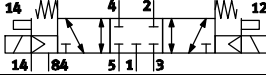
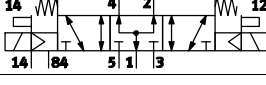
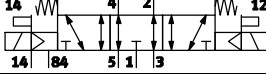
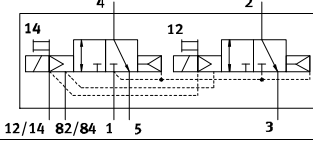
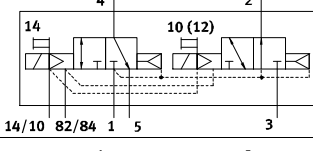
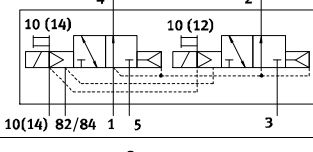
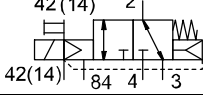
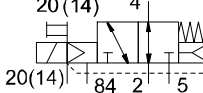
VUVG	-	B	10	-	
Valve design					
Sub-base valves B					
Valve size					
10 mm 10					
10 mm, 3/2-way valve (M32) 10Z					
Valve functions					
					M52
					B52
					P53C
					P53U
					P53E
					T32C
					T32H
					T32U
					M32C
					M32U

Z	-	F	-	1	T1	L
Display						
L LED						
Electrical connection						
T1 Plug-in						
Nominal operating voltage						
1 24 V DC						
Pneumatic connection						
F Flange/sub-base						
Manual override						
H Non-detenting						
S Covered						
T Non-detenting, detenting						
Y Detenting, without accessories						
Pilot air						
Z External						
Reset method						
A Pneumatic spring with T32						
M Mechanical spring with M52 and T32						
R Pneumatic/mechanical spring with M52 and M32						
- With B52 and P53						



Valve terminals VTUG with multi-pin plug and fieldbus connection

Technical data – Sub-base valves M5/M7

Function

- 3/2C, 3/2U
- 2x 3/2C, 2x 3/2U, 2x 3/2H
- 5/2-way, single solenoid
- 5/2-way, double solenoid
- 5/3C, 5/3U, 5/3E

Circuit symbol → Page 13

-  - Valve size 10 mm
-  - Flow rate 130 ... 300 l/min
-  - Voltage 24 V DC



General technical data															
Valve function	T32-A			T32-M			M32-R		M52-R	B52	M52-M	P53			
Normal position	C ¹⁾	U ²⁾	H ⁴⁾	C ¹⁾	U ²⁾	H ⁴⁾	C ¹⁾	U ²⁾	-	-	-	C ¹⁾	U ²⁾	E ³⁾	
Stable position	Monostable									Bistable	Monostable				
Reset method: pneumatic spring	Yes			No			No		Yes ⁵⁾		-	No		-	
Reset method: mechanical spring	No			Yes			Yes		Yes ⁵⁾		-	Yes		-	
Vacuum operation at port 1	No			With external pilot air											
Design	Piston spool														
Sealing principle	Soft														
Actuation type	Electrical														
Type of control	Pilot														
Pilot air supply	External														
Exhaust function	With flow control														
Manual override	Choice of non-detenting, covered, non-detenting/detenting or detenting														
Type of mounting	On manifold rail														
Mounting position	Any														
Switching position display	LED														
Standard nominal flow rate M5/M7	[l/min]	160			140			140		300		260		260	
Flow rate on manifold rail M5, front	[l/min]	150			130			130		220		220		200	
Flow rate on manifold rail M7, front	[l/min]	160			140			140		270		240		250	
Flow rate on manifold rail M7, underneath	[l/min]	160			140			140		300		260		260	
Valve size	[mm]	10													
Port	1, 3, 5, 12/14, 82/84	On manifold rail													
	2, 4	On manifold rail													
Product weight	[g]	59					53			60		53		58	
Certification	c UL us - Recognized (OL)														
	c CSA us (OL)														
	RCM														
CE marking (see declaration of conformity) ⁶⁾	In accordance with EU EMC Directive														
Corrosion resistance class CRC ⁷⁾	2														

1) C=Normally closed/mid-position closed
 2) U=Normally open/mid-position pressurised
 3) E=Mid-position exhausted
 4) H=2x 3/2-way valve in one housing with 1x normally closed and 1x normally open
 5) Combined reset method
 6) For information about the applicability of the component see the manufacturer's EC declaration of conformity at: www.festo.com/sp → Certificates.
 If the component is subject to restrictions on usage in residential, office or commercial environments or small businesses, further measures to reduce the emitted interference may be necessary.
 7) Corrosion resistance class CRC 2 to Festo standard FN 940070
 Moderate corrosion stress. Indoor applications in which condensation may occur. External visible parts with primarily decorative requirements for the surface and which are in direct contact with the ambient atmosphere typical for industrial applications.

Valve terminals VTUG with multi-pin plug and fieldbus connection

FESTO

Technical data – Sub-base valves M5/M7

Operating and environmental conditions									
Valve function			T32-A ¹⁾	T32-M ³⁾	M32-R ²⁾	M52-R ²⁾	B52	M52-M ³⁾	P53
Operating medium		Compressed air to ISO 8573-1:2010 [7:4:4]							
Operating pressure	Internal pilot air supply	[bar]	1.5 ... 8	2.5 ... 8	2.5 ... 8	2.5 ... 8	1.5 ... 8	3 ... 8	3 ... 8
	External pilot air supply	[bar]	1.5 ... 10	-0.9 ... 10				-0.9 ... 8	-0.9 ... 10
Pilot pressure ⁴⁾		[bar]	1.5 ... 8	2 ... 8	2.5 ... 8	2.5 ... 8	1.5 ... 8	3 ... 8	3 ... 8
Ambient temperature		[°C]	-5 ... +60						
Temperature of medium		[°C]	-5 ... +60						

- 1) Pneumatic spring
- 2) Mixed, pneumatic/mechanical spring
- 3) Mechanical spring
- 4) Minimum pilot pressure 50% of operating pressure

Electrical data		
Electrical connection		Via sub-base
Operating voltage	[V DC]	24 ±10%
Power consumption per valve solenoid	[W]	1/0.4 (after 25 ms)
Duty cycle	[%]	100
Max. switching frequency	[Hz]	3
Degree of protection to EN 60529	Individual valve	IP67/IP65
	Valve terminal	IP40, IP67/IP65

Safety data		
Max. positive test pulse with 0 signal	[µs]	1600
Max. negative test pulse with 1 signal	[µs]	3000
Shock resistance	Shock test with severity level 2 to FN 942017-5 and EN 60068-2-27	
Vibration resistance	Transport application test with severity level 2 to FN 942017-4 and EN 60068-2-6	

Information on materials	
Housing	Wrought aluminium alloy
Seals	HNBR, NBR
Note on materials	RoHS compliant

Valve switching times									
Valve function			T32-A ¹⁾	T32-M ³⁾	M32-R ²⁾	M52-R ²⁾	B52	M52-M ³⁾	P53
Switching time on	[ms]	8	10	9	9	-	12	12	
Switching time off	[ms]	20	20	17	21	-	30	38	
Changeover time	[ms]	-	-	-	-	9	-	16	

- 1) Pneumatic spring
- 2) Mixed, pneumatic/mechanical spring
- 3) Mechanical spring

Valve terminals VTUG with multi-pin plug and fieldbus connection

Technical data – Sub-base valves M5/M7

Dimensions

Download CAD data → www.festo.com

Sub-base valve M5/M7

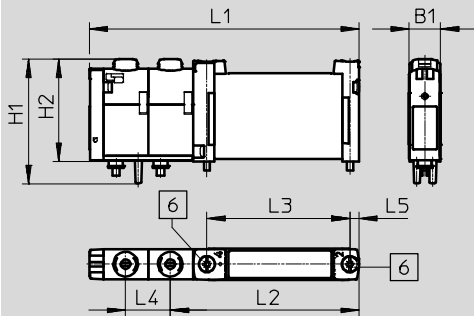

6 Mounting screw

Type	B1	H1	H2	L1	L2	L3	L4	L5
VUVG-B10-...-F-1T1L	10.3	40.7	33.6	88.6	62	47	14.7	3

Ordering data

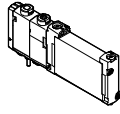
Description	Part No.	Type	
Sub-base valve M5/M7			
	3/2-way valve		
	External pilot air supply	Normally closed, reset method: mechanical spring	8028231 VUVG-B10Z-M32C-RZT-F-1T1L
		Normally open, reset method: mechanical spring	8028232 VUVG-B10Z-M32U-RZT-F-1T1L
	2x 3/2-way valve		
	External pilot air supply	Normally closed, reset method: pneumatic spring	573410 VUVG-B10-T32C-AZT-F-1T1L
		Normally open, reset method: pneumatic spring	573411 VUVG-B10-T32U-AZT-F-1T1L
		1x normally open, 1x normally closed, reset method: pneumatic spring	573412 VUVG-B10-T32H-AZT-F-1T1L
		Normally closed, reset method: mechanical spring	573413 VUVG-B10-T32C-MZT-F-1T1L
		Normally open, reset method: mechanical spring	573414 VUVG-B10-T32U-MZT-F-1T1L
		1x normally open, 1x normally closed, reset method: mechanical spring	573415 VUVG-B10-T32H-MZT-F-1T1L
	5/2-way valve, single solenoid		
	External pilot air supply	Reset method: mechanical spring	573417 VUVG-B10-M52-MZT-F-1T1L
		Reset method: pneumatic/mechanical spring	573416 VUVG-B10-M52-RZT-F-1T1L
	5/2-way valve, double solenoid		
	External pilot air supply		573418 VUVG-B10-B52-ZT-F-1T1L
5/3-way valve			
External pilot air supply	Mid-position closed	573419 VUVG-B10-P53C-ZT-F-1T1L	
	Mid-position pressurised	573421 VUVG-B10-P53U-ZT-F-1T1L	
	Mid-position exhausted	573420 VUVG-B10-P53E-ZT-F-1T1L	

Valve terminals VTUG with multi-pin plug and fieldbus connection

Order code – Sub-base valves G1/8

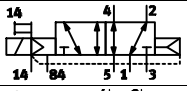
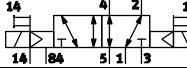
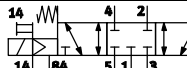
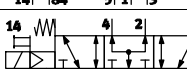
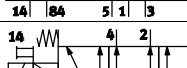
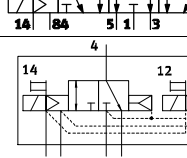
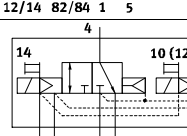
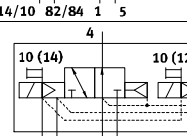
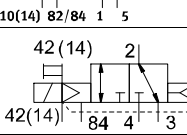
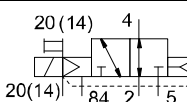
VUVG	-	B	14	-		
Valve design						
Sub-base valves B						
Valve size						
14 mm 14						
14 mm, 3/2-way valve (M32) 14Z						
Valve functions						
						M52
						B52
						P53C
						P53U
						P53E
						T32C
						T32H
						T32U
						M32C
						M32U

Z	-	F	-	1	T1	L
Display						
L LED						
Electrical connection						
T1 Plug-in						
Nominal operating voltage						
1 24 V DC						
Pneumatic connection						
F Flange/sub-base						
Manual override						
H Non-detenting						
S Covered						
T Non-detenting, detenting						
Y Detenting, without accessories						
Pilot air						
Z External						
Reset method						
A Pneumatic spring with M52, M32 and T32						
M Mechanical spring with M52 and T32						
-						
With B52 and P53						

Valve terminals VTUG with multi-pin plug and fieldbus connection

Technical data – Sub-base valves G1/8

Function

3/2C, 3/2U

2x 3/2C, 2x 3/2U, 2x 3/2H

5/2-way, single solenoid

5/2-way, double solenoid

5/3C, 5/3U, 5/3E

Circuit symbol → Page 13

-  - Valve size 14 mm

-  - Flow rate
350 ... 560 l/min

-  - Voltage
24 V DC



General technical data														
Valve function	T32-A			T32-M			M32-A		M52-A	B52	M52-M	P53		
Normal position	C ¹⁾	U ²⁾	H ⁴⁾	C ¹⁾	U ²⁾	H ⁴⁾	C ¹⁾	U ²⁾	-	-	-	C ¹⁾	U ²⁾	E ³⁾
Stable position	Monostable									Bistable	Monostable			
Reset method: pneumatic spring	Yes			No			Yes		Yes	-	No	-		
Reset method: mechanical spring	No			Yes			No		No	-	Yes	-		
Vacuum operation at port 1	No			With external pilot air										
Design	Piston spool													
Sealing principle	Soft													
Actuation type	Electrical													
Type of control	Pilot													
Pilot air supply	External													
Exhaust function	With flow control													
Manual override	Choice of non-detenting, covered, non-detenting/detenting or detenting													
Type of mounting	On manifold rail													
Mounting position	Any													
Switching position display	LED													
Standard nominal flow rate G1/8	[l/min]	530			470			350		550	560	550	510	
Flow rate on manifold rail G1/8, front	[l/min]	490			440			320		500	510	500	470	
Flow rate on manifold rail G1/8, underneath	[l/min]	530			470			350		550	560	550	510	
Valve size	[mm]	14												
Port	1, 3, 5, 12/14, 82/84	On manifold rail												
	2, 4	On manifold rail												
Product weight	[g]	102			100			91		98	89	95		
Certification	c UL us - Recognized (OL)													
	c CSA us (OL)													
	RCM													
CE marking (see declaration of conformity) ⁵⁾	In accordance with EU EMC Directive													
Corrosion resistance class CRC ⁶⁾	2													

1) C=Normally closed/mid-position closed

2) U=Normally open/mid-position pressurised

3) E=Mid-position exhausted

4) H=2x 3/2-way valve in one housing with 1x normally closed and 1x normally open

5) For information about the applicability of the component see the manufacturer's EC declaration of conformity at: www.festo.com/sp → Certificates.

If the component is subject to restrictions on usage in residential, office or commercial environments or small businesses, further measures to reduce the emitted interference may be necessary.

6) Corrosion resistance class CRC 2 to Festo standard FN 940070

Moderate corrosion stress. Indoor applications in which condensation may occur. External visible parts with primarily decorative requirements for the surface and which are in direct contact with the ambient atmosphere typical for industrial applications.

Valve terminals VTUG with multi-pin plug and fieldbus connection

FESTO

Technical data – Sub-base valves G1/8

Operating and environmental conditions									
Valve function			T32-A ¹⁾	T32-M ²⁾	M32-A ¹⁾	M52-A ¹⁾	B52	M52-M ²⁾	P53
Operating medium		Compressed air to ISO 8573-1:2010 [7:4:4]							
Operating pressure	Internal pilot air supply	[bar]	1.5 ... 8	3.5 ... 8	2.5 ... 8	2.5 ... 8	1.5 ... 8	3 ... 8	3 ... 8
	External pilot air supply	[bar]	1.5 ... 10	-0.9 ... 10				-0.9 ... 8	-0.9 ... 10
Pilot pressure ³⁾		[bar]	1.5 ... 8	2 ... 8	2.5 ... 8	2.5 ... 8	1.5 ... 8	3 ... 8	3 ... 8
Ambient temperature		[°C]	-5 ... +60						
Temperature of medium		[°C]	-5 ... +60						

1) Pneumatic spring

2) Mechanical spring

3) Minimum pilot pressure 50% of operating pressure

Electrical data		
Electrical connection		Via sub-base
Operating voltage	[V DC]	24 ±10%
Power	[W]	1/0.4 (after 25 ms)
Duty cycle	[%]	100
Max. switching frequency	[Hz]	3
Degree of protection to EN 60529	Individual valve	IP67/IP65
	Valve terminal	IP40, IP67/IP65

Safety data		
Max. positive test pulse with 0 signal	[µs]	1600
Max. negative test pulse with 1 signal	[µs]	3000
Shock resistance	Shock test with severity level 2 to FN 942017-5 and EN 60068-2-27	
Vibration resistance	Transport application test with severity level 2 to FN 942017-4 and EN 60068-2-6	

Information on materials	
Housing	Wrought aluminium alloy
Seals	HNBR, NBR
Note on materials	RoHS compliant

Valve switching times									
Valve function			T32-A ¹⁾	T32-M ²⁾	M32-A ¹⁾	M52-A ¹⁾	B52	M52-M ²⁾	P53
Switching time on	[ms]	10	13	13	13	-	10	15	
Switching time off	[ms]	29	21	20	26	-	38	42	
Changeover time	[ms]	-	-	-	-	9	-	25	

1) Pneumatic spring

2) Mechanical spring

Valve terminals VTUG with multi-pin plug and fieldbus connection

Technical data – Sub-base valves G1/8

Dimensions

Download CAD data → www.festo.com

Sub-base valve G1/8

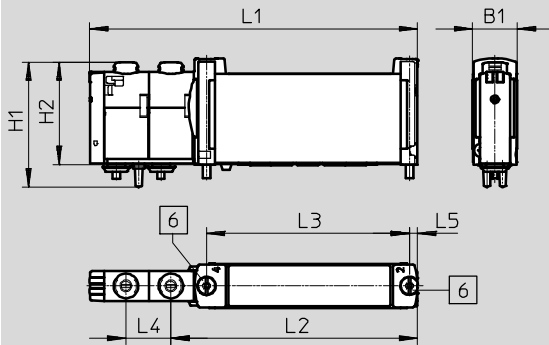

6 Mounting screw

Type	B1	H1	H2	L1	L2	L3	L4	L5
VUVG-B14-...-F-1T1L	14.7	40.9	33.5	107.6	81	66.5	14.7	2.8

Ordering data

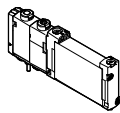
Description	Part No.	Type	
Sub-base valve G1/8			
	3/2-way valve		
	External pilot air supply	Normally closed, reset method: pneumatic spring	8028235 VUVG-B14Z-M32C-AZT-F-1T1L
		Normally open, reset method: pneumatic spring	8028236 VUVG-B14Z-M32U-AZT-F-1T1L
	2x 3/2-way valve		
	External pilot air supply	Normally closed, reset method: pneumatic spring	573476 VUVG-B14-T32C-AZT-F-1T1L
		Normally open, reset method: pneumatic spring	573477 VUVG-B14-T32U-AZT-F-1T1L
		1x normally open, 1x normally closed, reset method: pneumatic spring	573478 VUVG-B14-T32H-AZT-F-1T1L
		Normally closed, reset method: mechanical spring	573479 VUVG-B14-T32C-MZT-F-1T1L
		Normally open, reset method: mechanical spring	573480 VUVG-B14-T32U-MZT-F-1T1L
		1x normally open, 1x normally closed, reset method: mechanical spring	573481 VUVG-B14-T32H-MZT-F-1T1L
	5/2-way valve, single solenoid		
	External pilot air supply	Reset method: pneumatic spring	573482 VUVG-B14-M52-AZT-F-1T1L
		Reset method: mechanical spring	573483 VUVG-B14-M52-MZT-F-1T1L
	5/2-way valve, double solenoid		
	External pilot air supply		573484 VUVG-B14-B52-ZT-F-1T1L
5/3-way valve			
External pilot air supply	Mid-position closed	573485 VUVG-B14-P53C-ZT-F-1T1L	
	Mid-position pressurised	573487 VUVG-B14-P53U-ZT-F-1T1L	
	Mid-position exhausted	573486 VUVG-B14-P53E-ZT-F-1T1L	

Valve terminals VTUG with multi-pin plug and fieldbus connection

FESTO

Order code – Sub-base valves G1/4

VUVG	-	B	18	-	
Valve design					
Sub-base valves B					
Valve size					
18 mm 18					
Valve functions					
					M52
					B52
					P53C
					P53U
					P53E
					T32C
					T32H
					T32U

	Z	-	F	-	1	T1	L
Display							
L LED							
Electrical connection							
T1 Plug-in							
Nominal operating voltage							
1 24 V DC							
Pneumatic connection							
F Flange/sub-base							
Manual override							
H Non-detenting							
S Covered							
T Non-detenting, detenting							
Y Detenting, without accessories							
Pilot air							
Z External							
Reset method							
A Pneumatic spring with T32							
M Mechanical spring with M52 and T32							
R Pneumatic/mechanical spring with M52							
- With B52 and P53							



Valve terminals VTUG with multi-pin plug and fieldbus connection

Technical data – Sub-base valves G1/4

Function

2x 3/2C, 2x 3/2U, 2x 3/2H
 5/2-way, single solenoid
 5/2-way, double solenoid
 5/3C, 5/3U, 5/3E

Circuit symbol → Page 13

-  - Valve size 18 mm
-  - Flow rate 800 ... 1000 l/min
-  - Voltage 24 V DC

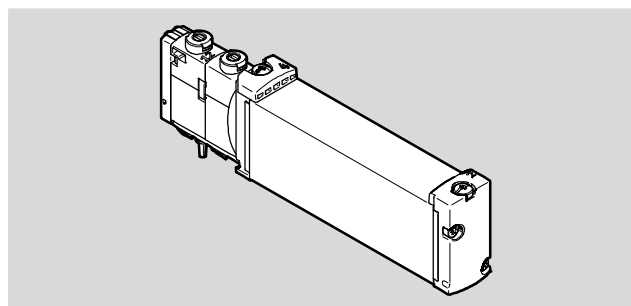

General technical data												
Valve function	T32-A			T32-M			M52-R	B52	M52-M	P53		
Normal position	C ¹⁾	U ²⁾	H ⁴⁾	C ¹⁾	U ²⁾	H ⁴⁾	–	–	–	C ¹⁾	U ²⁾	E ³⁾
Stable position	Monostable							Bistable	Monostable			
Reset method: pneumatic spring	Yes			No			Yes ⁵⁾	–	No	–		
Reset method: mechanical spring	No			Yes			Yes ⁵⁾	–	Yes	–		
Vacuum operation at port 1	No			With external pilot air								
Design	Piston spool											
Sealing principle	Soft											
Actuation type	Electrical											
Type of control	Pilot											
Pilot air supply	External											
Exhaust function	With flow control											
Manual override	Choice of non-detenting, covered, non-detenting/detenting or detenting											
Type of mounting	On manifold rail											
Mounting position	Any											
Switching position display	LED											
Flow rate on manifold rail G ¹ / ₄ , front	[l/min]	800		800		950	1000	950	900			
Valve size	[mm]	18										
Port	1, 3, 5, 12/14, 82/84	On manifold rail										
	2, 4	On manifold rail										
Product weight	[g]	145		147		138	145	138	140			
Certification	c UL us - Recognized (OL)											
	c CSA us (OL)											
	RCM											
CE marking (see declaration of atmosphere)	To EU EMC Directive ⁶⁾											
Corrosion resistance class CRC ⁷⁾	2											

1) C=Normally closed/mid-position closed
 2) U=Normally open/mid-position pressurised
 3) E=Mid-position exhausted
 4) H=2x 3/2-way valve in one housing with 1x normally closed and 1x normally open
 5) Combined reset method
 6) For information about the applicability of the component see the manufacturer's EC declaration of conformity at: www.festo.com/sp → Certificates.
 If the component is subject to restrictions on usage in residential, office or commercial environments or small businesses, further measures to reduce the emitted interference may be necessary.
 7) Corrosion resistance class CRC 2 to Festo standard FN 940070
 Moderate corrosion stress. Indoor applications in which condensation may occur. External visible parts with primarily decorative requirements for the surface and which are in direct contact with the ambient atmosphere typical for industrial applications.

Valve terminals VTUG with multi-pin plug and fieldbus connection

FESTO

Technical data – Sub-base valves G1/4

Operating and environmental conditions							
Valve function		T32-A ¹⁾	T32-M ²⁾	M52-R ³⁾	B52	M52-M ²⁾	P53
Operating medium		Compressed air to ISO 8573-1:2010 [7:4:4]					
Pilot medium		Compressed air to ISO 8573-1:2010 [7:4:4]					
Note on operating/pilot medium		Lubricated operation possible (in which case lubricated operation will always be required)					
Operating pressure	Internal pilot air supply [bar]	1.5 ... 8	2 ... 8	2.5 ... 8	1.5 ... 8	3 ... 8	3 ... 8
	External pilot air supply [bar]	1.5 ... 10	-0.9 ... 10				-0.9 ... 8
Pilot pressure ⁴⁾	[bar]	1.5 ... 8	2 ... 8	2.5 ... 8	1.5 ... 8	3 ... 8	3 ... 8
Ambient temperature	[°C]	-5 ... +60					
Temperature of medium	[°C]	-5 ... +60					

- 1) Pneumatic spring
- 2) Mechanical spring
- 3) Mixed, pneumatic/mechanical spring
- 4) Minimum pilot pressure 50% of operating pressure

Electrical data		
Electrical connection		Via sub-base
Operating voltage	[V DC]	24 ±10%
Power	[W]	1
Duty cycle	[%]	100
Max. switching frequency	[Hz]	3
Degree of protection to EN 60529	Individual valve	IP67/IP65
	Valve terminal	IP40, IP67/IP65

Safety data		
Max. positive test pulse with 0 signal	[µs]	1600
Max. negative test pulse with 1 signal	[µs]	3000
Shock resistance		Shock test with severity level 2 to FN 942017-5 and EN 60068-2-27
Vibration resistance		Transport application test with severity level 2 to FN 942017-4 and EN 60068-2-6

Information on materials	
Housing	Wrought aluminium alloy
Seals	HNBR, NBR
Note on materials	RoHS compliant

Valve switching times							
Valve function		T32-A ¹⁾	T32-M ²⁾	M52-R ³⁾	B52	M52-M ²⁾	P53
Switching time on	[ms]	15	25	20	–	13	20
Switching time off	[ms]	35	33	35	–	50	57
Changeover time	[ms]	–	–	–	15	–	31

- 1) Pneumatic spring
- 2) Mechanical spring
- 3) Mixed, pneumatic/mechanical spring

Valve terminals VTUG with multi-pin plug and fieldbus connection

Technical data – Sub-base valves G1/4

Dimensions

Download CAD data → www.festo.com

Sub-base valve G1/4

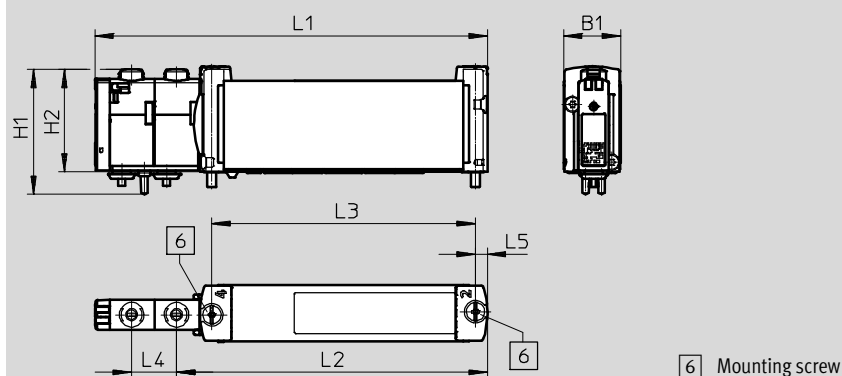

Type	B1	H1	H2	L1	L2	L3	L4	L5
VUVG-B18-...-F-1T1L	18.7	40.9	33.6	128.6	101.9	86.4	14.7	3.9

Ordering data

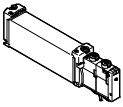
Description	Part No.	Type
Sub-base valve G1/4		
 2x 3/2-way valve External pilot air supply	Normally closed, reset method: pneumatic spring	8004885 VUVG-B18-T32C-AZT-F-1T1L
	Normally open, reset method: pneumatic spring	8004886 VUVG-B18-T32U-AZT-F-1T1L
	1x normally open, 1x normally closed, reset method: pneumatic spring	8004887 VUVG-B18-T32H-AZT-F-1T1L
	Normally closed, reset method: mechanical spring	8004888 VUVG-B18-T32C-MZT-F-1T1L
	Normally open, reset method: mechanical spring	8004889 VUVG-B18-T32U-MZT-F-1T1L
	1x normally open, 1x normally closed, reset method: mechanical spring	8004890 VUVG-B18-T32H-MZT-F-1T1L
5/2-way valve, single solenoid		
External pilot air supply	Reset method: pneumatic/mechanical spring	8004891 VUVG-B18-M52-RZT-F-1T1L
	Reset method: mechanical spring	8004892 VUVG-B18-M52-MZT-F-1T1L
5/2-way valve, double solenoid		
External pilot air supply		8004893 VUVG-B18-B52-ZT-F-1T1L
5/3-way valve		
External pilot air supply	Mid-position closed	8004894 VUVG-B18-P53C-ZT-F-1T1L
	Mid-position exhausted	8004895 VUVG-B18-P53E-ZT-F-1T1L
	Mid-position pressurised	8004896 VUVG-B18-P53U-ZT-F-1T1L

Valve terminals VTUG with multi-pin plug and fieldbus connection

Order code – Manifold rail

VABM	-	L1	-						
Designation									
Manifold rail		L1							
Size									
For valve size 10 mm								10	
For valve size 14 mm								14	
For valve size 18 mm								18	
Version									
Standard								-	
High flow rate								H	
Connection type									
Semi in-line									G
Sub-base									W
Connection direction									
At the side									-
Underneath									B
Front, control cabinet, single feed									S1
Front, control cabinet, double feed									S2
Pneumatic connection 1, 3 and 5									
G1/8 thread									G18
G1/4 thread									G14
G3/8 thread									G38

	-		-						
Additional function									
									- None
									LC Interlock
Outlet direction of electrical components									
									- Top
									L Left
Circuitry									
									- None
									R Holding current reduction with protective circuit
Electrical connection									
									- None
									G Preparation for electrical connection
									LK IO-Link
									M1 Multi-pin with SUB-D plug connector
									M3 Multi-pin with flat cable
									PT I-Port interface
Port for valve function									
									- All valve positions can be fitted with 2 valve coils
									M Not all valve positions can be fitted with 2 valve coils

Valve positions	
4	4 valve positions
5	5 valve positions
6	6 valve positions
7	7 valve positions
8	8 valve positions
9	9 valve positions
10	10 valve positions
12	12 valve positions
16	16 valve positions
20	20 valve positions
24	24 valve positions

Valve terminals VTUG with multi-pin plug and fieldbus connection



Technical data – Manifold rail VABM

General technical data				
Manifold rail		Size 10	Size 14	Size 18
Short type code		VABM		
Grid dimension	[mm]	10.5	16	19
Mounting position		Any		
Connection type		Semi in-line/sub-base		
Max. no. of valve positions		24		
Port	12/14	M5	M5	G1/8
	82/84	M5	M5	G1/8
	2, 4	M5 or M7	G1/8	G1/4
	1, 3, 5	G1/8	G1/4	G3/8
Storage temperature	[°C]	-20 ... 60		
Certification		c UL us - Recognized (OL)		
		c CSA us (OL)		
CE mark (see declaration of conformity) ¹⁾		In accordance with EU EMC Directive		
Corrosion resistance class CRC ²⁾		2		

1) For information about the applicability of the component see the manufacturer's EC declaration of conformity at: www.festo.com/sp → Certificates.

If the component is subject to restrictions on usage in residential, office or commercial environments or small businesses, further measures to reduce the emitted interference may be necessary.

2) Corrosion resistance class CRC 2 to Festo standard FN 940070

Moderate corrosion stress. Indoor applications in which condensation may occur. External visible parts with primarily decorative requirements for the surface and which are in direct contact with the ambient atmosphere typical for industrial applications.

Weight [g]											
valve positions	4	5	6	7	8	9	10	12	16	20	24
VABM-L1-10G-G18-...	329	363	397	431	465	499	533	601	737	873	1009
VABM-L1-10HW-G18-...	388	426	464	502	540	578	616	692	844	996	1148
VABM-L1-14G-G14-...	879	990	1101	1212	1323	1434	1545	1767	2211	2655	3099
VABM-L1-14W-G14-...	839	940	1041	1142	1243	1344	1445	1647	2051	2455	2859
VABM-L1-18G-G38-...	1461	1661	1861	2061	2261	2461	2661	3061	3861	4661	5461
VABM-L1-18W-G38-...	1369	1546	1723	1900	2077	2254	2431	2785	3493	4201	4909

Materials	
Manifold rail	Wrought aluminium alloy
Note on materials	RoHS compliant

Valve terminals VTUG with multi-pin plug and fieldbus connection

Technical data – Manifold rail VABM

Dimensions – Example of a valve terminal with I-Port interface

Download CAD data → www.festo.com

Outlet direction of electrical components on top

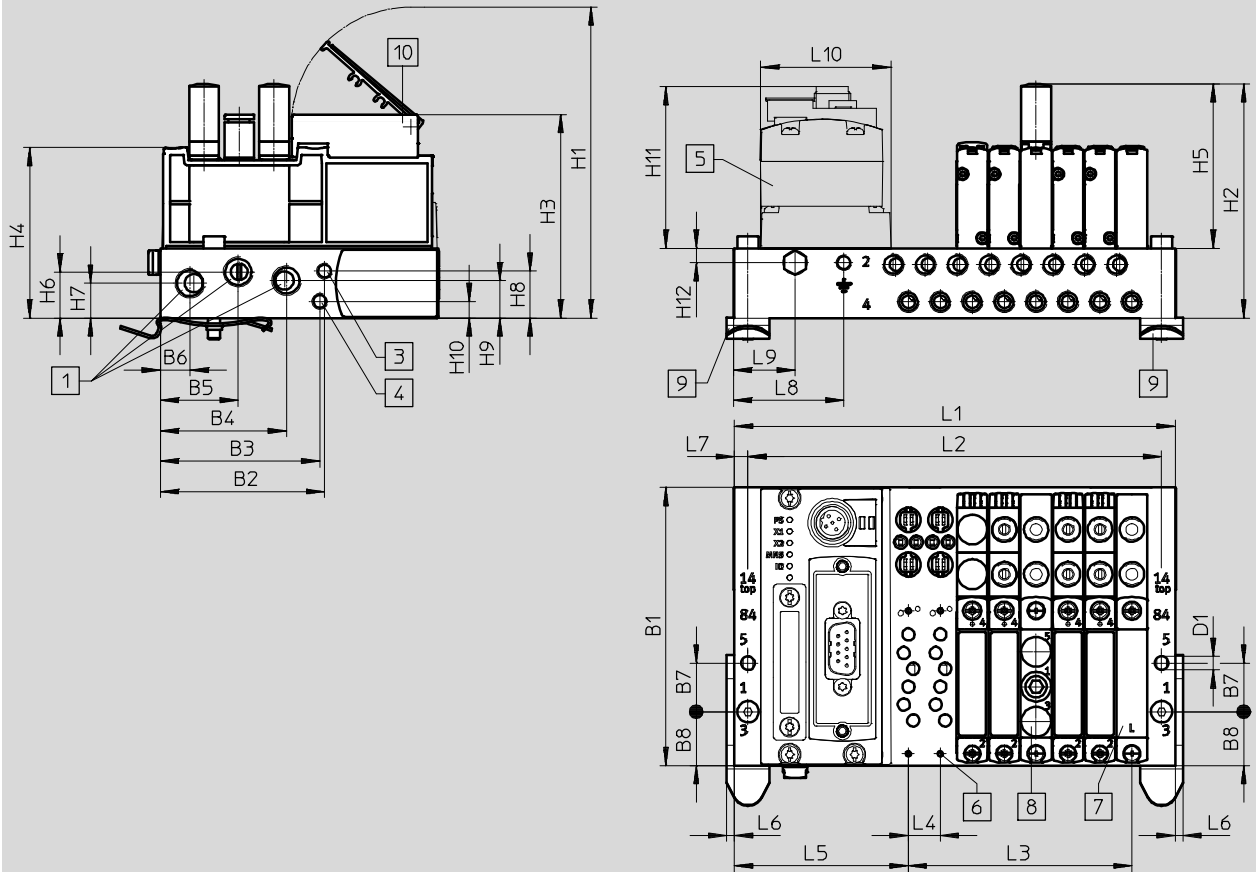

- 1 Port 1, 3 and 5
- 2 Port 12/14
- 3 Port 82/84
- 4 CTEU CANopen
- 5 Valves/blanking plates/supply plates – mounting on manifold block
- 6 Blanking plate
- 7 Supply plate, ports 1, 3 and 5
- 8 H-rail mounting
- 9 Inscription label holder
- 10

Type	No. of valve positions	Size 10																
		B1	B2	B3	B4	B5	B6	B7	B8	D1 Ø	H1	H2	H3	H4	H5	H6	H7	H8
VABM	4-24	91.5	54	52.4	41.5	25.6	9.8	16	17.7	4.5	102.3	77.1	67	56.1	54.1	15.2	11.5	15.5

Type	No. of valve positions	Size 10										
		H9	H10	H11	H12	L4	L5	L6	L7	L8	L9	L10
VABM	4-24	12.4	5.5	54.8	4.8	10.5	57.3	2.5	4.5	36	20	42.5

Type	No. of valve positions	Size 14																
		B1	B2	B3	B4	B5	B6	B7	B8	D1 Ø	H1	H2	H3	H4	H5	H6	H7	H8
VABM	4-24	110	70	59.3	56.5	36.5	16	20	26.5	4.5	113.1	95.1	77.7	68.6	61.3	18.7	15.7	28.7

Valve terminals VTUG with multi-pin plug and fieldbus connection

FESTO

Technical data – Manifold rail VABM

Type	No. of valve positions	Size 14										
		H9	H10	H11	H12	L4	L5	L6	L7	L8	L9	L10
VABM	4-24	13.2	23.7	54.8	5.1	16	60.6	2	5	10	25.5	42.5

Type	No. of valve positions	Size 18																
		B1	B2	B3	B4	B5	B6	B7	B8	D1 Ø	H1	H2	H3	H4	H5	H6	H7	H8
VABM	4-24	131	90.5	77.3	72.3	47.5	21.5	26	34	5.5	121.5	95.2	-	77.4	52.7	23.6	18.7	35.1

Type	No. of valve positions	Size 18										
		H9	H10	H11	H12	L4	L5	L6	L7	L8	L9	L10
VABM	4-24	14.5	27	54.8	13.8	19	63.5	2	5	10	27	42.5

Type	No. of valve positions	Size 10			Size 14			Size 18		
		L1	L2	L3	L1	L2	L3	L1	L2	L3
VABM	4	103	94	31.5	128	118	48	139.5	129.5	57
	5	113.5	104.5	42	144	134	64	158.5	148.5	76
	6	124	115	52.5	160	150	80	177.5	167.5	95
	7	134.5	125.5	63	176	166	96	196.5	186.5	114
	8	145	136	73.5	192	182	112	215.5	205.5	133
	9	155.5	146.5	84	208	198	128	234.5	224.5	152
	10	166	157	94.5	224	214	144	253.5	243.5	171
	12	187	178	115.5	256	246	176	291.5	281.5	209
	16	229	220	157.5	320	310	240	367.5	357.5	285
20	271	262	199.5	384	374	304	443.5	433.5	361	
24	313	304	241.5	448	438	368	519.5	509.5	437	

Valve terminals VTUG with multi-pin plug and fieldbus connection

Technical data – Manifold rail VABM

Dimensions – Example of a valve terminal with I-Port interface

Download CAD data → www.festo.com

Outlet direction of electrical components to the left

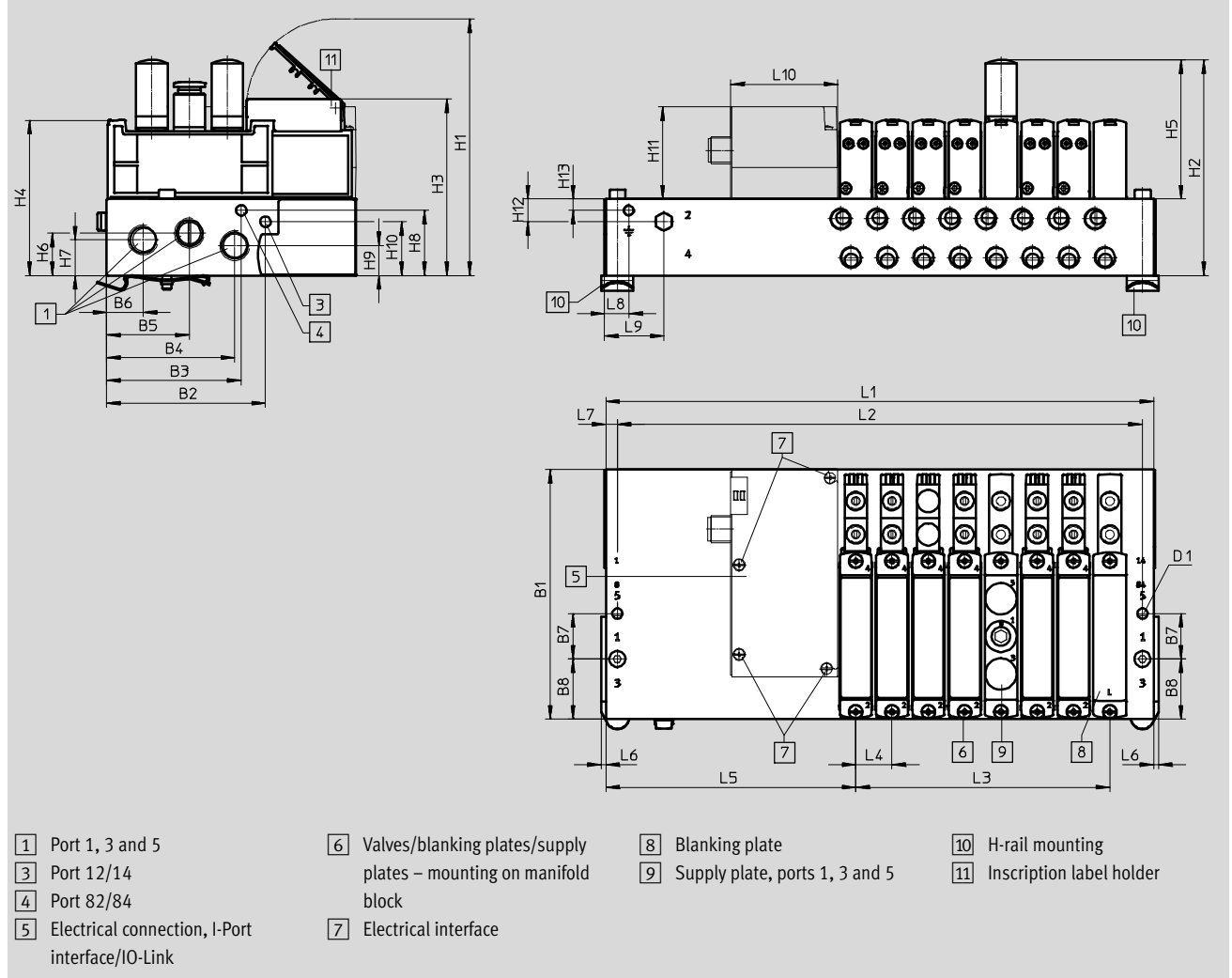

Type	No. of valve positions	Size 10																
		B1	B2	B3	B4	B5	B6	B7	B8	D1∅	H1	H2	H3	H4	H5	H6	H7	H8
VABM	4-24	91.5	54	52.4	41.5	25.6	9.8	16	17.7	4.5	102.3	77.1	67	56.1	54.1	15.2	11.5	15.5

Type	No. of valve positions	Size 10												
		H9	H10	H11	H12	H13	L4	L5	L6	L7	L8	L9	L10	
VABM	4-24	12.4	5.5	40.8	10.1	5.1	10.5	106.8	2.5	4.5	36	75	47.1	

Type	No. of valve positions	Size 14																
		B1	B2	B3	B4	B5	B6	B7	B8	D1 ∅	H1	H2	H3	H4	H5	H6	H7	H8
VABM	4-24	110	70	59.3	56.5	36.5	16	20	26.5	4.5	113.1	95.1	77.7	68.6	61.3	18.7	15.7	28.7

Type	No. of valve positions	Size 14												
		H9	H10	H11	H12	H13	L4	L5	L6	L7	L8	L9	L10	
VABM	4-24	13.2	23.7	40.8	10.1	5.1	16	110.1	2	5	10	75	47.1	

Valve terminals VTUG with multi-pin plug and fieldbus connection

Technical data – Manifold rail VABM

Type	No. of valve positions	Size 18																
		B1	B2	B3	B4	B5	B6	B7	B8	D1 Ø	H1	H2	H3	H4	H5	H6	H7	H8
VABM	4-24	131	90.5	77.3	72.3	47.5	21.5	26	34	5.5	121.5	95.2	-	77.4	52.7	23.6	18.7	35.1

Type	No. of valve positions	Size 18											
		H9	H10	H11	H12	H13	L4	L5	L6	L7	L8	L9	L10
VABM	4-24	14.5	27	40.8	13.8	10	19	105	2	5	10	27	47.1

Type	No. of valve positions	Size 10			Size 14			Size 18		
		L1	L2	L3	L1	L2	L3	L1	L2	L3
VABM	4	152.5	143.5	31.5	177.5	167.5	48	181	171	57
	5	163	154	42	193.5	183.5	64	200	190	76
	6	173.5	164.5	52.5	209.5	199.5	80	219	209	95
	7	184	175	63	225.5	215.5	96	238	228	114
	8	194.5	185.5	73.5	241.5	231.5	112	257	247	133
	9	205	196	84	257.5	247.5	128	276	266	152
	10	215.5	206.5	94.5	273.5	263.5	144	295	285	171
	12	236.5	227.5	115.5	305.5	295.5	176	333	323	209
	16	278.5	269.5	157.5	369.5	359.5	240	409	399	285
	20	321	311.5	199.5	433.5	423.5	304	485	475	361
24	362.5	353.5	241.5	497.5	487.5	368	561	551	437	

 - Note
 The dimensions for size 10 are the same as the dimensions for the manifold rail with interlock.

Valve terminals VTUG with multi-pin plug and fieldbus connection

Technical data – Manifold rail VABM

Dimensions – Example of control cabinet installation for valve terminal

Download CAD data → www.festo.com

Outlet direction of electrical components on top

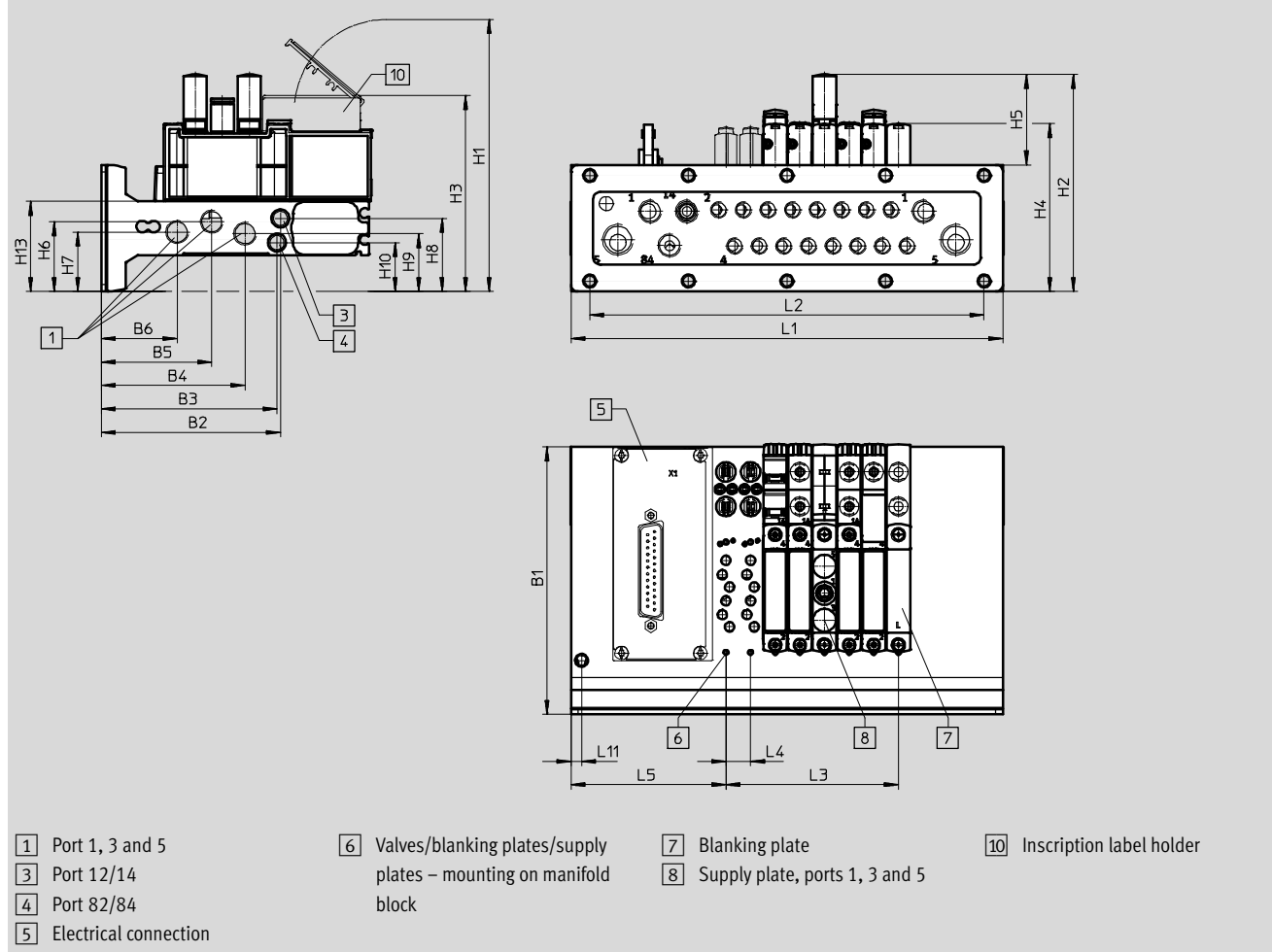

Type	No. of valve positions	Size 10									
		B1	B2	B3	B4	B5	B6	H1	H2	H3	H4
VABM	4-24	114	76.4	74.9	61.3	47.1	32.4	116	92.6	84	71.6

Type	No. of valve positions	Size 10									
		H5	H6	H7	H8	H9	H10	H13	L4	L5	L11
VABM	4-24	38.6	29.8	25.4	31.2	24.7	20.9	38.5	10.5	66	4.5

Type	No. of valve positions	Size 14									
		B1	B2	B3	B4	B5	B6	H1	H2	H3	H4
VABM	4-24	132	93	80.8	76.5	55.5	36.1	111.3	101.7	77.6	85.1

Type	No. of valve positions	Size 14									
		H5	H6	H7	H8	H9	H10	H13	L4	L5	L11
VABM	4-24	34.9	35.2	30.3	39.3	30.3	45	50.3	16	72.6	4.5

Valve terminals VTUG with multi-pin plug and fieldbus connection

Technical data – Manifold rail VABM

No. of valve positions	L1	L2	L3
VABM-L1-10HWS1-G18-4-GR	116.2	84	31.5
VABM-L1-10HWS1-G18-8-GR	158.2	126	73.5
VABM-L1-10HWS2-G18-8-GR	184	168	73.5
VABM-L1-10HWS2-G18-12-GR	226	210	115.5
VABM-L1-10HWS2-G18-16-GR	268	252	157.5
VABM-L1-10HWS2-G18-24-GR	352	336	241.5
VABM-L1-14HWS1-G14-4-GR	135	64	48
VABM-L1-14HWS1-G14-8-GR	199	128	112
VABM-L1-14HWS2-G14-8-GR	234	192	112
VABM-L1-14HWS2-G14-12-GR	298	256	176
VABM-L1-14HWS2-G14-16-GR	362	320	240
VABM-L1-14HWS2-G14-24-GR	490	448	368

Dimensions – Manifold rail outlet direction to the front

Download CAD data → www.festo.com

Size 10, I-Port interface on top

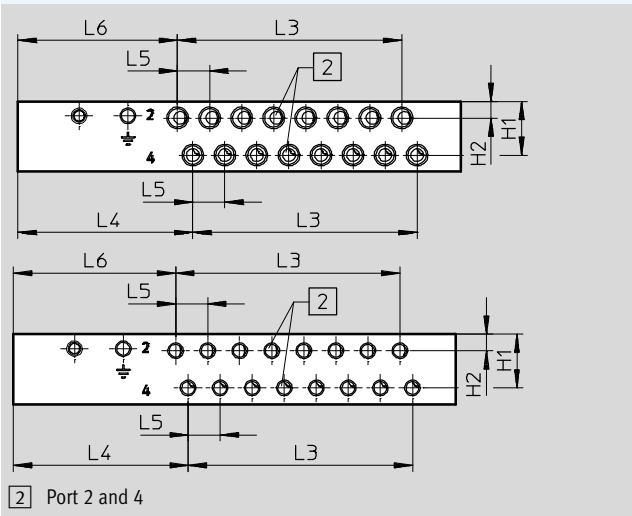

Size 14, I-Port interface on top

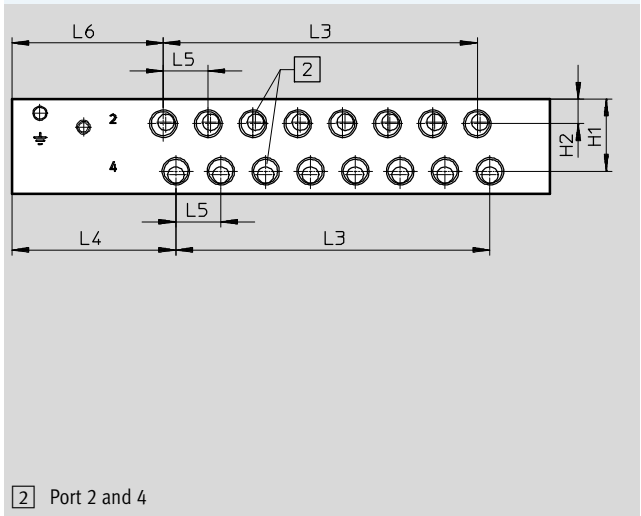

Size 18, I-Port interface on top

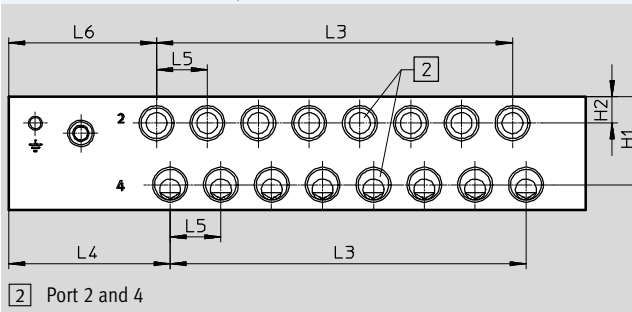

Size 10, 14, 18, I-Port interface on the side

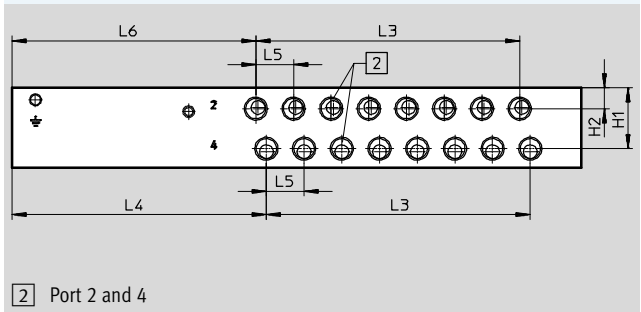

Size	Port 2 and 4	Manifold rail with I-Port interface on top				
		H1	H2	L4	L5	L6
10	M7 thread	17.6	5.4	57.3	10.5	52.3
	M5 thread					53.2
14	G1/8 thread	25.8	8.8	58.5	16	54
18	G1/4 thread	33	10	60.3	19	55.3

Valve terminals VTUG with multi-pin plug and fieldbus connection



Technical data – Manifold rail VABM

Size	Port 2 and 4	Manifold rail with I-Port interface on the side				
		H1	H2	L4	L5	L6
10	M7 thread	17.6	5.4	106.8	10.5	101.8
	M5 thread					102.7
14	G1/8 thread	25.8	8.8	108	16	103.5
18	G1/4 thread	33	10	101.8	19	96.8

Type	No. of valve positions	Size 10	Size 14	Size 18
		L3	L3	L3
VABM	4	31.5	48	57
	5	42	64	76
	6	52.5	80	95
	7	63	96	114
	8	73.5	112	133
	9	84	128	152
	10	94.5	144	171
	12	115.5	176	209
	16	157.5	240	285
	20	199.5	304	361
	24	241.5	368	437

Valve terminals VTUG with multi-pin plug and fieldbus connection

Technical data – Manifold rail VABM

Dimensions – Manifold rail outlet direction underneath

Download CAD data → www.festo.com

Control cabinet installation

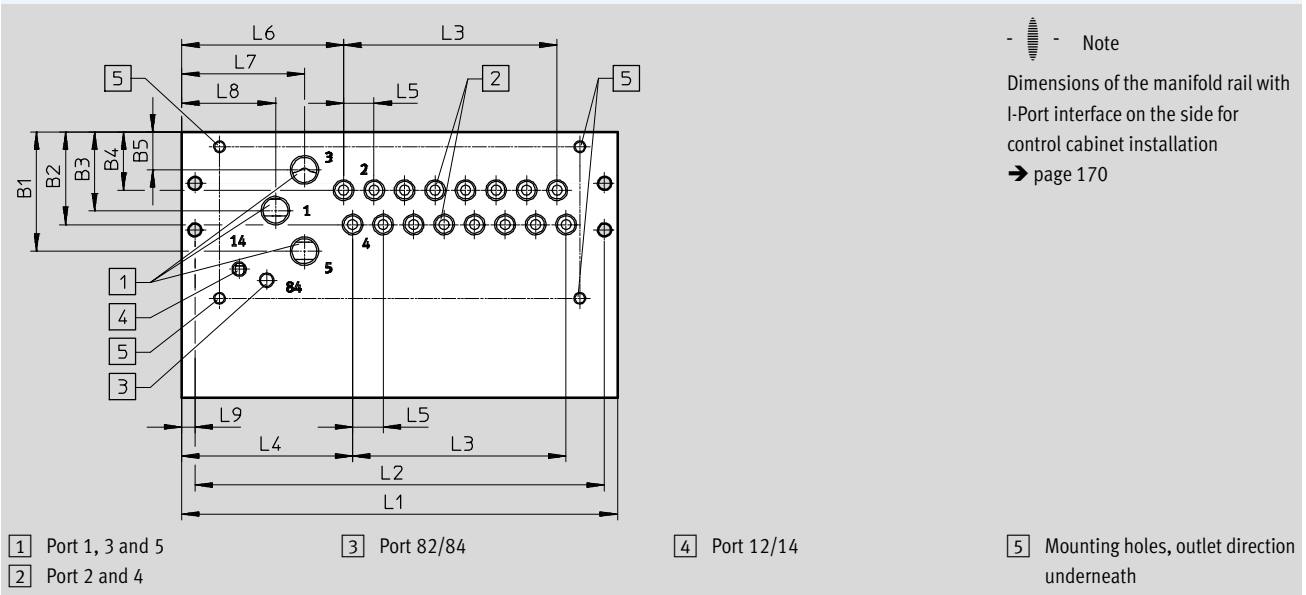

Type	Manifold rail with I-Port interface on top, size 10										
	B1	B2	B3	B4	B5	L4	L5	L6	L7	L8	L9
VABM	41	31.8	27	20	13	58.8	10.5	55.7	42.3	32.3	4.5

Type	Manifold rail with I-Port interface on top, size 14										
	B1	B2	B3	B4	B5	L4	L5	L6	L7	L8	L9
VABM	53.5	45.1	35.2	27.8	17	58.5	16	58.5	43	33	5

Type	Manifold rail with I-Port interface on top, size 18										
	B1	B2	B3	B4	B5	L4	L5	L6	L7	L8	L9
VABM	75	59.5	48.5	35.7	22	60.3	19	60.3	40	40	5

Type	No. of valve positions	Size 10			Size 14			Size 18		
		L1 +5	L2 +5	L3	L1	L2	L3	L1	L2	L3
VABM	4	103	94	31.5	128	118	48	139.5	129.5	57
	5	113.5	104.5	42	144	134	64	158.5	148.5	76
	6	124	115	52.5	160	150	80	177.5	167.5	95
	7	134.5	125.5	63	176	166	96	196.5	186.5	114
	8	145	136	73.5	192	182	112	215.5	205.5	133
	9	155.5	146.5	84	208	198	128	234.5	224.5	152
	10	166	157	94.5	224	214	144	253.5	243.5	171
	12	187	178	115.5	256	246	176	291.5	281.5	209
	16	229	220	157.5	320	310	240	367.5	357.5	285
	20	271	262	199.5	384	374	304	443.5	433.5	361
24	313	304	241.5	448	438	368	519.5	509.5	437	

Valve terminals VTUG with multi-pin plug and fieldbus connection



Technical data – Manifold rail VABM

Type	Manifold rail with I-Port interface, size 10										
	B1	B2	B3	B4	B5	L4	L5	L6	L7	L8	L9
VABM	41	31.8	27	20	13	108.3	10.5	105.2	91.8	81.8	4.5

Type	Manifold rail with I-Port interface, size 14										
	B1	B2	B3	B4	B5	L4	L5	L6	L7	L8	L9
VABM	53.5	45.1	35.2	27.8	17	108	16	108	92.5	82.5	5

Type	Manifold rail with I-Port interface, size 18										
	B1	B2	B3	B4	B5	L4	L5	L6	L7	L8	L9
VABM	75	59.5	48.5	35.7	22	101.8	19	101.8	81.5	81.5	5

Type	No. of valve positions	Manifold rail with I-Port interface Size 10			Manifold rail with I-Port interface Size 14			Manifold rail with I-Port interface Size 18		
		L1 +5	L2 +5	L3	L1	L2	L3	L1	L2	L3
		VABM	4	152.5	143.5	31.5	177.5	167.5	48	181
	5	163	154	42	193.5	183.5	64	200	190	76
	6	173.5	164.5	52.5	209.5	199.5	80	219	209	95
	7	184	175	63	225.5	215.5	96	238	228	114
	8	194.5	185.5	73.5	241.5	231.5	112	257	247	133
	9	205	196	84	257.5	247.5	128	276	266	152
	10	215.5	206.5	94.5	273.5	263.5	144	295	285	171
	12	236.5	227.5	115.5	305.5	295.5	176	333	323	209
	16	278.5	269.5	157.5	369.5	359.5	240	409	399	285
	20	320.5	311.5	199.5	433.5	423.5	304	485	475	361
	24	362.5	353.5	241.5	497.5	487.5	368	561	551	437

Valve terminals VTUG with multi-pin plug and fieldbus connection

Technical data – Manifold rail VABM

Dimensions – Manifold rail outlet direction to the front

Download CAD data → www.festo.com

Control cabinet installation

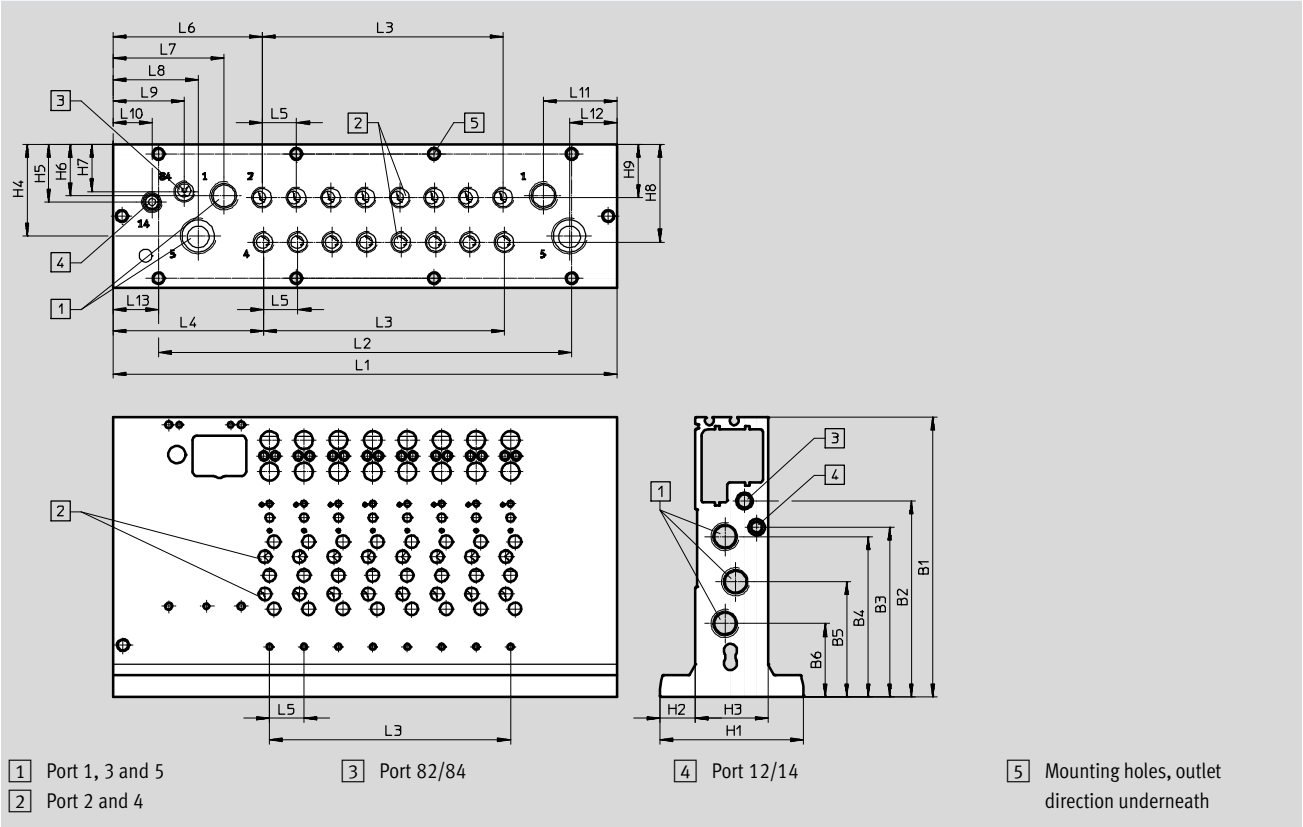

Type	Size 10																
	B1	B2	B3	B4	B5	B6	L4	L5	L6	L7	L8	L9	L10	L11	L12	L13	
VABM-L1-10HWS1	111.5	73.9	72.4	58.8	44.6	29.9	69.8	10.5	63	33.8	20	42	49.4	33.8	20	16.1	
VABM-L1-10HWS2																8	

Type	Size 10								
	H1	H2	H3	H4	H5	H6	H7	H8	H9
VABM-L1-10HWS1	54	15.5	23	31.9	19.8	19.8	34.3	34.5	19.1
VABM-L1-10HWS2									

Type	Size 14																
	B1	B2	B3	B4	B5	B6	L4	L5	L6	L7	L8	L9	L10	L11	L12	L13	
VABM-L1-14HWS1	130	91	78.8	74.5	53.5	34.1	69.8	16	96.2	51.5	39.5	33	18	34	22	35.5	
VABM-L1-14HWS2																21	

Type	Size 14								
	H1	H2	H3	H4	H5	H6	H7	H8	H9
VABM-L1-14HWS1	66.8	16.5	33.8	42.6	26.9	24	22	45.5	24.8
VABM-L1-14HWS2									

Valve terminals VTUG with multi-pin plug and fieldbus connection

FESTO

Technical data – Manifold rail VABM

No. of valve positions	L1	L2	L3	L13
VABM-L1-10HWS1-G18-4-GR	116.2	84	31.5	16.1
VABM-L1-10HWS1-G18-8-GR	158.2	126	73.5	16.1
VABM-L1-10HWS2-G18-8-GR	184	168	73.5	8
VABM-L1-10HWS2-G18-12-GR	226	210	115.5	8
VABM-L1-10HWS2-G18-16-GR	268	252	157.5	8
VABM-L1-10HWS2-G18-24-GR	352	336	241.5	8
VABM-L1-14HWS1-G14-4-GR	135	64	48	35.5
VABM-L1-14HWS1-G14-8-GR	199	128	112	35.5
VABM-L1-14HWS2-G14-8-GR	234	192	112	21
VABM-L1-14HWS2-G14-12-GR	298	256	176	21
VABM-L1-14HWS2-G14-16-GR	362	320	240	21
VABM-L1-14HWS2-G14-24-GR	490	448	368	21

Valve terminals VTUG with multi-pin plug and fieldbus connection

Technical data – Manifold rail VABM

Dimensions – Recess for control cabinet installation, outlet direction underneath/to the front, size 10

Up to 8 valves

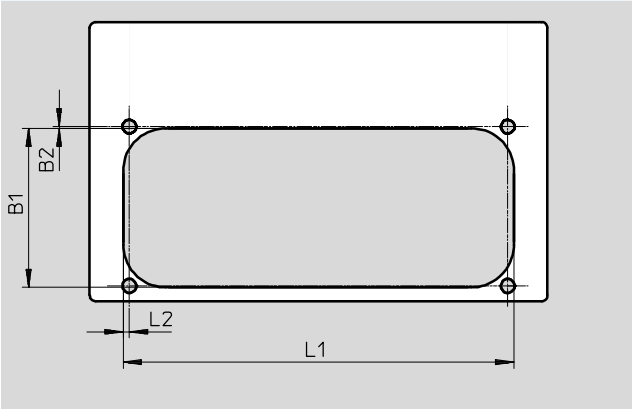

Type	B1	B2	L1	L2
VABM-L1-10...G18-4	52.7	0.5	86	2
VABM-L1-10...G18-5			96.5	
VABM-L1-10...G18-6			107	
VABM-L1-10...G18-7			117.5	
VABM-L1-10...G18-8			128	

9 or more valves

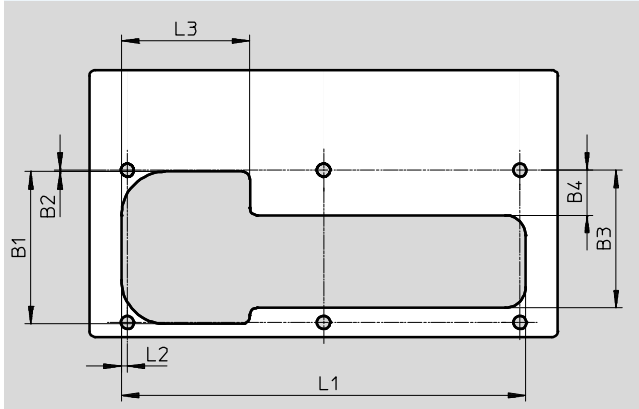

Type	B1	B2	B3	B4	L1	L2	L3
VABM-L1-10...G18-9	52.7	0.5	47.2	15.4	138.5	2	44
VABM-L1-10...G18-10					149		
VABM-L1-10...G18-12					170		
VABM-L1-10...G18-16					212		
VABM-L1-10...G18-20					254		
VABM-L1-10...G18-24					296		

Dimensions – Recess for control cabinet installation, outlet direction underneath/to the front, size 14

Up to 7 valves

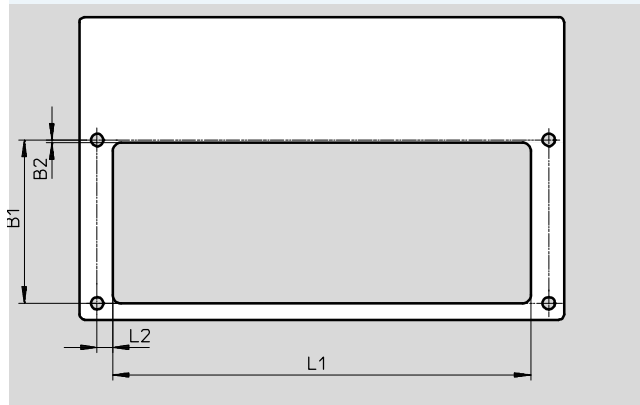

Type	B1	B2	L1	L2
VABM-L1-14...G14-4	59.3	1	103.9	5.6
VABM-L1-14...G14-5			119.9	
VABM-L1-14...G14-6			135.9	
VABM-L1-14...G14-7			151.9	

8 or more valves

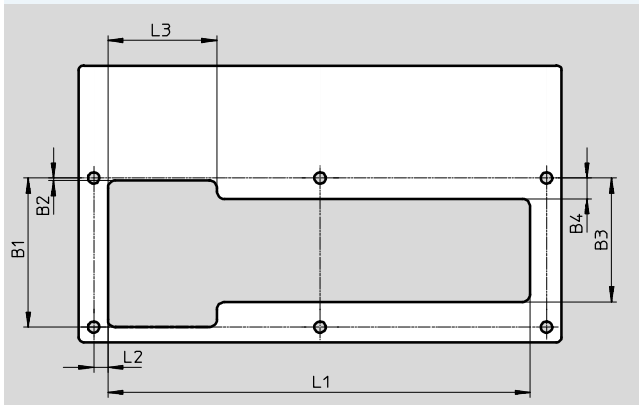

Type	B1	B2	B3	B4	L1	L2	L3
VABM-L1-14...G14-8	59.3	1	49.3	8.3	167.9	5.6	43.4
VABM-L1-14...G14-9					183.9		
VABM-L1-14...G14-10					199.9		
VABM-L1-14...G14-12					231.9		
VABM-L1-14...G14-16					295.9		
VABM-L1-14...G14-20					359.9		
VABM-L1-14...G14-24					423.9		

Valve terminals VTUG with multi-pin plug and fieldbus connection

Technical data – Manifold rail VABM

Dimensions – Recess for control cabinet installation, outlet direction underneath, size 18

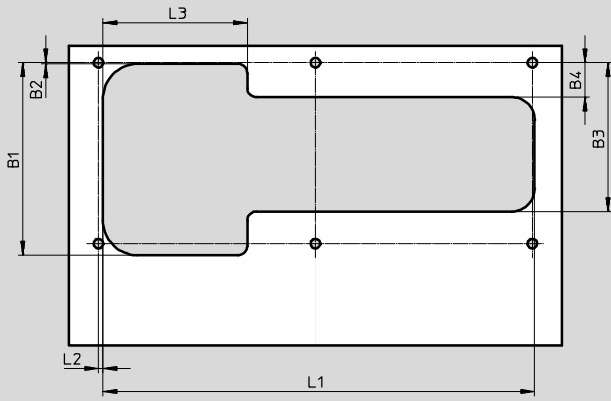

Type	B1	B2	B3	B4	L1	L2	L3
VABM-L1-18...G38-4	83.5	0.5	65	15	112.5	2	63
VABM-L1-18...G38-5					131.5		
VABM-L1-18...G38-6					150.5		
VABM-L1-18...G38-7					169.5		
VABM-L1-18...G38-8					188.5		
VABM-L1-18...G38-9					207.5		
VABM-L1-18...G38-10					226.5		
VABM-L1-18...G38-12					264.5		
VABM-L1-18...G38-16					340.5		
VABM-L1-18...G38-20					416.5		
VABM-L1-18...G38-24					492.5		

Valve terminals VTUG with multi-pin plug and fieldbus connection

Technical data – Manifold rail VABM

Dimensions – Mounting holes for control cabinet installation, size 10

Download CAD data → www.festo.com

Outlet direction underneath

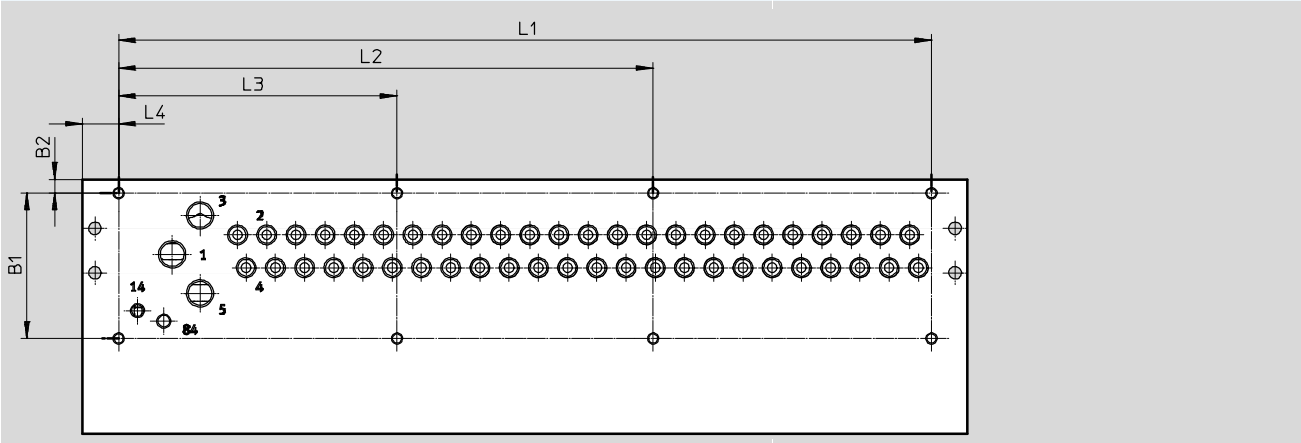

Type		Outlet direction of electrical components on top						I-Port interface on the side
		B1	B2	L1	L2	L3	L4	L4
VABM-L1-10...-G18-4	Up to 8 valves	52.2	5	82	–	–	13	62.5
VABM-L1-10...-G18-5				92.5	–	–		
VABM-L1-10...-G18-6				103	–	–		
VABM-L1-10...-G18-7				113.5	–	–		
VABM-L1-10...-G18-8				124	–	–		
VABM-L1-10...-G18-9	Up to 20 valves	52.2	5	134.5	–	67.25	13	62.5
VABM-L1-10...-G18-10				145	–	72.5		
VABM-L1-10...-G18-12				166	–	83		
VABM-L1-10...-G18-16				208	–	104		
VABM-L1-10...-G18-20				250	–	125		
VABM-L1-10...-G18-24	24 valves	52.2	5	292	192	100	13	62.5

Valve terminals VTUG with multi-pin plug and fieldbus connection

Technical data – Manifold rail VABM

Dimensions – Mounting holes for control cabinet installation, size 10

Download CAD data → www.festo.com

Outlet direction to the front

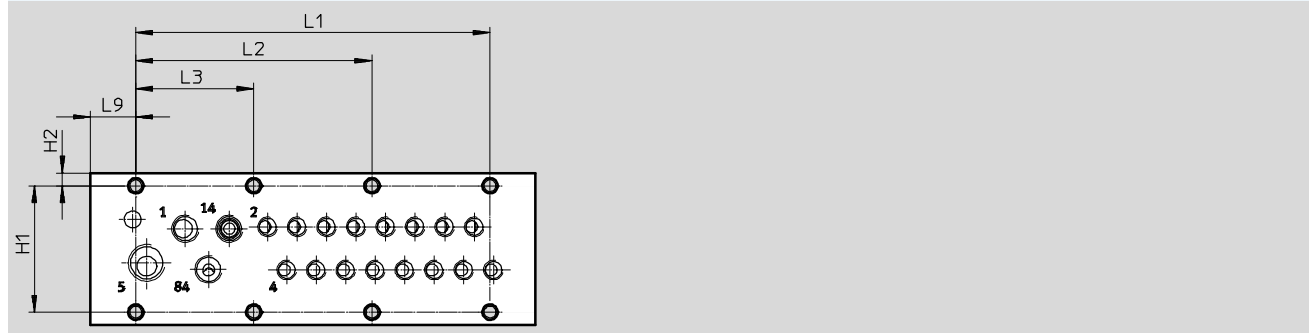

Type	H1	H2	L1	L2	L3	L9
VABM-L1-10HWS1-G18-4-GR	45	4.5	84	–	42	16.1
VABM-L1-10HWS1-G18-8-GR	45	4.5	126	84	42	16.1

Type	No. of valve positions	No. of mounting holes
VABM-L1-10HWS1-G18-4-GR	4	3
VABM-L1-10HWS1-G18-8-GR	8	4

Dimensions – Mounting holes for control cabinet installation, size 10

Download CAD data → www.festo.com

Outlet direction to the front

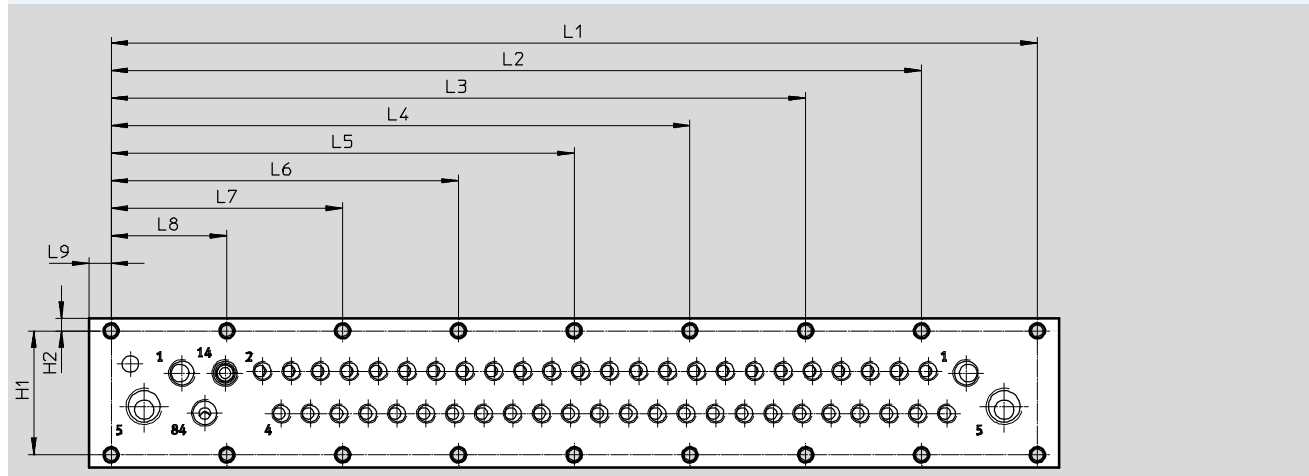

Type	H1	H2	L1	L2	L3	L4	L5	L6	L7	L8	L9
VABM-L1-10HWS2-G18-8-GR	45	4.5	168	–	–	–	–	126	84	42	8
VABM-L1-10HWS2-G18-12-GR	45	4.5	210	–	–	–	168	126	84	42	8
VABM-L1-10HWS2-G18-16-GR	45	4.5	252	–	–	210	168	126	84	42	8
VABM-L1-10HWS2-G18-24-GR	45	4.5	336	294	252	210	168	126	84	42	8

Type	No. of valve positions	No. of mounting holes
VABM-L1-10HWS2-G18-8-GR	8	5
VABM-L1-10HWS2-G18-12-GR	12	6
VABM-L1-10HWS2-G18-16-GR	16	7
VABM-L1-10HWS2-G18-24-GR	24	9

Valve terminals VTUG with multi-pin plug and fieldbus connection

Technical data – Manifold rail VABM

Dimensions – Mounting holes for control cabinet installation, size 14

Download CAD data → www.festo.com

Outlet direction underneath

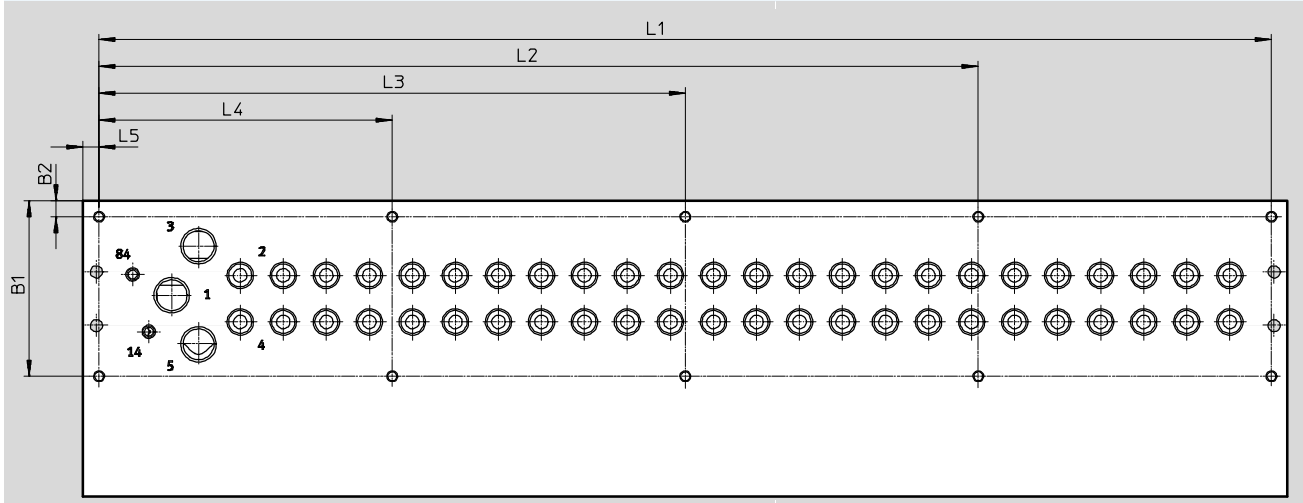

Type		Outlet direction of electrical components on top							I-Port interface on the side
		B1	B2	L1	L2	L3	L4	L5	L4
VABM-L1-14...-G14-4	Up to 8 valves	59.3	6	116	-	-	-	6	55.5
VABM-L1-14...-G14-5				132	-	-	-		
VABM-L1-14...-G14-6				148	-	-	-		
VABM-L1-14...-G14-7				164	-	-	-		
VABM-L1-14...-G14-8	8 to 10 valves	59.3	6	180	-	-	90	6	55.5
VABM-L1-14...-G14-9				196	-	-	98		
VABM-L1-14...-G14-10				212	-	-	106		
VABM-L1-14...-G14-12	12 valves and	59.3	6	244	-	162	82	6	55.5
VABM-L1-14...-G14-16	16 valves			308	-	204	104		
VABM-L1-14...-G14-20	20 valves and	59.3	6	372	279	186	93	6	55.5
VABM-L1-14...-G14-24	24 valves			436	327	218	109		

Valve terminals VTUG with multi-pin plug and fieldbus connection

Technical data – Manifold rail VABM

Dimensions – Mounting holes for control cabinet installation, size 14 Download CAD data → www.festo.com
 Outlet direction to the front

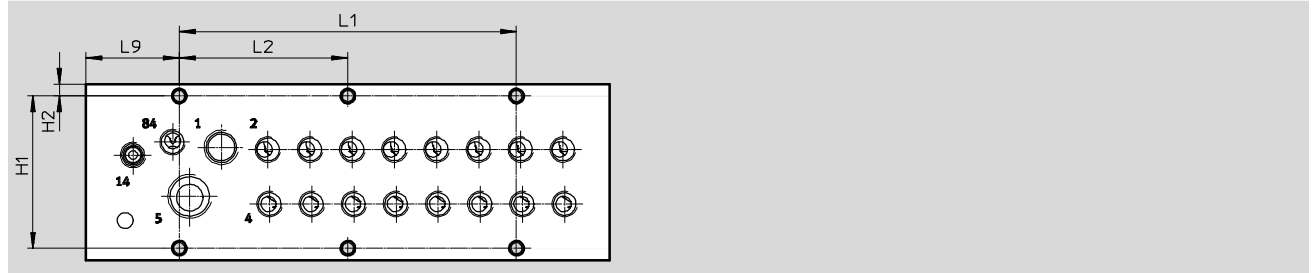

Type	H1	H2	L1	L2	L9
VABM-L1-14HWS1-G14-4-GR	57.8	4.5	64	–	35.5
VABM-L1-14HWS1-G14-8-GR	57.8	4.5	128	64	35.5

Type	No. of valve positions	No. of mounting holes
VABM-L1-14HWS1-G14-4-GR	4	2
VABM-L1-14HWS1-G14-8-GR	8	3

Dimensions – Mounting holes for control cabinet installation, size 14 Download CAD data → www.festo.com
 Outlet direction to the front

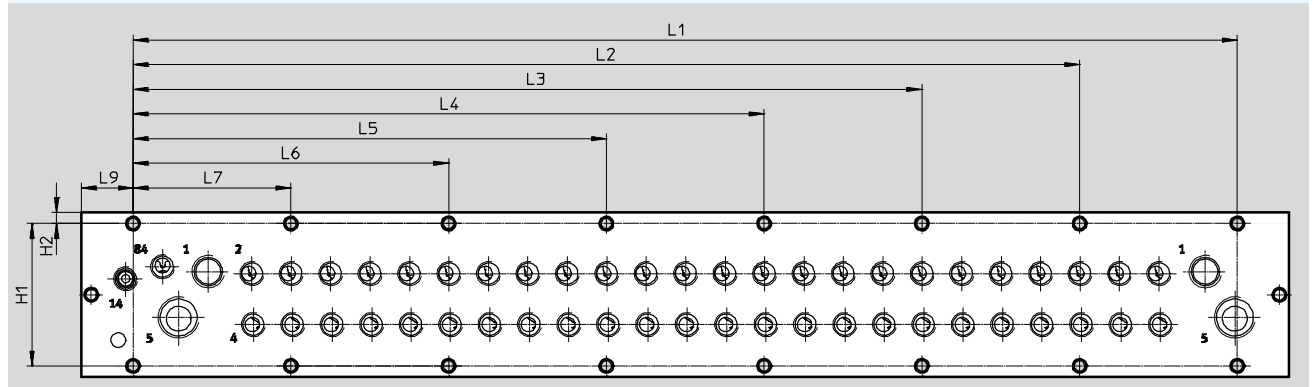

Type	H1	H2	L1	L2	L3	L4	L5	L6	L7	L9
VABM-L1-14HWS2-G14-8-GR	57.8	4.5	192	–	–	–	–	128	64	21
VABM-L1-14HWS2-G14-12-GR	57.8	4.5	256	–	–	–	192	128	64	21
VABM-L1-14HWS2-G14-16-GR	57.8	4.5	320	–	–	256	192	128	64	21
VABM-L1-14HWS2-G14-24-GR	57.8	4.5	448	384	320	256	192	128	64	21

Type	No. of valve positions	No. of mounting holes
VABM-L1-14HWS2-G14-8-GR	8	4
VABM-L1-14HWS2-G14-12-GR	12	5
VABM-L1-14HWS2-G14-16-GR	16	6
VABM-L1-14HWS2-G14-24-GR	24	8

Valve terminals VTUG with multi-pin plug and fieldbus connection

Technical data – Manifold rail VABM

Dimensions – Mounting holes for control cabinet installation, size 18

Download CAD data → www.festo.com

Outlet direction underneath

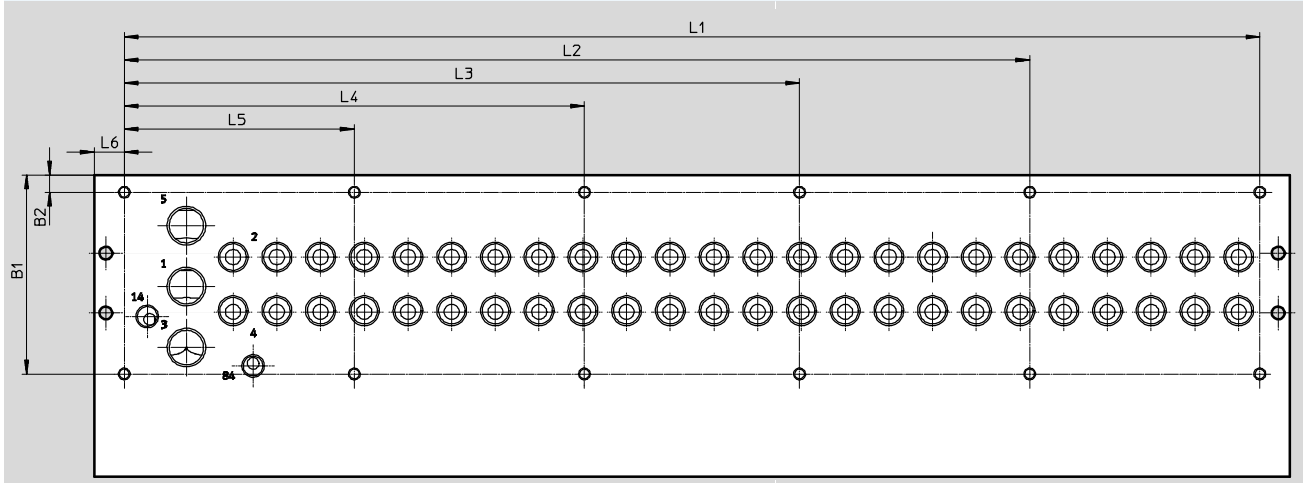

Type		Outlet direction of electrical components							I-Port interface on the side
		B1	B2	L1	L2	L3	L4	L5	L4
VABM-L1-18...-G38-4	4 valves and	86.5	7.5	113.5	-	-	-	-	54.5
VABM-L1-18...-G38-5	5 valves			132.5	-	-	-	-	
VABM-L1-18...-G38-6	6 to 10 valves	86.5	7.5	151.5	-	-	-	75.8	54.5
VABM-L1-18...-G38-7				170.5	-	-	-	85.3	
VABM-L1-18...-G38-8				189.5	-	-	-	94.8	
VABM-L1-18...-G38-9				208.5	-	-	-	104.3	
VABM-L1-18...-G38-10				227.5	-	-	-	113.8	
VABM-L1-18...-G38-12	12 valves	86.5	7.5	265.5	-	-	165.5	100	54.5
VABM-L1-18...-G38-16	16 to 20 positions	86.5	7.5	341.5	-	-	170.8	100	54.5
VABM-L1-18...-G38-20				417.5	-	317.5	208.8	100	
VABM-L1-18...-G38-24	24 valves	86.5	7.5	493.5	393.5	293.5	200	100	54.5

Valve terminals VTUG with multi-pin plug and fieldbus connection

FESTO

Ordering data

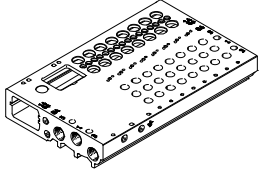
Ordering data				
	Description	Part No.	Type	
Manifold rail for semi in-line valve				
	Valve size 10 mm			
	Port 2, 4 on the valve	4 valve positions	573423	VABM-L1-10G-G18-4-GR
		5 valve positions	573424	VABM-L1-10G-G18-5-GR
		6 valve positions	573425	VABM-L1-10G-G18-6-GR
		7 valve positions	573426	VABM-L1-10G-G18-7-GR
		8 valve positions	573427	VABM-L1-10G-G18-8-GR
		9 valve positions	573428	VABM-L1-10G-G18-9-GR
		10 valve positions	573429	VABM-L1-10G-G18-10-GR
		12 valve positions	573430	VABM-L1-10G-G18-12-GR
		16 valve positions	573431	VABM-L1-10G-G18-16-GR
		20 valve positions	573432	VABM-L1-10G-G18-20-GR
		24 valve positions	573433	VABM-L1-10G-G18-24-GR
		8 double solenoid + 8 single solenoid valves	573927	VABM-L1-10G-G18-16-M-GR
		4 double solenoid + 16 single solenoid valves	573928	VABM-L1-10G-G18-20-M-GR
		24 single solenoid valves	573929	VABM-L1-10G-G18-24-M-GR
	Valve size 14 mm			
	Port 2, 4 on the valve	4 valve positions	573489	VABM-L1-14G-G14-4-GR
		5 valve positions	573490	VABM-L1-14G-G14-5-GR
		6 valve positions	573491	VABM-L1-14G-G14-6-GR
		7 valve positions	573492	VABM-L1-14G-G14-7-GR
		8 valve positions	573493	VABM-L1-14G-G14-8-GR
		9 valve positions	573494	VABM-L1-14G-G14-9-GR
		10 valve positions	573495	VABM-L1-14G-G14-10-GR
		12 valve positions	573496	VABM-L1-14G-G14-12-GR
		16 valve positions	573497	VABM-L1-14G-G14-16-GR
		20 valve positions	573498	VABM-L1-14G-G14-20-GR
		24 valve positions	573499	VABM-L1-14G-G14-24-GR
		8 double solenoid + 8 single solenoid valves	573933	VABM-L1-14G-G14-16-M-GR
		4 double solenoid + 16 single solenoid valves	573934	VABM-L1-14G-G14-20-M-GR
		24 single solenoid valves	573935	VABM-L1-14G-G14-24-M-GR
	Valve size 18 mm			
	Port 2, 4 on the valve	4 valve positions	8004899	VABM-L1-18G-G38-4-G
		5 valve positions	8004900	VABM-L1-18G-G38-5-G
		6 valve positions	8004901	VABM-L1-18G-G38-6-G
		7 valve positions	8004902	VABM-L1-18G-G38-7-G
		8 valve positions	8004903	VABM-L1-18G-G38-8-G
		9 valve positions	8004904	VABM-L1-18G-G38-9-G
		10 valve positions	8004905	VABM-L1-18G-G38-10-G
		12 valve positions	8004906	VABM-L1-18G-G38-12-G
		16 valve positions	8004907	VABM-L1-18G-G38-16-G
		20 valve positions	8004908	VABM-L1-18G-G38-20-G
		24 valve positions	8004909	VABM-L1-18G-G38-24-G
8 double solenoid + 8 single solenoid valves		8004910	VABM-L1-18G-G38-16-M-G	
4 double solenoid + 16 single solenoid valves		8004911	VABM-L1-18G-G38-20-M-G	
24 single solenoid valves		8004912	VABM-L1-18G-G38-24-M-G	

Valve terminals VTUG with multi-pin plug and fieldbus connection

Ordering data

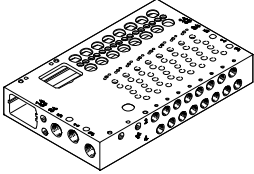
Ordering data		Description	Part No.	Type
Manifold rail for sub-base valve				
	Valve size 10 mm			
	Port 2, 4 at front	4 valve positions	573434	VABM-L1-10HW-G18-4-GR
		5 valve positions	573435	VABM-L1-10HW-G18-5-GR
		6 valve positions	573436	VABM-L1-10HW-G18-6-GR
		7 valve positions	573437	VABM-L1-10HW-G18-7-GR
		8 valve positions	573438	VABM-L1-10HW-G18-8-GR
		9 valve positions	573439	VABM-L1-10HW-G18-9-GR
		10 valve positions	573440	VABM-L1-10HW-G18-10-GR
		12 valve positions	573441	VABM-L1-10HW-G18-12-GR
		16 valve positions	573442	VABM-L1-10HW-G18-16-GR
		20 valve positions	573443	VABM-L1-10HW-G18-20-GR
		24 valve positions	573444	VABM-L1-10HW-G18-24-GR
		8 double solenoid + 8 single solenoid valves	573930	VABM-L1-10HW-G18-16-M-GR
		4 double solenoid + 16 single solenoid valves	573931	VABM-L1-10HW-G18-20-M-GR
	24 single solenoid valves	573932	VABM-L1-10HW-G18-24-M-GR	
	Valve size 14 mm			
	Port 2, 4 at front	4 valve positions	573500	VABM-L1-14W-G14-4-GR
		5 valve positions	573501	VABM-L1-14W-G14-5-GR
		6 valve positions	573502	VABM-L1-14W-G14-6-GR
		7 valve positions	573503	VABM-L1-14W-G14-7-GR
		8 valve positions	573504	VABM-L1-14W-G14-8-GR
		9 valve positions	573505	VABM-L1-14W-G14-9-GR
		10 valve positions	573506	VABM-L1-14W-G14-10-GR
		12 valve positions	573507	VABM-L1-14W-G14-12-GR
		16 valve positions	573508	VABM-L1-14W-G14-16-GR
		20 valve positions	573509	VABM-L1-14W-G14-20-GR
		24 valve positions	573510	VABM-L1-14W-G14-24-GR
		8 double solenoid + 8 single solenoid valves	573936	VABM-L1-14W-G14-16-M-GR
		4 double solenoid + 16 single solenoid valves	573937	VABM-L1-14W-G14-20-M-GR
	24 single solenoid valves	573938	VABM-L1-14W-G14-24-M-GR	
	Valve size 18 mm			
	Port 2, 4 at front	4 valve positions	8004913	VABM-L1-18W-G38-4-G
		5 valve positions	8004914	VABM-L1-18W-G38-5-G
		6 valve positions	8004915	VABM-L1-18W-G38-6-G
		7 valve positions	8004916	VABM-L1-18W-G38-7-G
		8 valve positions	8004917	VABM-L1-18W-G38-8-G
		9 valve positions	8004918	VABM-L1-18W-G38-9-G
		10 valve positions	8004919	VABM-L1-18W-G38-10-G
		12 valve positions	8004920	VABM-L1-18W-G38-12-G
		16 valve positions	8004921	VABM-L1-18W-G38-16-G
		20 valve positions	8004922	VABM-L1-18W-G38-20-G
		24 valve positions	8004923	VABM-L1-18W-G38-24-G
8 double solenoid + 8 single solenoid valves		8004924	VABM-L1-18W-G38-16-M-G	
4 double solenoid + 16 single solenoid valves		8004925	VABM-L1-18W-G38-20-M-G	
24 single solenoid valves	8004926	VABM-L1-18W-G38-24-M-G		

Valve terminals VTUG with multi-pin plug and fieldbus connection

Ordering data

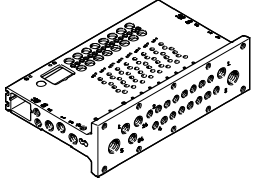
Ordering data				
	Description	Part No.	Type	
Manifold rail for sub-base valve, for control cabinet installation, outlet direction to the front				
	Valve size 10 mm			
	Port 2, 4 at the front, single infeed	4 valve positions	8058335	VABM-L1-10HWS1-G18-4-GR
		8 valve positions	8058336	VABM-L1-10HWS1-G18-8-GR
	Port 2, 4 at the front, double infeed	8 valve positions	8058338	VABM-L1-10HWS2-G18-8-GR
		12 valve positions	8058339	VABM-L1-10HWS2-G18-12-GR
		16 valve positions	8058340	VABM-L1-10HWS2-G18-16-GR
		24 valve positions	8058341	VABM-L1-10HWS2-G18-24-GR
	Valve size 14 mm			
	Port 2, 4 at the front, single infeed	4 valve positions	8058342	VABM-L1-14HWS1-G14-4-GR
		8 valve positions	8058343	VABM-L1-14HWS1-G14-8-GR
	Port 2, 4 at the front, double infeed	8 valve positions	8058344	VABM-L1-14HWS2-G14-8-GR
		12 valve positions	8058345	VABM-L1-14HWS2-G14-12-GR
		16 valve positions	8058346	VABM-L1-14HWS2-G14-16-GR
		24 valve positions	8058347	VABM-L1-14HWS2-G14-24-GR

Valve terminals VTUG with multi-pin plug connection

Technical data – Multi-pin plug connection

The following multi-pin plug connections are available for the valve terminal VTUG:

- Sub-D (25-pin)
- Sub-D (44-pin)
- Flat cable (26-pin)
- Flat cable (50-pin)



Electrical multi-pin plug

Each pin on the multi-pin plug can actuate exactly one solenoid coil.

If the maximum configurable number of valve positions is 24, this means that 48 valve functions can be addressed.

The valves can be switched by means of positive or negative logic (positive switching or negative switching).

Mixed operation is generally not possible; however, an exception is made for the V22 ... V25 variants with 25-pin Sub-D. With these variants, a specific range of valve positions (e.g. Com 16...19) is supplied with common voltage.

This allows these ranges to be switched with positive or negative logic and valve groups to be switched off independently of the other ranges. Mixed operation within a range is not permitted.



Note

A double solenoid valve occupies one valve position and two pins on the multi-pin plug. This means that the number of double solenoid valves per manifold rail is limited. (Pin allocation → page 184)

General technical data				
Type	VAEM-L1-S-M1-25	VAEM-L1-S-M1-44	VAEM-L1-S-M3-26	VAEM-L1-S-M3-50
Number of pins	25-pin	44-pin	26-pin	50-pin
Electrical connection	Sub-D plug		Flat cable plug	
Max. no. of valve positions	24		24	
Degree of protection to EN 60529	IP67		IP40	
Material	PA		PA	
Note on materials	RoHS compliant		RoHS compliant	
Certification	c UL us - Recognized (OL)			
	c CSA us (OL)			
CE mark (see declaration of conformity) ¹⁾	In accordance with EU EMC Directive			
Corrosion resistance class CRC ²⁾	2			
Weight [g]	53		45	48

1) For information about the applicability of the component see the manufacturer's EC declaration of conformity at: www.festo.com/sp → Certificates.

If the component is subject to restrictions on usage in residential, office or commercial environments or small businesses, further measures to reduce the emitted interference may be necessary.

2) Corrosion resistance class CRC 2 to Festo standard FN 940070

Moderate corrosion stress. Indoor applications in which condensation may occur. External visible parts with primarily decorative requirements for the surface and which are in direct contact with the ambient atmosphere typical for industrial applications.

Valve terminals VTUG with multi-pin plug connection

Technical data – Multi-pin plug connection

Pin allocation – Sub-D plug, 25-pin												
	Pin	Wire colour ¹⁾	M1-25 (V20)								M1-25V1 (V22)	
			12x double solenoid		8x double solenoid 8x single solenoid		4x double solenoid 16x single solenoid		24x single solenoid			
	1	WH	VP0	14	VP0	14	VP0	14	VP0	14	VP0	14
	2	BN	VP0	12	VP0	12	VP0	12	VP23	14	VP0	12
	3	GN	VP1	14	VP1	14	VP1	14	VP1	14	VP1	14
	4	YE	VP1	12	VP1	12	VP1	12	VP22	14	VP1	12
	5	GY	VP2	14	VP2	14	VP2	14	VP2	14	VP2	14
	6	PK	VP2	12	VP2	12	VP2	12	VP21	14	VP2	12
	7	BU	VP3	14	VP3	14	VP3	14	VP3	14	VP3	14
	8	RD	VP3	12	VP3	12	VP3	12	VP20	14	VP3	12
	9	BK	VP4	14	VP4	14	VP4	14	VP4	14	VP4	14
	10	VT	VP4	12	VP4	12	VP19	14	VP19	14	VP4	12
	11	GY PK	VP5	14	VP5	14	VP5	14	VP5	14	VP5	14
	12	RD BU	VP5	12	VP5	12	VP18	14	VP18	14	VP5	12
	13	GN WH	VP6	14	VP6	14	VP6	14	VP6	14	VP6	14
	14	BN GN	VP6	12	VP6	12	VP17	14	VP17	14	VP6	12
	15	YE WH	VP7	14	VP7	14	VP7	14	VP7	14	VP7	14
	16	BN YE	VP7	12	VP7	12	VP16	14	VP16	14	VP7	12
	17	GY WH	VP8	14	VP8	14	VP8	14	VP8	14	VP8	14
	18	BN GY	VP8	12	VP15	14	VP15	14	VP15	14	VP8	12
	19	WH PK	VP9	14	VP9	14	VP9	14	VP9	14	VP9	14
	20	BN PK	VP9	12	VP14	14	VP14	14	VP14	14	VP9	12
	21	BU WH	VP10	14	VP10	14	VP10	14	VP10	14	Com 16 ... 19	
	22	BN BU	VP10	12	VP13	14	VP13	14	VP13	14	Com 12 ... 15	
	23	RD WH	VP11	14	VP11	14	VP11	14	VP11	14	Com 8 ... 11	
	24	BN RD	VP11	12	VP12	14	VP12	14	VP12	14	Com 4 ... 7	
	25	BK WH	Com		Com		Com	Com	Com		Com 0 ... 3	

1) To IEC 60757
VP Valve position

Note
A grey field means that a double solenoid valve can be used, while a white field means that only single solenoid valves can be used.

Valve terminals VTUG with multi-pin plug connection

Technical data – Multi-pin plug connection

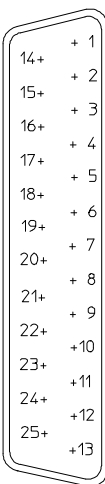
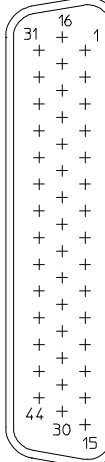
Pin allocation – Sub-D plug, 25-pin								Pin allocation – Sub-D plug, 44-pin					
	Pin	Wire colour ¹⁾	M1-25V2 (V23)		M1-25V3 (V24)		M1-25V4 (V25)		Pin	Wire colour ¹⁾	M1-44 (V21)		
													18x double solenoid, 6x single solenoid
	1	WH	VP0	14	VP0	14	VP0	14		1	WH	VP0	14
	2	BN	VP0	12	VP0	12	VP1	14		2	BN	VP0	12
	3	GN	VP1	14	VP1	14	VP2	14		3	GN	VP1	14
	4	YE	VP1	12	VP1	12	VP3	14		4	YE	VP1	12
	5	GY	VP2	14	VP2	14	VP4	14		5	GY	VP2	14
	6	PK	VP2	12	VP2	12	VP5	14		6	PK	VP2	12
	7	BU	VP3	14	VP3	14	VP6	14		7	BU	VP3	14
	8	RD	VP3	12	VP3	12	VP7	14		8	RD	VP3	12
	9	BK	VP4	14	VP4	14	VP8	14		9	BK	VP4	14
	10	VT	VP4	12	VP5	14	VP9	14		10	VT	VP4	12
	11	GY PK	VP5	14	VP6	14	VP10	14		11	GY PK	VP5	14
	12	RD BU	VP5	12	VP7	14	VP11	14		12	RD BU	VP5	12
	13	GN WH	VP6	14	VP8	14	VP12	14		13	GN WH	VP6	14
	14	BN GN	VP6	12	VP9	14	VP13	14		14	BN GN	VP6	12
	15	YE WH	VP7	14	VP10	14	VP14	14		15	YE WH	VP7	14
	16	BN YE	VP7	12	VP11	14	VP15	14		16	BN YE	VP7	12
	17	GY WH	VP8	14	VP12	14	VP16	14		17	GY WH	VP8	14
	18	BN GY	VP9	14	VP13	14	VP17	14		18	BN GY	VP8	12
	19	WH PK	VP10	14	VP14	14	VP18	14		19	WH PK	VP9	14
	20	BN PK	VP11	14	VP15	14	VP19	14		20	BN PK	VP9	12
	21	BU WH	Com 16 ... 19		Com 16 ... 19		Com 16 ... 19			21	BU WH	VP10	14
	22	BN BU	Com 12 ... 15		Com 12 ... 15		Com 12 ... 15			22	BN BU	VP10	12
	23	RD WH	Com 8 ... 11		Com 8 ... 11		Com 8 ... 11			23	RD WH	VP11	14
	24	BN RD	Com 4 ... 7		Com 4 ... 7		Com 4 ... 7			24	BN RD	VP11	12
	25	BK WH	Com 0 ... 3		Com 0 ... 3		Com 0 ... 3			25	BK WH	VP12	14
-								26	BK BN	VP12	12		
-								27	GN GY	VP13	14		
-								28	YE GY	VP13	12		
-								29	GN PK	VP14	14		
-								30	YE PK	VP14	12		
-								31	GN BU	VP15	14		
-								32	YE BU	VP15	12		
-								33	RD GN	VP16	14		
-								34	RD YE	VP16	12		
-								35	BK GN	VP17	14		
-								36	BK YE	VP17	12		
-								37	BU GY	VP18	14		
-								38	BU PK	VP19	14		
-								39	RD GY	VP20	14		
-								40	RD PK	VP21	14		
-								41	BK GY	VP22	14		
-								42	BK PK	VP23	14		
-								43	BK BU	com			
-								44	BK RD				

1) To IEC 60757
VP Valve position

 - Note
A grey field means that a double solenoid valve can be used, while a white field means that only single solenoid valves can be used.

Valve terminals VTUG with multi-pin plug connection

Technical data – Multi-pin plug connection

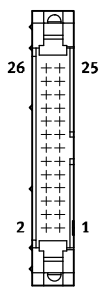
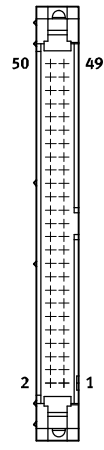
Pin allocation – Flat cable, 26-pin										Pin allocation – Flat cable, 50-pin			
Pin	M3-26 (V20)								Pin	M3-50 (V26)			
	12x double solenoid		8x double solenoid 8x single solenoid		4x double solenoid 16x single solenoid		24x single solenoid						
	1	VP0	14	VP0	14	VP0	14	VP0	14		1	VP0	14
	2	VP0	12	VP0	12	VP0	12	VP23	14		2	VP0	12
	3	VP1	14	VP1	14	VP1	14	VP1	14		3	VP1	14
	4	VP1	12	VP1	12	VP1	12	VP22	14		4	VP1	12
	5	VP2	14	VP2	14	VP2	14	VP2	14		5	VP2	14
	6	VP2	12	VP2	12	VP2	12	VP21	14		6	VP2	12
	7	VP3	14	VP3	14	VP3	14	VP3	14		7	VP3	14
	8	VP3	12	VP3	12	VP3	12	VP20	14		8	VP3	12
	9	VP4	14	VP4	14	VP4	14	VP4	14		9	VP4	14
	10	VP4	12	VP4	12	VP19	14	VP19	14		10	VP4	12
	11	VP5	14	VP5	14	VP5	14	VP5	14		11	VP5	14
	12	VP5	12	VP5	12	VP18	14	VP18	14		12	VP5	12
	13	VP6	14	VP6	14	VP6	14	VP6	14		13	VP6	14
	14	VP6	12	VP6	12	VP17	14	VP17	14		14	VP6	12
	15	VP7	14	VP7	14	VP7	14	VP7	14		15	VP7	14
	16	VP7	12	VP7	12	VP16	14	VP16	14		16	VP7	12
	17	VP8	14	VP8	14	VP8	14	VP8	14		17	VP8	14
	18	VP8	12	VP15	14	VP15	14	VP15	14		18	VP8	12
	19	VP9	14	VP9	14	VP9	14	VP9	14		19	VP9	14
	20	VP9	12	VP14	14	VP14	14	VP14	14		20	VP9	12
	21	VP10	14	VP10	14	VP10	14	VP10	14		21	VP10	14
	22	VP10	12	VP13	14	VP13	14	VP13	14		22	VP10	12
	23	VP11	14	VP11	14	VP11	14	VP11	14		23	VP11	14
	24	VP11	12	VP12	14	VP12	14	VP12	14		24	VP11	12
	25	Com		Com		Com	Com	Com			25	VP12	14
	26	Com		Com		Com		Com			26	VP12	12
-									27	VP13	14		
-									28	VP13	12		
-									29	VP14	14		
-									30	VP14	12		
-									31	VP15	14		
-									32	VP15	12		
-									33	VP16	14		
-									34	VP16	12		
-									35	VP17	14		
-									36	VP17	12		
-									37	VP18	14		
-									38	VP18	12		
-									39	VP19	14		
-									40	VP19	12		
-									41	VP20	14		
-									42	VP20	12		
-									43	VP21	14		
-									44	VP21	12		
-									45	VP22	14		
-									46	VP22	12		
-									47	VP23	14		
-									48	VP23	12		
-									49	Com			
-									50				

 Note
 A grey field means that a double solenoid valve can be used, while a white field means that only single solenoid valves can be used.

VP Valve position

Valve terminals VTUG with multi-pin plug connection

Technical data – Multi-pin plug connection

Dimensions

Download CAD data → www.festo.com

Multi-pin plug connection, Sub-D

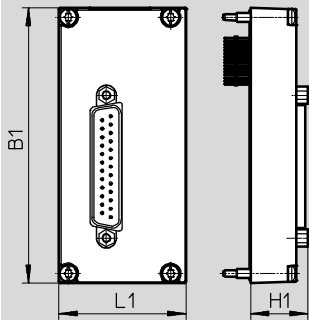

-  - Note

Dimensions of the manifold rail with electrical connection (→ page 162)

Type	B1	L1	H1
VAEM-L1-S-M1-...	90.5	41.9	18.9

Dimensions

Download CAD data → www.festo.com

Multi-pin plug connection, flat cable

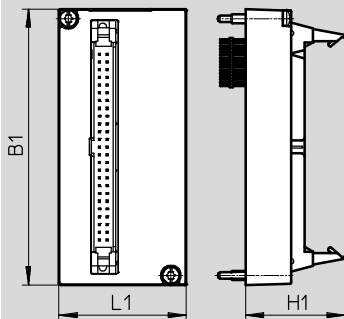



-  - Note

Dimensions of the manifold rail with electrical connection (→ page 162)

Type	B1	L1	H1
VAEM-L1-S-M3-...	90.5	41.9	32.7

Valve terminals VTUG with multi-pin plug connection

Accessories – Multi-pin plug connection

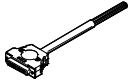
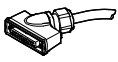
Ordering data – Multi-pin plug connection					
Description		Part No.	Type		
Electrical interface, Sub-D					
	25-pin	For variant M1-25 (V20)	573445	VAEM-L1-S-M1-25	
		For variant M1-25V1 (V22)	573447	VAEM-L1-S-M1-25V1	
		For variant M1-25V2 (V23)	573448	VAEM-L1-S-M1-25V2	
		For variant M1-25V3 (V24)	573449	VAEM-L1-S-M1-25V3	
		For variant M1-25V4 (V25)	573450	VAEM-L1-S-M1-25V4	
	44-pin	For variant M1-44 (V21)	573446	VAEM-L1-S-M1-44	
Electrical interface, flat cable plug					
	26-pin	For variant M3-26 (V20)	573452	VAEM-L1-S-M3-26	
	50-pin	For variant M3-50 (V26)	573451	VAEM-L1-S-M3-50	
Connecting cable for multi-pin plug					
	Sub-D socket, straight	<ul style="list-style-type: none"> • 25-pin, up to 24 coils, IP40 • Open cable end, 25-wire 	2.5 m	575417	NEBV-S1G25-K-2.5-N-LE25-S6
			5 m	575418	NEBV-S1G25-K-5-N-LE25-S6
			10 m	575419	NEBV-S1G25-K-10-N-LE25-S6
		<ul style="list-style-type: none"> • 44-pin, up to 42 coils, IP40 • Open cable end, 44-wire 	2.5 m	575113	NEBV-S1G44-K-2.5-N-LE44-S6
			5 m	575114	NEBV-S1G44-K-5-N-LE44-S6
			10 m	575115	NEBV-S1G44-K-10-N-LE44-S6
	Sub-D socket, angled	<ul style="list-style-type: none"> • 25-pin, up to 24 coils, IP65 • Open cable end, 25-wire 	2.5 m	575423	NEBV-S1WA25-K-2.5-N-LE25-S9
			5 m	575424	NEBV-S1WA25-K-5-N-LE25-S9
			10 m	575425	NEBV-S1WA25-K-10-N-LE25-S9
		<ul style="list-style-type: none"> • 44-pin, up to 42 coils, IP65 • Open cable end, 44-wire 	2.5 m	575420	NEBV-S1WA44-K-2.5-N-LE44-S9
			5 m	575421	NEBV-S1WA44-K-5-N-LE44-S9
			10 m	575422	NEBV-S1WA44-K-10-N-LE44-S9

Valve terminals VTUG, I-Port interface/IO-Link

Technical data – I-Port interface/IO-Link

Festo-specific, standardised interface for direct connection to the fieldbus by mounting the bus node CTEU or to an IO-Link master via a cable (in IO-Link mode).

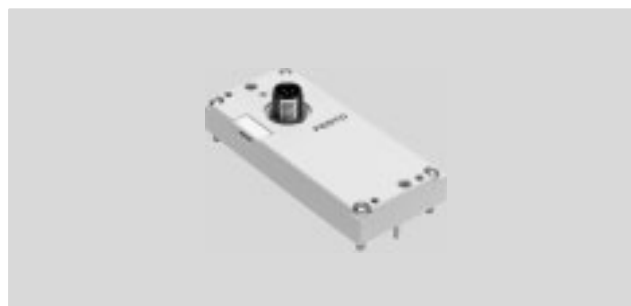

I-Port interface/IO-Link

Versions:

- I-Port interface for bus nodes (CTEU)
- IO-Link mode for direct connection to a higher-order IO-Link master

The following protocols are supported in connection with the associated CTEU bus node:

- CANopen
- DeviceNet
- PROFIBUS
- CC-LINK
- EtherCAT

The electrical supply/transmission of communication takes place via an M12 plug connector.

The valve terminal can be equipped with 4 ... 24 (double solenoid) valves.

General technical data

Communication types	IO-Link		
Electrical connection	<ul style="list-style-type: none"> • Plug connector M12, 5-pin • A-coded • Metal thread for screening 		
Baud rates	COM3	[kbps]	230.4
	COM2	[kbps]	38.4
Intrinsic current consumption, logic supply PS		[mA]	30
Intrinsic current consumption, valve supply PL		[mA]	30
Max. number of solenoid coils	VAEM-L1-S-8-PT		16
	VAEM-L1-S-16-PT		32
	VAEM-L1-S-24-PT		48
Max. no. of valve positions	VAEM-L1-S-8-PT		8
	VAEM-L1-S-16-PT		16
	VAEM-L1-S-24-PT		24
Ambient temperature		[°C]	-5 ... +50
Product weight	Outlet on top	[g]	49
	Outlet on the side	[g]	100
Degree of protection to EN 60529	IP67		
Certification	c UL us - Recognized (OL)		
	c CSA us (OL)		
CE mark (see declaration of conformity) ¹⁾	In accordance with EU EMC Directive		
Corrosion resistance class CRC ²⁾	2		

1) For information about the applicability of the component see the manufacturer's EC declaration of conformity at: www.festo.com/sp → Certificates.

If the component is subject to restrictions on usage in residential, office or commercial environments or small businesses, further measures to reduce the emitted interference may be necessary.

2) Corrosion resistance class CRC 2 to Festo standard FN 940070

Moderate corrosion stress. Indoor applications in which condensation may occur. External visible parts with primarily decorative requirements for the surface and which are in direct contact with the ambient atmosphere typical for industrial applications.

Valve terminals VTUG, I-Port interface/IO-Link

Technical data – I-Port interface/IO-Link

LED display			
	Colour	Status	Function
Status LED X1	Red/ green	Off	No 24 V logic
		Static green	Everything OK
		Flashing green	Communication error (in the I-Port or IO-Link protocol)
		Flashing red/green	Load supply error (undervoltage or no load supply)
		Static red	Load supply error and communication error

Pin allocation – I-Port interface/IO-Link			
	Pin	Allocation	Description
	1	24V _{EL/SEN}	Operating voltage supply (electronics, sensors/inputs)
	2	24V _{VAL/OUT}	Load voltage supply (valves/outputs)
	3	0V _{EL/SEN}	Operating voltage supply (electronics, sensors/inputs)
	4	C/Q	Data communication
	5	0V _{VAL/OUT}	Load voltage supply (valves/outputs)

System overview – IO-Link

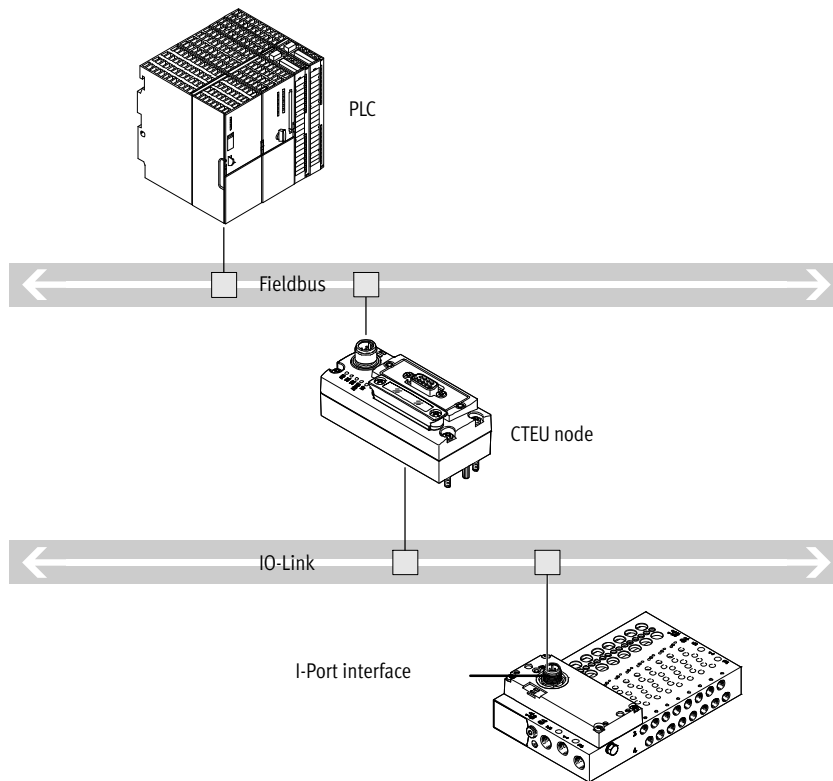

- Communication with the higher-order controller via fieldbus
- Use a bus node CTEU compatible with the fieldbus protocol
- Up to 64 inputs/outputs (solenoid coils), depending on the valve terminal
- No preprocessing

Valve terminals VTUG, I-Port interface/IO-Link

Technical data – I-Port interface/IO-Link

Dimensions

Download CAD data → www.festo.com

I-Port interface, outlet on top

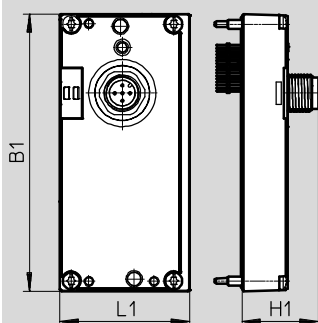

- Note
Dimensions of the manifold rail with electrical connection → page 162

I-Port interface, outlet on the side

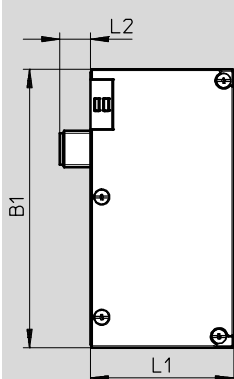

- Note
Dimensions of the manifold rail with electrical connection → page 162

Type	Outlet on top			Outlet on the side		
	B1	L1	H1	B1	L1	L2
VAEM-L1-S-...	91	42.5	25	91.5	47.1	10

Ordering data

	Description	Part No.	Type
Electrical interface for I-Port interface/IO-Link, outlet on top			
	Actuation of up to 8 double solenoid valve positions	573384	VAEM-L1-S-8-PT
	Actuation of up to 16 double solenoid valve positions	573939	VAEM-L1-S-16-PT
	Actuation of up to 24 double solenoid valve positions	573940	VAEM-L1-S-24-PT
Electrical interface for I-Port interface/IO-Link, outlet on the side			
	Actuation of up to 8 double solenoid valve positions	574207	VAEM-L1-S-8-PTL
	Actuation of up to 16 double solenoid valve positions	574208	VAEM-L1-S-16-PTL
	Actuation of up to 24 double solenoid valve positions	574209	VAEM-L1-S-24-PTL
Connection technology for IO-Link			
	T-adapter M12, 5-pin for IO-Link and load supply	171175	FB-TA-M12-5POL
	Straight plug connector, M12, 5-pin, for T-adapter FB-TA	175487	SEA-M12-5GS-PG7
Inscription label for I-Port interface/IO-Link			
	40 pieces in frame	565306	ASLR-C-E4

Valve terminals VTUG, electrical connection box CAPC

Technical data – CAPC

Function

The electrical connection box CAPC enables decentralised installation of bus nodes CTEU on a valve terminal or input modules with I-Port interface.

Area of application

- M12 connection technology (two interfaces)
- Enables the installation of valve terminals or other devices over a distance of 20 metres
- By using the accessory CAFM the sub-base can be installed on an H-rail



General technical data		
Type		CAPC-F1-E-M12
Dimensions W x L x H	[mm]	50 x 148 x 28
Fieldbus interface		2x M12 socket, 5-pin
Operating voltage range	[V DC]	18 ... 30
Max. power supply	[A]	2
Nominal operating voltage	[V DC]	24
Product weight	[g]	85
Cable length	[m]	20

Materials	
Housing	PA reinforced
Note on materials	RoHS compliant

Operating and environmental conditions	
Degree of protection to EN 60529	IP65, IP67
Ambient temperature	[°C] -5 ... +50
Storage temperature	[°C] -20 ... +70
Corrosion resistance class CRC ¹⁾	2
CE mark (see declaration of conformity) ²⁾	To EU EMC Directive

- 1) Corrosion resistance class CRC 2 to Festo standard FN 940070
Moderate corrosion stress. Indoor applications in which condensation may occur. External visible parts with primarily decorative requirements for the surface and which are in direct contact with the ambient atmosphere typical for industrial applications.
- 2) For information about the applicability of the component see the manufacturer's EC declaration of conformity at: www.festo.com/sp → Certificates.
If the component is subject to restrictions on usage in residential, office or commercial environments or small businesses, further measures to reduce the emitted interference may be necessary.

Pin allocation for power supply/IO-Link interfaces			
	Pin	Allocation	Description
	1	24V _{EL/SEN}	Operating voltage supply (electronics, sensors/inputs)
	2	24V _{VAL/OUT}	Load voltage supply (valves/outputs)
	3	0V _{EL/SEN}	Operating voltage supply (electronics, sensors/inputs)
	4	C/Q	Data communication
	5	0V _{VAL/OUT}	Load voltage supply (valves/outputs)
			Housing, FE

Valve terminals VTUG, electrical connection box CAPC

Technical data – CAPC

Dimensions

Download CAD data → www.festo.com

CAPC

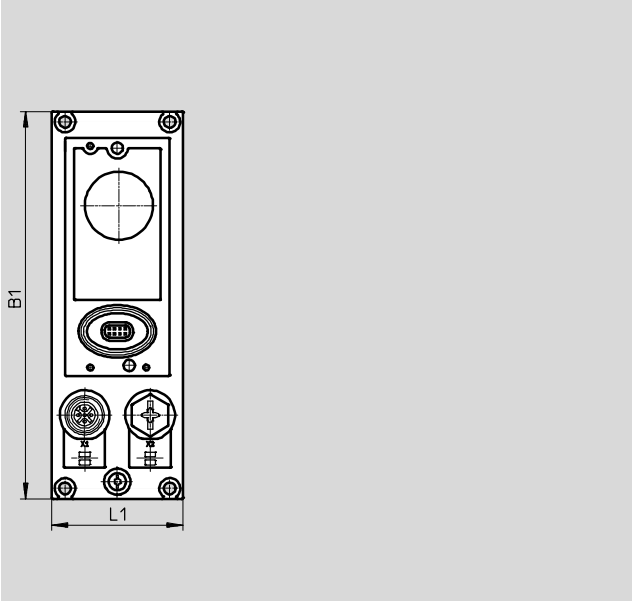

CAPC with mounted bus node CTEU-CO

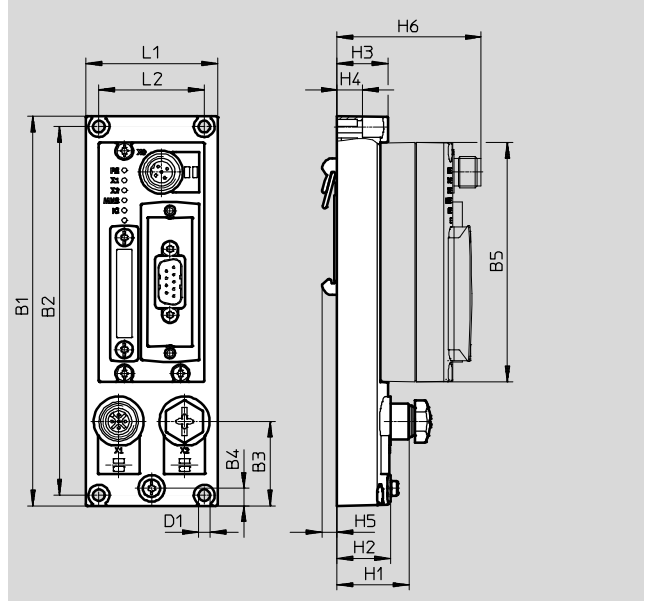

Type	B1	B2	B3	B4	B5	D1Ø	H1	H2	H3	H4	H5	H6	L1	L2
CAPC	148	140	32	6.6	91	4.4	27.3	20.3	19.3	9.6	5.7	54.8	50	40

Ordering data

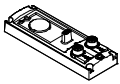
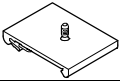
		Part No.	Type
Electrical connection box			
	For connecting a second device with I-Port interface	570042	CAPC-F1-E-M12
H-rail mounting			
	For electrical connection box CAPC	570043	CAF-M-F1-H

Valve terminals VTUG with interlock

Technical data – Interlock

FESTO

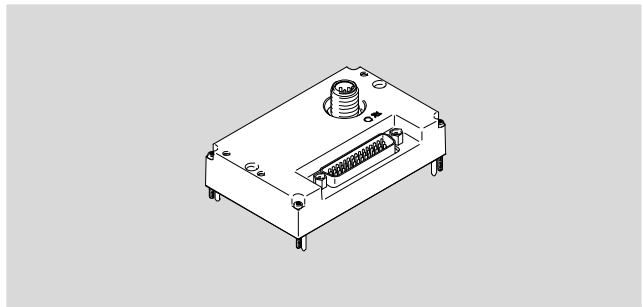

Interlock

The interlock function enables the first 16 solenoid coils to be individually supplied externally.

This guarantees the safety-related release of these valves.

The interlock interface is established via external contacts for a single-pin connection or via safety output terminals for a double-pin connection.

General technical data

Communication types	I-Port/IO-Link		
Number of valve positions	4...24		
Max. number of solenoid coils	48		
Number of interlock solenoid coils	16		
Number of inputs for reading back voltage	18 (16x interlock + 2 group supply)		
Mounting position	Any		
Nominal flow rate	[l/min]	330	
Product weight	[g]	80	
Residual ripple	[V _{SS}]	4	
Baud rate	COM3	[kbps]	230.4
	COM2	[kbps]	38.4
IO-Link	Protocol	V1.0	
	Connection technology	M12, A-coded	
	Port type	Type B	
	Number of ports	1	
	Process data width OUT	6 bytes	
	Process data width IN	4 bytes	
	Minimum cycle time	11.5 ms (2.3 ms per frame = 2 bytes of user data)	
Corrosion resistance class CRC ¹⁾	2		

1) Corrosion resistance class CRC 2 to Festo standard FN 940070

Moderate corrosion stress. Indoor applications in which condensation may occur. External visible parts with primarily decorative requirements for the surface and which are in direct contact with the ambient atmosphere typical for industrial applications.

Valve terminals VTUG with interlock

Technical data – Interlock

Interlock interface

Single-pin interlock interface

- The interlock interface is established via external positive switching contacts or single-pin switching safety terminals
- 16 solenoid coils can be actuated via the interlock (Vn+)
- Solenoid coils that do not require interlock actuation can be supplied directly with 24 V from pins 1 ... 3
- Application of the respective input voltage is reported via the fieldbus as a process image

Double-pin interlock interface

- The interlock interface is established via external positive-negative switching safety terminals
- The solenoid coils of the interlock valves are actuated via the corresponding pins in the sub-D plug connector (pins 7 ... 38)
- The solenoid coils that do not require interlock actuation can be supplied directly with 24 V (e.g. from pins 1 ... 3)
- Any difference in potential between Vn- and 0 VVAL/OUT must be below 5 V

Sample circuit diagram for a single-pin interlock interface

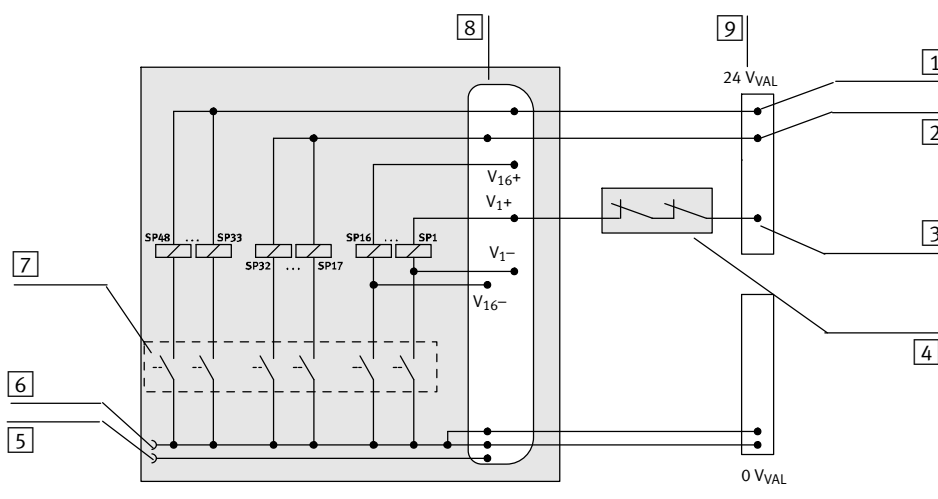

- 1 Power supply V+, solenoid coils 33 48 (no interlock)
- 2 Power supply V+, solenoid coils 17 32 (no interlock)
- 3 Actuation Vn+ (via interlock)
- 4 Interlock contacts of the output terminal
- 5 I-Port connection pin 2, 24 VVAL/OUT (PL), load voltage supply
- 6 I-Port connection pin 5, 0 VVAL/OUT (PL), load voltage supply
- 7 Driver, actuated via fieldbus/I-Port
- 8 Interlock Sub-D connection
- 9 Power supply (interlock)

Sample circuit diagram for a double-pin interlock interface

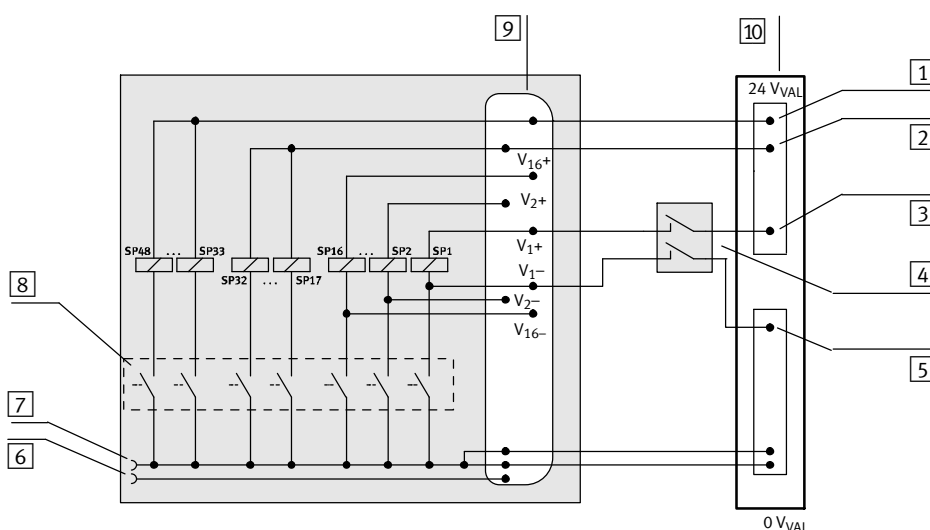

- 1 Power supply V+, solenoid coils 33 48 (no interlock)
- 2 Power supply V+, solenoid coils 17 32 (no interlock)
- 3 Actuation Vn+ (via interlock)
- 4 Interlock contacts of the output terminal
- 5 Actuation Vn- (via interlock)
- 6 I-Port connection pin 2, 24 VVAL/OUT (PL), load voltage supply
- 7 I-Port connection pin 5, 0 VVAL/OUT (PL), load voltage supply
- 8 Driver, actuated via fieldbus/I-Port
- 9 Interlock Sub-D connection
- 10 Power supply (interlock)

Valve terminals VTUG with interlock

Technical data – Interlock

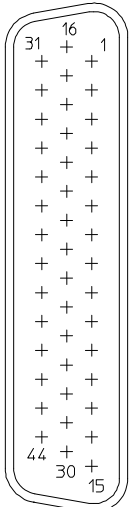
Pin allocation – Interlock									
	Pin	Coil	Signal	Pin	Coil	Signal	Pin	Coil	Signal
	1	-	24 V _{VAL/OUT}	16	5	V5-	31	13	V13+
	2	-	24 V _{VAL/OUT}	17	6	V6+	32	13	V13-
	3	-	24 V _{VAL/OUT}	18	6	V6-	33	14	V14+
	4	1 ... 48	0 V _{VAL/OUT}	19	7	V7+	34	14	V14-
	5	1 ... 48	0 V _{VAL/OUT}	20	7	V7-	35	15	V15+
	6	1 ... 48	0 V _{VAL/OUT}	21	8	V8+	36	15	V15-
	7	1	V1+	22	8	V8-	37	16	V16+
	8	1	V1-	23	9	V9+	38	16	V16-
	9	2	V2+	24	9	V9-	39	17 ... 32	V17 ... 32+
	10	2	V2-	25	10	V10+	40	33 ... 48	V33 ... 48+
	11	3	V3+	26	10	V10-	41	1 ... 48	0 V _{VAL/OUT}
	12	3	V3-	27	11	V11+	42	1 ... 48	0 V _{VAL/OUT}
	13	4	V4+	28	11	V11-	43	1 ... 48	0 V _{VAL/OUT}
	14	4	V4-	29	12	V12+	44	-	n.c.
	15	5	V5+	30	12	V12-	Housing		FE

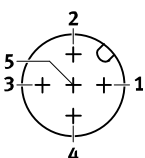
Pin allocation – I-Port interface/IO-Link			
	Pin	Allocation	Description
	1	24V _{EL/SEN}	Operating voltage supply (electronics, sensors/inputs)
	2	24V _{VAL/OUT}	Load voltage supply (valves/outputs)
	3	0V _{EL/SEN}	Operating voltage supply (electronics, sensors/inputs)
	4	C/Q	Data communication
	5	0V _{VAL/OUT}	Load voltage supply (valves/outputs)
	Housing, FE		

Dimensions Download CAD data → www.festo.com

I-Port interface with interlock, outlet on top

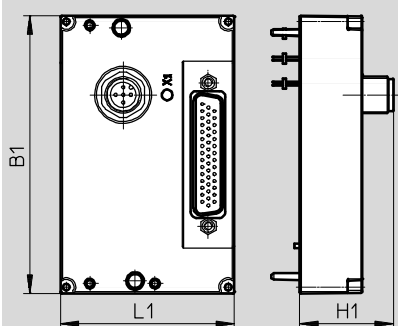







 Note

Dimensions of the manifold rail with electrical connection → page 162

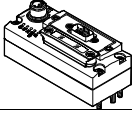
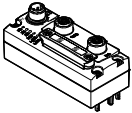
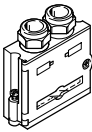
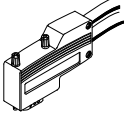
Type	Outlet on top		
	B1	L1	H1
VAEM-L1-S-24-PTK	91	57	30.8

Valve terminals VTUG with multi-pin plug and fieldbus connection

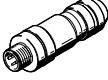
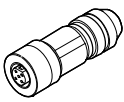
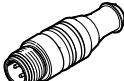



Accessories – Valve terminal

Ordering data – CTEU			
	Description	Part No.	Type
Bus node			
	CANopen bus node	570038	CTEU-CO
	CC-Link bus node	1544198	CTEU-CC
	PROFIBUS bus node	570040	CTEU-PB
	DeviceNet bus node	570039	CTEU-DN
	EtherCAT bus node	572556	CTEU-EC
Bus connection			
	Sub-D plug connector, straight	For CANopen	532219 FBS-SUB-9-BU-2x5POL-B
		For CC-Link	532220 FBS-SUB-9-GS-2x4POL-B
		For PROFIBUS	532216 FBS-SUB-9-GS-DP-B
	Sub-D plug connector, angled, 9-pin	For CANopen	533783 FBS-SUB-9-WS-CO-K
		For PROFIBUS	533780 FBS-SUB-9-WS-PB-K
	M12x1, 5-pin	A-coded, for CANopen	525632 FBA-2-M12-5POL
		B-coded, for PROFIBUS	533118 FBA-2-M12-5POL-RK
	For 5-pin terminal strip for CANopen	525634	FBA-1-SL-5POL
	Terminal strip, 5-pin, for DeviceNet/CANopen	525635	FBSD-KL-2x5POL
	Screw terminal for CC-Link	197962	FBA-1-KL-5POL
	Straight plug connector, M12x1	5-pin, for CANopen	175380 FBS-M12-5GS-PG9
		4-pin, D-coded for EtherCAT	543109 NECU-M-S-D12G4-C2-ET
		5-pin, compatible with FBA-2-M12-5POL-RK for PROFIBUS	1066354 NECU-M-S-B12G5-C2-PB
	Straight socket, M12x1, 5-pin, for assembling a connecting cable compatible with FBA-2-M12-5POL-RK for PROFIBUS	1067905	NECU-M-B12G5-C2-PB
	Terminating resistor, M12, B-coded for PROFIBUS	1072128	CACR-S-B12G5-220-PB
Plug socket			
	For power supply, M12x1, 5-pin, B-coded for CANopen/DeviceNet	538999	NTSD-GD-9-M12-5POL-RK
	For power supply, M12x1, 5-pin for CC-Link, PROFIBUS, EtherCAT	18324	FBSD-GD-9-5POL
Inscription label			
	For bus node	565306	ASLR-C-E4

Valve terminals VTUG with multi-pin plug and fieldbus connection

FESTO

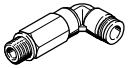
Accessories – Valve terminal

Ordering data						
	Description		Part No.	Type	PU ¹⁾	
Push-in fitting, straight Technical data → Internet: qsm						
	M5 thread	For tubing Ø 3 mm	–	★ 153313	QSM-M5-3-I	10
		Round releasing ring		133003	QSM-M5-3-I-R	10
	M5 thread	For tubing Ø 4 mm	–	★ 153315	QSM-M5-4-I	10
		Round releasing ring		133004	QSM-M5-4-I-R	10
	M7 thread	For tubing Ø 4 mm	–	★ 153319	QSM-M7-4-I	10
		Round releasing ring		133005	QSM-M5-6-I-R	10
	G1/8 thread	For tubing Ø 4 mm	–	★ 186106	QS-G1/8-4-I	10
		For tubing Ø 6 mm	–	★ 186107	QS-G1/8-6-I	10
		For tubing Ø 8 mm	–	★ 186109	QS-G1/8-8-I	10
		For tubing Ø 10 mm	–	★ 190647	QS-1/8-10-I	10
	G1/4 thread	For tubing Ø 8 mm	–	132280	QS-B-1/4-8-I	1
		–		★ 153016	QS-1/4-8-I	10
		For tubing Ø 10 mm	–	132842	QS-B-1/4-10-I	1
		–		★ 153018	QS-1/4-10-I	10
	G3/8 thread	For tubing Ø 12 mm	–	★ 190649	QS-1/4-12-I	10
		For tubing Ø 8 mm	–	130681	QS-3/8-8-50	50
		For tubing Ø 10 mm	–	130682	QS-3/8-10-50	50
		For tubing Ø 12 mm	–	130683	QS-3/8-12-20	20
	For tubing Ø 16 mm	–	★ 164957	QS-3/8-16	1	
Push-in fitting, angled Technical data → Internet: qsl						
	M5 thread	For tubing Ø 3 mm	–	★ 153331	QSML-M5-3	10
		For tubing Ø 4 mm	–	★ 153333	QSML-M5-4	10
	M7 thread	For tubing Ø 4 mm	–	★ 186352	QSML-M7-4	10
	G1/8 thread	For tubing Ø 6 mm	–	130765	QSML-1/8-6-100	100
		For tubing Ø 6 mm	–	★ 186117	QSL-G1/8-6	10
		For tubing Ø 8 mm	–	★ 186119	QSL-G1/8-8	10
	G1/4 thread	For tubing Ø 10 mm	–	★ 190658	QSL-1/8-10	10
		For tubing Ø 8 mm	–	132220	QSL-B-1/4-8	1
		For tubing Ø 8 mm	–	130732	QSL-1/4-8-50	50
		For tubing Ø 10 mm	–	132817	QSL-B-1/4-10	1
		For tubing Ø 10 mm	–	130733	QSL-1/4-10-50	50
	For tubing Ø 12 mm	–	130734	QSL-1/4-12-20	20	
Push-in fitting, long, angled Technical data → Internet: qsl						
	M5 thread	For tubing Ø 3 mm	–	130838	QSMML-M5-3	10
		For tubing Ø 4 mm	–	153339	QSMML-M5-4	10
	M7 thread	For tubing Ø 4 mm	–	186354	QSMML-M7-4	10
	G1/8 thread	For tubing Ø 6 mm	–	186128	QSLL-G1/8-6	10
		For tubing Ø 8 mm	–	186130	QSLL-G1/8-8	10
Blanking plug Technical data → Internet: b						
	For M5 thread			★ 174308	B-M5-B	10
	For M7 thread			★ 174309	B-M7	10
	For G1/8 thread			★ 3568	B-1/8	10
	For G1/4 thread			★ 3569	B-1/4	10
	For G1/8 thread			196720	CDVI5.0-B-G1/8	1
	For G3/8 thread			196712	CDVI5.0-B-G3/8	1
	For G1/4 thread			8035644	CDVI5.0-B-G1/4	1

1) Packaging unit.









Festo core product range

- ★ Ready for dispatch from the Festo factory in 24 hours
- ☆ Ready for dispatch in 5 days maximum from stock

Valve terminals VTUG with multi-pin plug and fieldbus connection

FESTO

Accessories – Valve terminal

Ordering data					
Description		Part No.	Type	PU ¹⁾	
Silencer Technical data → Internet: amte					
	For M3 thread	1231120	AMTE-M-LH-M3	20	
	For M5 thread	★ 1205858	AMTE-M-LH-M5	20	
	For M7 thread	161418	UC-M7	1	
	For G1/8 thread	High flow rate	★ 2307	U-1/8	1
		Lower flow rate	161419	UC-1/8	1
	For G1/4 thread	High flow rate	★ 2316	U-1/4	1
		Lower flow rate	534223	U-1/4-20	20
			165004	UC-1/4	1
534220	UC-1/4-20	20			
Blanking plate					
	Vacant position width 10 mm	573422	VABB-L1-10-T	1	
	Vacant position width 14 mm	573488	VABB-L1-14-T	1	
	Vacant position width 18 mm	8004897	VABB-L1-18-T	1	
Supply plate					
	Supply ports 1, 3, 5, width 10 mm	573924	VABF-L1-10-P3A4-M7-T1	1	
	Supply ports 1, 3, 5, width 14 mm	573925	VABF-L1-14-P3A4-G18-T1	1	
	Supply ports 1, 3, 5, width 18 mm	8004898	VABF-L1-18-P3A4-G14-T1	1	
Separator					
	For manifold rail, size 10, M5/M7	For sub-base valves	569994	VABD-6-B	1
		For semi in-line valves	569995	VABD-8-B	1
	For all manifold rails, size 14, G1/8		569996	VABD-10-B	1
	For all manifold rails, size 18, G1/4		569997	VABD-12-B	1
Cover cap for manual override					
	Covered	540898	VMPA-HBV-B	10	
	Non-detenting	540897	VMPA-HBT-B	10	
	Detenting (without accessories)	8002234	VAMC-L1-CD	10	
Inscription label holder Technical data → Internet: aslr					
	Holder for an inscription label and covering the mounting screw and manual override	570818	ASLR-D-L1	10	





Festo core product range

- ★ Ready for dispatch from the Festo factory in 24 hours
- ☆ Ready for dispatch in 5 days maximum from stock

Valve terminals VTUG with multi-pin plug and fieldbus connection

FESTO

Accessories – Valve terminal



Ordering data						
	Description		Part No.	Type	PU ¹⁾	
Check valve						
	For manifold rails VABM-L1-10...	For blocking the flow in the event of back pressure in duct 3 and 5	8047364	VABF-L1-10H-H2	10	
	For manifold rails VABM-L1-14...	For blocking the flow in the event of back pressure in duct 3 and 5	8047365	VABF-L1-14-H2	10	
Flow restrictor						
	For manifold rails VABM-L1-10...	For setting the flow rate during pressurisation and exhausting (for threaded connection M5)	Nominal size: 0.5 mm	8025709	VFFG-T-M5-5	10
			Nominal size: 0.6 mm	8025710	VFFG-T-M5-6	10
			Nominal size: 0.7 mm	8025711	VFFG-T-M5-7	10
			Nominal size: 0.85 mm	8025712	VFFG-T-M5-8	10
			Nominal size: 1.05 mm	8025713	VFFG-T-M5-10	10
			Nominal size: 1.2 mm	8025714	VFFG-T-M5-12	10
			Nominal size: 1.55 mm	8025715	VFFG-T-M5-15	10
		For setting the flow rate during pressurisation and exhausting (for Ø 4 mm)	Nominal size: 0.5 mm	8047346	VFFG-T-F4-5	10
			Nominal size: 0.6 mm	8047347	VFFG-T-F4-6	10
			Nominal size: 0.7 mm	8047348	VFFG-T-F4-7	10
			Nominal size: 0.85 mm	8047349	VFFG-T-F4-8	10
			Nominal size: 1.05 mm	8047350	VFFG-T-F4-10	10
			Nominal size: 1.2 mm	8047351	VFFG-T-F4-12	10
			Nominal size: 1.55 mm	8047352	VFFG-T-F4-15	10
For manifold rails VABM-L1-14...	For setting the flow rate during pressurisation and exhausting (for Ø 5.8 mm)	Nominal size: 0.7 mm	8047353	VFFG-T-F6-7	10	
		Nominal size: 0.85 mm	8047354	VFFG-T-F6-8	10	
		Nominal size: 1.05 mm	8047355	VFFG-T-F6-10	10	
		Nominal size: 1.15 mm	8047356	VFFG-T-F6-11	10	
		Nominal size: 1.4 mm	8047357	VFFG-T-F6-14	10	
		Nominal size: 1.6 mm	8047358	VFFG-T-F6-16	10	
		Nominal size: 1.8 mm	8047359	VFFG-T-F6-18	10	
Restrictor set						
	For manifold rails VABM-L1-10...	Two of each size, for threaded connection M5	8025716	VFFG-T-M5-A-V1	14	
		Two of each size, for Ø 4 mm	8062200	VFFG-T-F4-A-V1	14	
	For manifold rails VABM-L1-14...	Two of each size, for Ø 5.8 mm	8062201	VFFG-T-F6-A-V1	14	

1) Packaging unit.

Valve terminals VTUG with multi-pin plug and fieldbus connection

FESTO

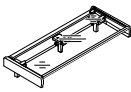
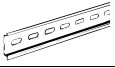
Accessories – Valve terminal

Ordering data					
Description		Part No.	Type		
Inscription label holder for valve terminal					
	Size 10	For 4 valve positions	573453	ASCF-H-L1-10-4V	
		For 5 valve positions	573454	ASCF-H-L1-10-5V	
		For 6 valve positions	573455	ASCF-H-L1-10-6V	
		For 7 valve positions	573456	ASCF-H-L1-10-7V	
		For 8 valve positions	573457	ASCF-H-L1-10-8V	
		For 9 valve positions	573458	ASCF-H-L1-10-9V	
		For 10 valve positions	573459	ASCF-H-L1-10-10V	
		For 12 valve positions	573460	ASCF-H-L1-10-12V	
		For 16 valve positions	573461	ASCF-H-L1-10-16V	
		For 20 valve positions	573462	ASCF-H-L1-10-20V	
			For 24 valve positions	573463	ASCF-H-L1-10-24V
		Size 14	For 4 valve positions	573511	ASCF-H-L1-14-4V
			For 5 valve positions	573512	ASCF-H-L1-14-5V
			For 6 valve positions	573513	ASCF-H-L1-14-6V
			For 7 valve positions	573514	ASCF-H-L1-14-7V
			For 8 valve positions	573515	ASCF-H-L1-14-8V
			For 9 valve positions	573516	ASCF-H-L1-14-9V
			For 10 valve positions	573518	ASCF-H-L1-14-10V
			For 12 valve positions	573519	ASCF-H-L1-14-12V
			For 16 valve positions	573520	ASCF-H-L1-14-16V
			For 20 valve positions	573521	ASCF-H-L1-14-20V
			For 24 valve positions	573522	ASCF-H-L1-14-24V
		Size 18	For 4 valve positions	8004928	ASCF-H-L1-18-4V
			For 5 valve positions	8004929	ASCF-H-L1-18-5V
			For 6 valve positions	8004930	ASCF-H-L1-18-6V
			For 7 valve positions	8004931	ASCF-H-L1-18-7V
			For 8 valve positions	8004932	ASCF-H-L1-18-8V
			For 9 valve positions	8004933	ASCF-H-L1-18-9V
			For 10 valve positions	8004934	ASCF-H-L1-18-10V
			For 12 valve positions	8004935	ASCF-H-L1-18-12V
	For 16 valve positions		8004936	ASCF-H-L1-18-16V	
	For 20 valve positions		8004937	ASCF-H-L1-18-20V	
		For 24 valve positions	8004938	ASCF-H-L1-18-24V	
H-rail Technical data → Internet: nrh					
	To EN 60715, 35 x 7.5 (WxH)	Length: 2 m	35430	NRH-35-2000	
H-rail mounting Technical data → Internet: vame					
	Use the following screws for mounting: Size 10: DIN 912: M4x30 Size 14: DIN 912: M4x40 Size 18: DIN 912: M5x50		★ 569998	VAME-T-M4	

Festo core product range

- ★ Ready for dispatch from the Festo factory in 24 hours
- ☆ Ready for dispatch in 5 days maximum from stock