

Solenoid valves MN1H-MS, brass version

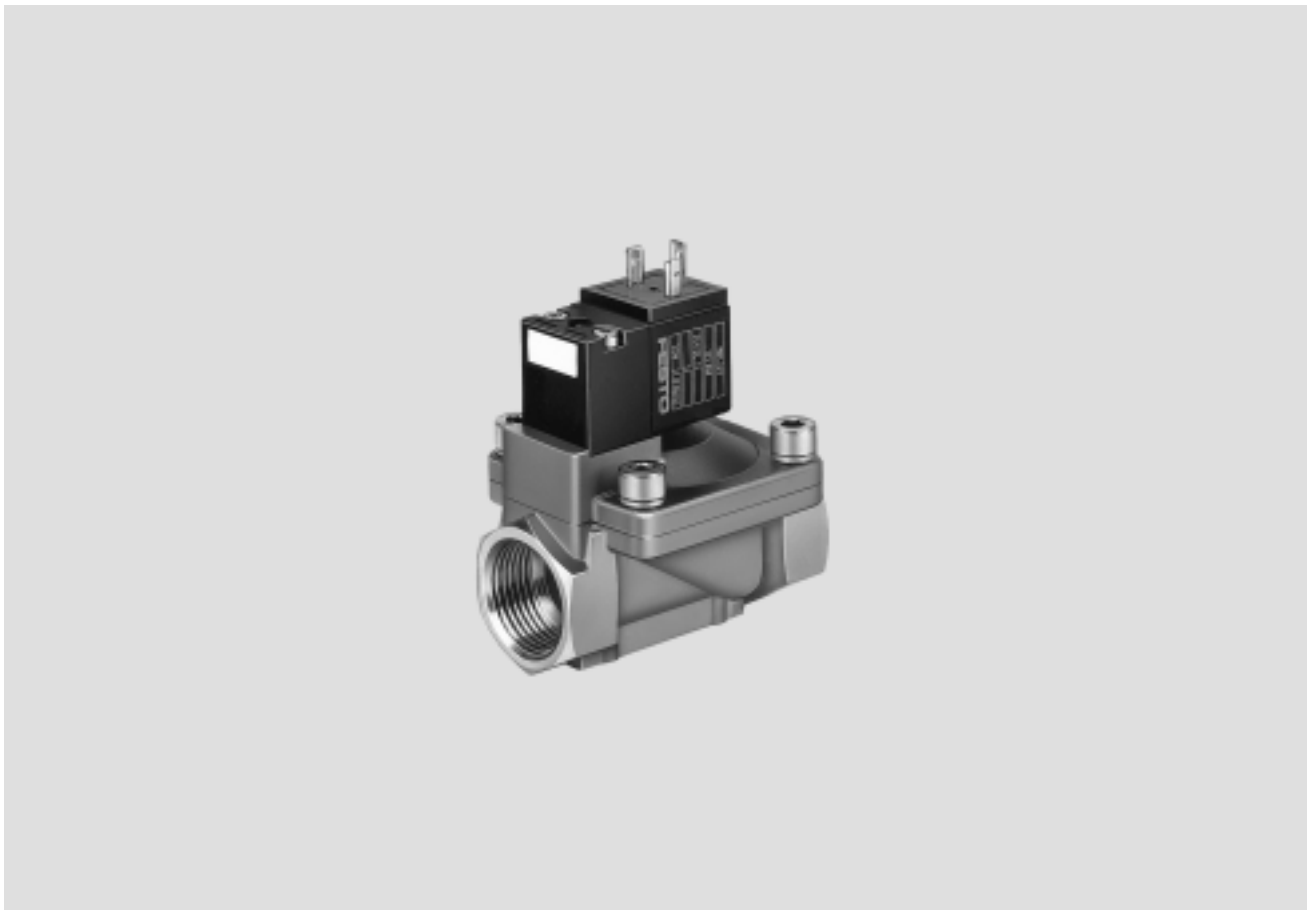

Solenoid valves MN1H-MS, brass design

Key features





Function

When the solenoid is energised, the valve is actuated.

The valve MN1H-2-1½-MS is equipped with adjustable closing cushioning.

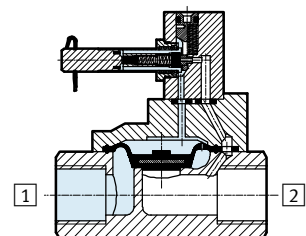
- 1 Supply port
- 2 Working or outlet line



-  - Note

The diaphragm opens briefly when pressure is connected.

Solenoid valves MN1H-MS, brass design

Type codes

MN1H - 2 - 1/4 - MS

Type

MN1H	Single pilot, for N1 solenoid coil
------	------------------------------------

Valve function

2	2/2-way valve
---	---------------

Connection, valve

1/4	G1/4
3/8	G3/8
1/2	G1/2
3/4	G3/4
1	G1
1 1/2	G1 1/2

Housing material

MS	Brass
----	-------

Solenoid valves MN1H-MS, brass design

FESTO

Technical data

Function

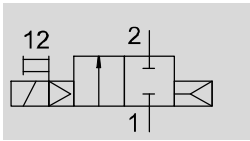

-  - Flow rate
2000 ... 30500 l/min

-  - Voltage
24 V DC
110, 230 V AC



General technical data							
Connection, valve		G1/4	G3/8	G1/2	G3/4	G1	G1 1/2
Valve function		2/2-way, single pilot					
Constructional design		Diaphragm valve					
Sealing principle		Soft					
Actuation type		Electrical					
Type of reset		Air spring					
Type of pilot control		Piloted					
Direction of flow		Non-reversible					
Exhaust function		No flow control					
Manual override		Non-detenting, detenting via accessory					
Type of mounting		In-line installation					
Mounting position		Any					
Nominal size [mm]		13	13	13	20	25	40
Standard nominal flow rate [l/min]		2000	2900	3100	10000	11500	30500
Product weight [g]		450	450	400	1100	1000	2600
Materials		Housing					
		Brass					
Diaphragm		Nitrile rubber					
Max. tightening torque ¹⁾ [Nm]		35	60	105	200	380	850

1) Ports 1 and 2

-  - Note: This product conforms to ISO 1179-1 and to ISO 228-1

Operating and environmental conditions	
Medium	Filtered compressed air, lubricated or unlubricated
Note about operating/pilot medium	Lubricated operation possible (subsequently required for further operation)
Medium pressure [bar]	0.5 ... 10
Ambient temperature [°C]	-10 ... +60
Temperature of medium [°C]	-10 ... +60

Valve response times		
Connection, valve	On	Off
G1/4	30	100
G3/8	30	100
G1/2	30	100
G3/4	120	180
G1	120	180
G1 1/2	230 ... 440	300 ... 1000

Materials		
Solenoid valves		Material number
Housing	Brass	
Screws	High-alloy stainless steel	1.4301

Solenoid valves MN1H-MS, brass design

Technical data

Electrical data			
N1 solenoid coil			
Electrical connection		Plug, square design to EN 175301-803, type A	
Operating voltage	D.C. voltage	[V DC]	24
	A.C. voltage	[V AC]	110/230 (50 ... 60 Hz)
Coil characteristics	D.C. voltage	[W]	2.5
	A.C. voltage	[VA]	Pull: 5 Hold: 3.7
Protection class to EN 60 529		IP65 (with plug socket)	

Dimensions Download CAD data → www.festo.com

2/2-way valve

1 Wiring at plug socket to EN 175301-803, type A
 2 Manual override, detenting
 3 Manual override, resetting
 4 Location for inscription labels IBS-9x20
 5 Mounting bracket HRM-...

Connection, valve D	B	D1	H	H1	H2	L	L1	L2	L3	L4	≙
G $\frac{1}{4}$	48	M4	67	46	15	67	25	21	26.5	20	27
G $\frac{3}{8}$	48	M4	67	46	15	67	25	21	26.5	20	27
G $\frac{1}{2}$	48	M4	67	46	15	67	25	21	26.5	20	27
G $\frac{3}{4}$	70	M6	78	57	23	95	40	27.5	26.5	21.5	41
G1	70	M6	78	57	23	95	40	27.5	26.5	21.5	41
G1 $\frac{1}{2}$	96	M6	91.5	70.5	31.5	140	59.5	38.3	26.5	30	58

Note: This product conforms to ISO 1179-1 and to ISO 228-1

Ordering data

Circuit symbol	Pneumatic connection	Part No.	Type
	G $\frac{1}{4}$	161725	MN1H-2- $\frac{1}{4}$ -MS
	G $\frac{3}{8}$	161727	MN1H-2- $\frac{3}{8}$ -MS
	G $\frac{1}{2}$	161728	MN1H-2- $\frac{1}{2}$ -MS
	G $\frac{3}{4}$	161731	MN1H-2- $\frac{3}{4}$ -MS
	G1	161732	MN1H-2-1-MS
	G1 $\frac{1}{2}$	161734	MN1H-2-1 $\frac{1}{2}$ -MS

Solenoid valves MN1H-MS, brass design

Accessories

Mounting bracket HRM

Material:
Galvanised steel

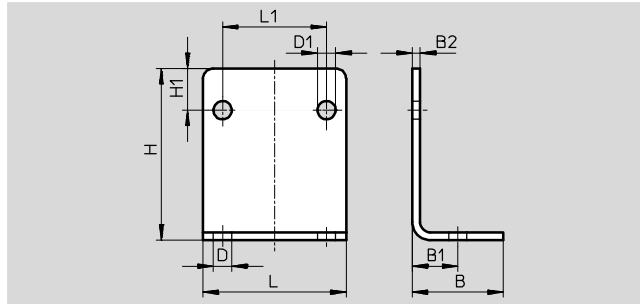



Dimensions and ordering data												
For valve with pneumatic connection	B	B1	B2	D Ø	D1 Ø	H	H1	L	L1	Weight [g]	Part No.	Type
G $\frac{1}{4}$... G $\frac{1}{2}$	25	12.5	2	6	5	37	10	40	25	39	9769	HRM-1
G $\frac{3}{4}$... G1	35	17.5	3	7	7	66	16	55	40	130	9770	HRM-2
G1 $\frac{1}{2}$	47	23.5	3	9	7	87	23	75	59.5	246	9771	HRM-3

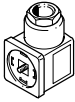
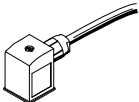
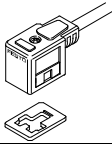

Solenoid valves MN1H-MS, brass design

Accessories

Ordering data – Solenoid coils		Technical data → Internet: msn1g	
	Voltage	Part No.	Type
	24 V DC	123060	MSN1G-24DC-OD
	110 V AC, 50 ... 60 Hz	123061	MSN1W-110AC-OD
	230 V AC, 50 ... 60 Hz	123062	MSN1W-230AC-OD

Ordering data – Plug sockets, connecting cables				Technical data → Internet: mssd-c	
	Voltage	Cable length [m]	Switching status display with LED	Part No.	Type
Plug socket without cable					
	–	–	–	34583	MSSD-C
Plug socket without cable with insulation displacement technology					
	–	–	–	192748	MSSD-C-S-M16
Connecting cables					
	24 V DC	2.5	■	30931	KMC-1-24DC-2,5-LED
	24 V DC	5	■	30933	KMC-1-24DC-5-LED
	24 V DC	10	■	193459	KMC-1-24DC-10-LED
	Up to 230 V	2.5	–	30932	KMC-1-230AC-2,5
	Up to 230 V	5	–	30934	KMC-1-230AC-5

Ordering data – Illuminating seal		Technical data → Internet: mc-ld	
	Voltage	Part No.	Type
	12 ... 24 V DC	19145	MC-LD-12-24DC
	230 V DC/V AC	19146	MC-LD-230AC

Ordering data – General accessories			
		Part No.	Type
Manual override tool			
	For N1 coils	157651	AHB-MD/MF/MV
Inscription labels			
	Scope of delivery 20 labels in frame	18182	IBS-9x20