

Valve terminals type 32 MPA

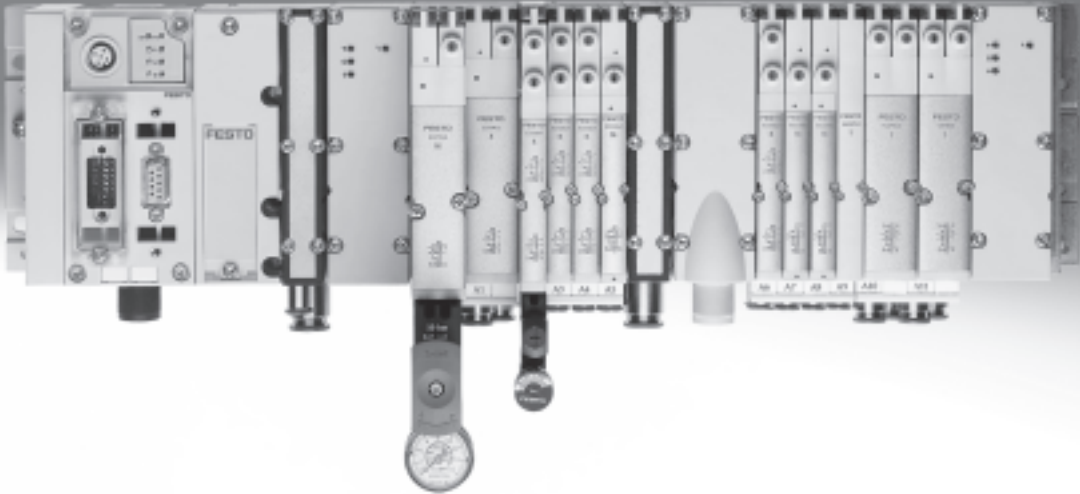

Valve terminals type 32 MPA

Key features

FESTO

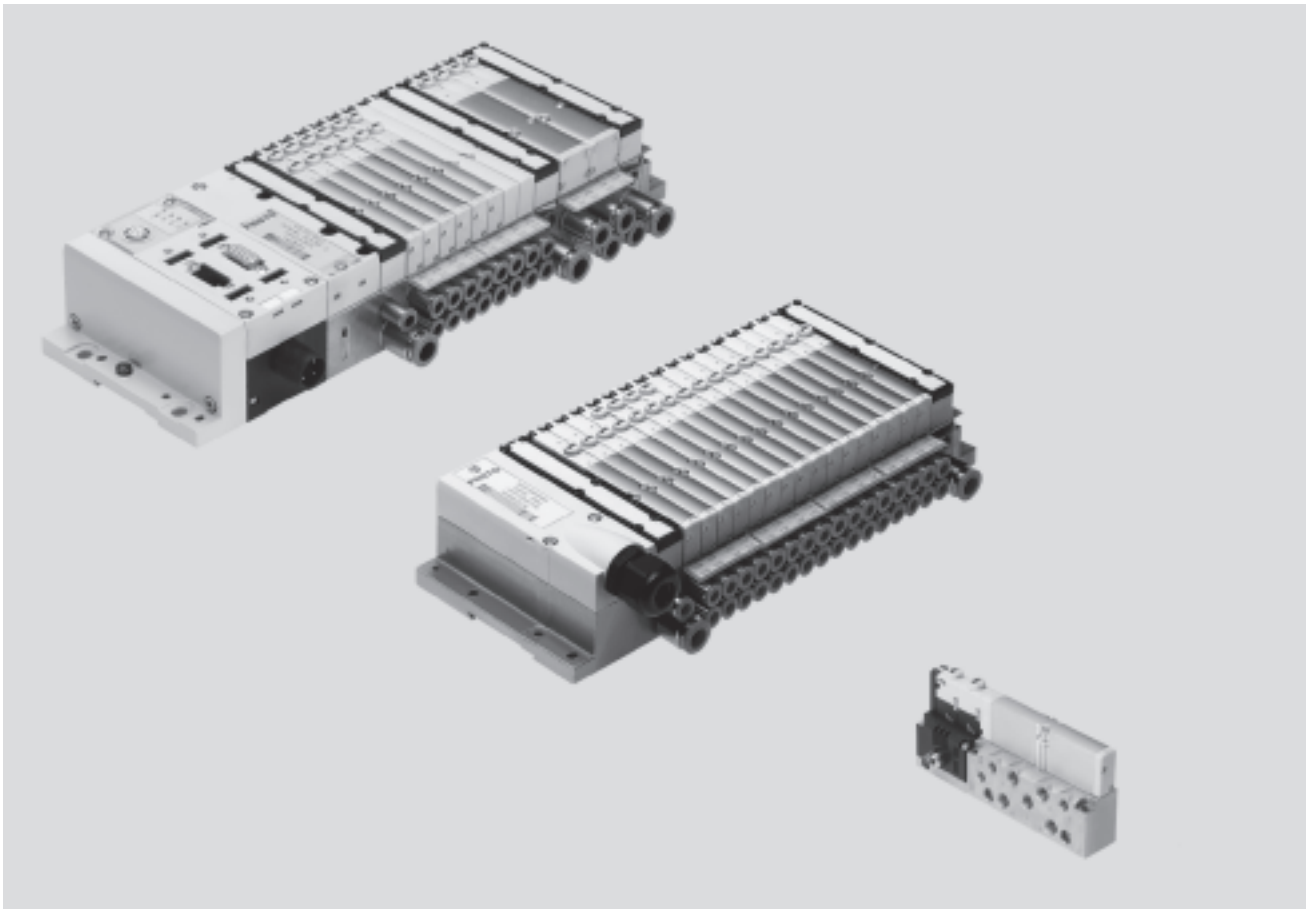

Innovative

- Slim high-performance valves in sturdy metal housing
- MPA1 flow rates up to 360 l/min
- MPA2 flow rates up to 700 l/min
- From the individual valve to the valve terminal with multi-pin plug, AS-interface, CPI and fieldbus connections and control block
- Dream team: fieldbus valve terminal suitable for electrical peripherals CPX. This means:
 - Forward-looking internal communication system for actuation of the valves and CPX modules
 - Diagnostics down to the individual valve
 - Valves can be actuated with or without (standard) isolated electrical circuits

Versatile

- Modular system offering a range of configuration options
- Expandable up to 128 solenoid coils
- Conversion and expansion possible at a later date
- Further manifold blocks can be assembled using just three screws and sturdy separating seals on metal separator plates
- Integration of innovative function modules possible
- Manual regulators, rotatable pressure gauges
- Proportional pressure regulators
- Additional air supply via additional pressure zones using supply plates
- Wide range of pressures –0.9 ... 10 bar
- Wide range of valve functions

Reliable

- Sturdy and durable metal components
 - Valves
 - Manifold blocks
 - Seals
- Fast troubleshooting thanks to LEDs on the valves and diagnostics via fieldbus
- Extensive operating voltage range $\pm 25\%$
- Ease of servicing through replaceable valves and electronics modules
- Manual override either non-detenting, detenting or secured against unauthorised activation (covered)
- Durable, thanks to tried and tested piston spool valves
- Large and durable labelling system, suitable for barcodes

Easy to mount

- Ready-to-install unit, already assembled and tested
- Lower selection, ordering, installation and commissioning costs
- Secure mounting on wall or H-rail mounting

Valve terminals type 32 MPA

Key features

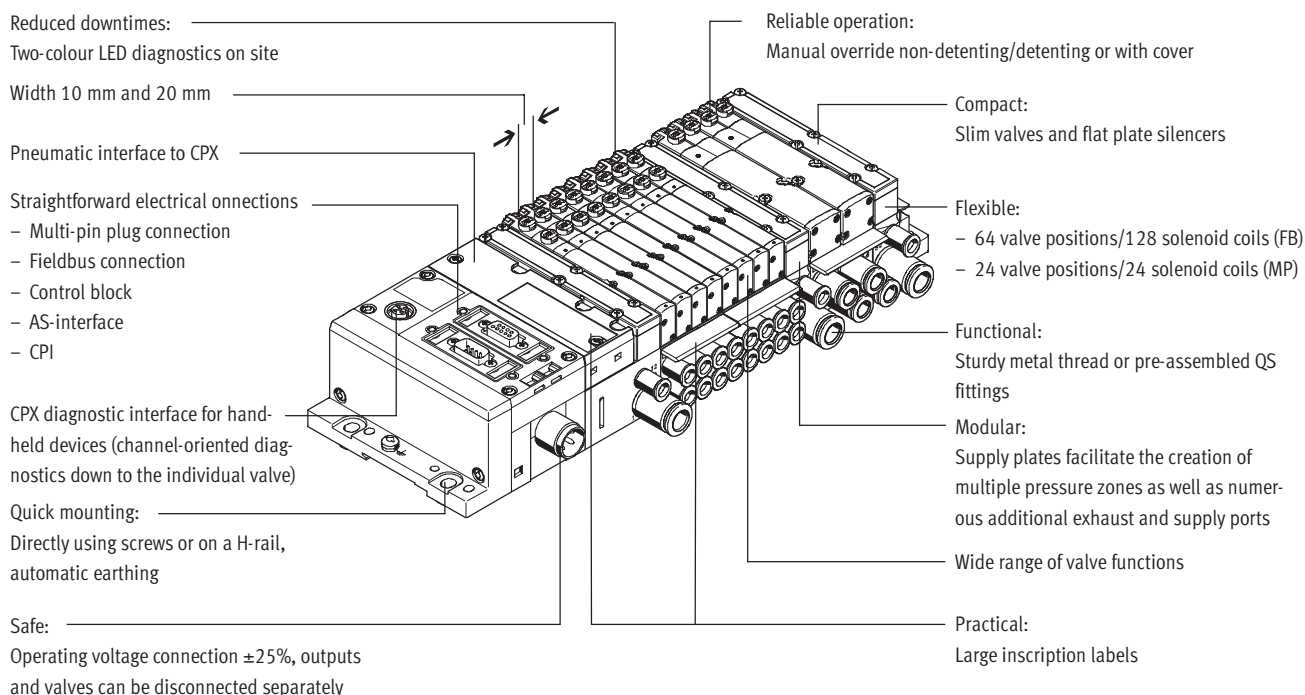

Equipment options

Valve functions

- 5/2-way valve, single solenoid
 - 5/2-way valve, double solenoid
 - 2x 3/2-way valve, normally open
 - 2x 3/2-way valve, normally closed
 - 2x 3/2-way valve, 1x normally open, 1x normally closed
 - 5/3-way valve, mid-position pressurised
 - 5/3-way valve, mid-position closed
 - 5/3-way valve, mid-position exhausted
 - 2x 2/2-way valve, 1x normally closed, 1x normally closed, reversible
 - 2x 2/2-way valve, normally closed
 - 1x 3/2-way valve, normally closed, external compressed air supply
 - 1x 3/2-way valve, normally open, external compressed air supply
 - Manual pressure regulators
 - Proportional pressure regulators
 - Pressure sensor
- All valves have the same compact dimensions with an overall length of 107 mm and a width of 10.5 mm or 21 mm. A height of 55 mm makes them a perfect match for the electrical peripherals CPX.

Special features

- | | | | |
|--|--|---|--|
| <p>Multi-pin terminal</p> <ul style="list-style-type: none"> • Max. 24 valve positions/ max. 24 solenoid coils • Parallel modular valve linking via circuit boards • Electronics module with integrated holding current reduction • Any compressed air supply • Creation of pressure zones | <p>Fieldbus terminal/control block</p> <ul style="list-style-type: none"> • Max. 64 valve positions/ max. 128 solenoid coils • Internal CPX bus system for valve actuation • Module for electrical valve actuation, via separate voltage supply or without electrical isolation • Any compressed air supply • Creation of pressure zones | <p>Individual valve</p> <ul style="list-style-type: none"> • Electrical M8 connection, 4-pin with screw connection • Detachable electronics module with integrated holding current reduction <p>AS-interface</p> <ul style="list-style-type: none"> • 2 to 8 valves, freely configurable (max. 8 solenoid coils) with input feedback | <p>CPI interface</p> <ul style="list-style-type: none"> • Max. 32 valve positions/ max. 32 solenoid coils <p>Combinable</p> <ul style="list-style-type: none"> • MPA1 flow rates up to 360 l/min • MPA2 flow rates up to 700 l/min • MPA1 and MPA2 can be combined on one valve terminal |
|--|--|---|--|

Electrical supply plate

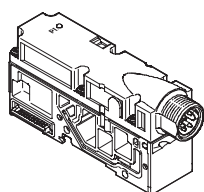

- Increases the maximum number of valve positions possible to 64, with max. 128 solenoid coils
- Creation of isolated, individually disconnectable electrical circuits (voltage zones)
- Greater economy thanks to the higher number of valves/solenoid coils per valve terminal
- Greater safety through individual disconnection of valve groups, for example for EMERGENCY-STOP functions

 Note
The electrical supply plate is available with either an M18 or 7/8" connection.

Valve terminals type 32 MPA

Key features

FESTO

Valve terminal configurator

Online via: → www.festo.com

Selecting an MPA valve terminal using the online catalogue is quick and easy thanks to the convenient valve terminal configurator provided. This makes it much easier to find the right product.

The valve terminals are fully assembled according to your order specifications and are individually tested. This reduces the assembly and installation time to a minimum.

The valve terminal type 32 is ordered using the order code.

Ordering system for type 32

→ Internet: [mpa](#)

Ordering system for CPX

→ Internet: [cpx](#)

2D/3D CAD data

Online via: → www.festo.com

You can request the CAD data for a valve terminal you have configured. To do so, perform the product search as described above. Go to the shopping basket and click on the CAD icon

(compass). On the next page you can generate a 3D preview or request another data format of your choice by e-mail.

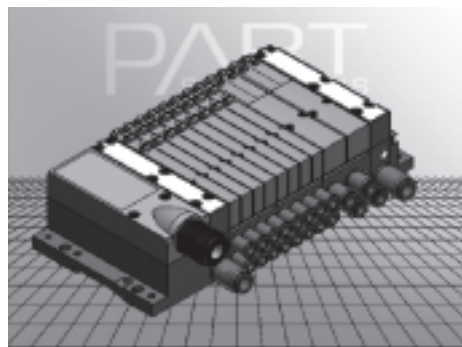

Valve terminals type 32 MPA

Key features

Individual connection

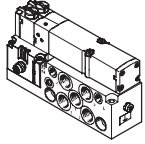

Valves can also be used on individual sub-bases for actuators further away from the valve terminal.

The electrical connection is established using a standard 4-pin M8 plug (EN 60947-5-2).

Multi-pin plug connection

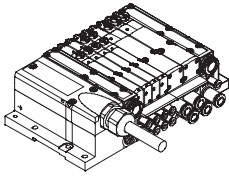

The signal flow from the controller to the valve terminal takes place via a pre-assembled or self-assembled multi-wire cable to the multi-pin plug connection, which substantially reduces installation time.

The valve terminal can be equipped with max. 24 solenoid coils. This corresponds to 4 to 24 MPA1 or 2 to 24 MPA2 valves, or a combination of both.

Versions

- Sub-D connection
- Pre-assembled multi-pin cable
- Multi-pin cable for self-assembly

AS-interface connection

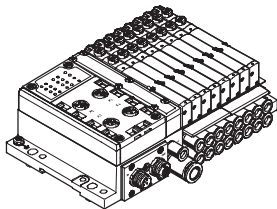

A special feature of the AS-interface is its ability to simultaneously transmit data and supply power via a two-wire cable. The encoded cable profile prevents connection with incorrect polarity. The valve terminal with AS-interface is available in the following versions:

- With two to eight modular valve positions (max. 8 solenoid coils). This corresponds to 2 to 8 MPA1 or 2 to 8 MPA2 valves, or a combination of both.
- With all available valve functions.

The connection technology used for the inputs can be selected as with CPX: M8, M12, Harax, Sub-D, Cage Clamp® (terminals to IP20).

Further information

➔ Internet: as-interface

CPI installation system

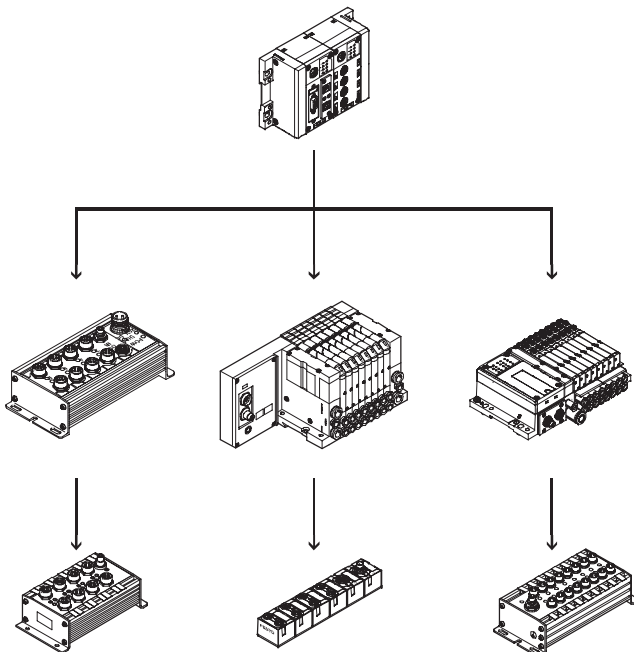

Valve terminal for CPI installation system:

Valve terminals with CP connection are intended for connection to higher-order fieldbus nodes or to control blocks. A fieldbus node or control block also enables the connection of decentralised input/output units. The following fieldbus protocols are supported:

- Festo fieldbus, ABB CS31, Moeller Suconet K
- Interbus
- Allen Bradley (1771 RIO)
- DeviceNet
- Profibus DP
- Profinet IO
- CC-Link
- Modbus/TCP
- Ethernet
- EtherCAT

Four strings with up to 32 inputs and outputs can be connected to a fieldbus node or control block. The connecting cables transmit the power supply for the input modules and the load voltage for the valves as well as control signals.

Further information

➔ Internet: ctec

Valve terminals type 32 MPA

Key features

FESTO

Fieldbus connection via the CPX system

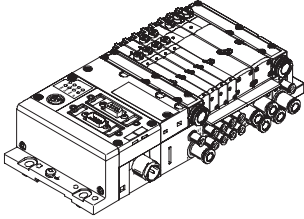

An integrated fieldbus node manages communication with a higher-order PLC. This enables a space-saving pneumatic and electronic solution.

Valve terminals with fieldbus interfaces can be configured with up to 16 manifold blocks. In conjunction with MPA1 and 8 solenoid coils per manifold block, up to 128 solenoid coils can thus be actuated. An MPA2 with 4 solenoid coils per manifold block can actuate 64 solenoid coils.

Versions

- Profibus DP
- ProfiNet
- Interbus
- DeviceNet connection
- CANopen
- CC-Link
- Ethernet/IP
- Front End Controller Remote
- Front End Controller Remote I/O
- Modbus/TCP
- Profinet IO
- EtherCAT
- CPX terminal
 - ➔ Internet: cpx

Control block connection via the CPX system

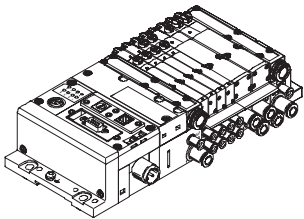

Controllers integrated in the Festo valve terminals enable the construction of stand-alone control units to IP65, without control cabinets.

Using the slave operation mode, these valve terminals can be used for intelligent pre-processing and are therefore ideal modules for designing decentralised intelligence.

In the master operation mode, terminal groups can be designed with many options and functions which can autonomously control a medium-sized machine/system.

- CPX terminal
 - ➔ Internet: cpx

Valve terminals type 32 MPA

Peripherals overview



Modular pneumatic components

The modular design of the MPA facilitates maximum flexibility right from the planning stage and offers maximum ease of service in operation.

The system consists of manifold blocks and valves. The manifold blocks are screwed together and thus form the support system for the valves.

They contain the connection ducts for supplying compressed air to and venting from the valve terminal as well as the working lines for the pneumatic drives for each valve.

Each manifold block is connected to the next using three screws. Individual terminal sections can be isolated and further manifold blocks inserted by loosening these screws. This ensures that the valve terminal can be rapidly and reliably extended.

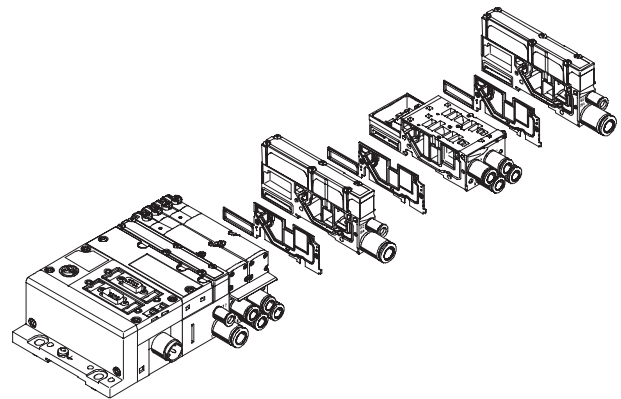
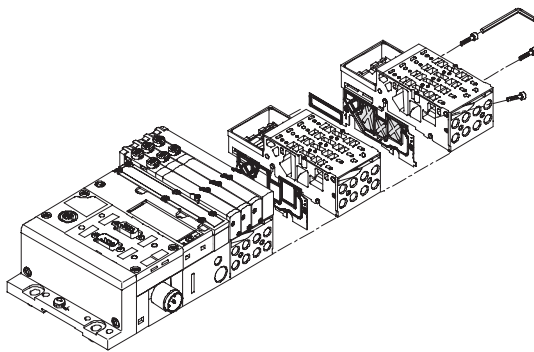

Modular electrical peripherals

The manner in which the valves are actuated differs according to whether you are using a multi-pin terminal, fieldbus terminal or individual valve. The MPA with CPX interface is based on the internal bus system of the CPX and uses this serial communication system for all solenoid coils and a range of electrical input and output functions.

Serial linking facilitates the following:

- Transmission of switching information
- High valve density
- Compact design
- Position-based diagnostics

- Separate voltage supply for valves
- Flexible conversion without address shifting
- Transmission of status, parameter and diagnostic data
- ➔ Internet: cpx

- Option of CP interface
- CPX-FEC as stand-alone controller with access via Ethernet and web server

MPA with electrical peripherals CPX

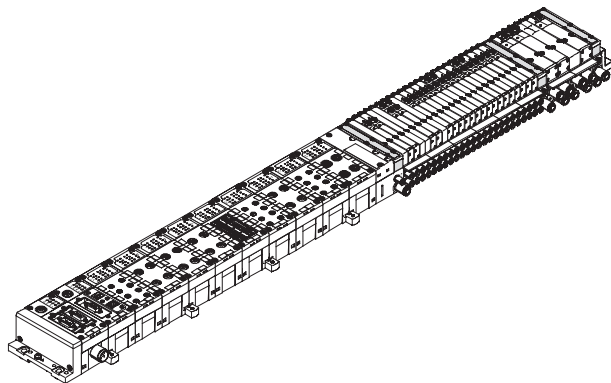

Modularity with electrical peripherals CPX

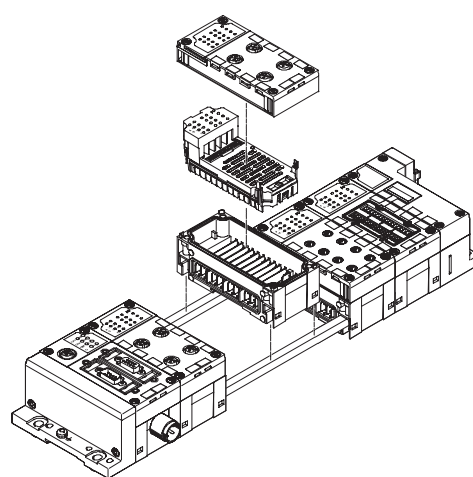

Valve terminals type 32 MPA

Peripherals overview

Individual sub-base size 1

Ordering:

- Using individual part numbers

Individual sub-bases can be equipped with any valve.

The electrical connection is established using a standard 4-pin M8 plug (EN 60947-5-2).

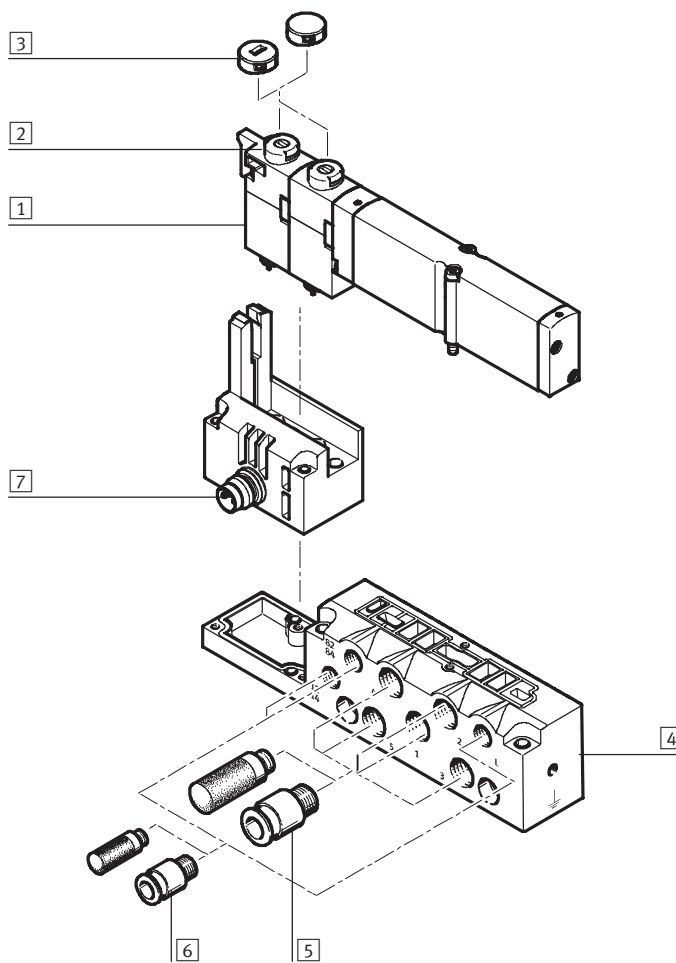

Designation	Brief description	→ Page/Internet
1 Solenoid valve	MPA1	69
2 Manual override	Non-detenting/turning with detent, per solenoid coil	-
3 Cover cap for manual override	Conversion from detenting/non-detenting to non-detenting or covered	74
4 Sub-base	For individual valve MPA1	71
5 Fittings and/or silencers	M7 for working lines (2, 4) and work air supply/exhaust ports (1, 3, 5)	76
6 Fittings, silencers or blanking plugs	M5 for pilot air supply/pilot exhaust air (12/14, 82/84) and pressure compensation	76
7 Electrical connection M8	4-pin	-

Valve terminals type 32 MPA

Peripherals overview

Individual sub-base size 2

Ordering:

- Using individual part numbers

Individual sub-bases can be equipped with any valve.

The electrical connection is established using a standard 4-pin M8 plug (EN 60947-5-2).

An adjustable pressure regulator can be installed between the manifold block and the valve in order to control the force of the triggered actuator.

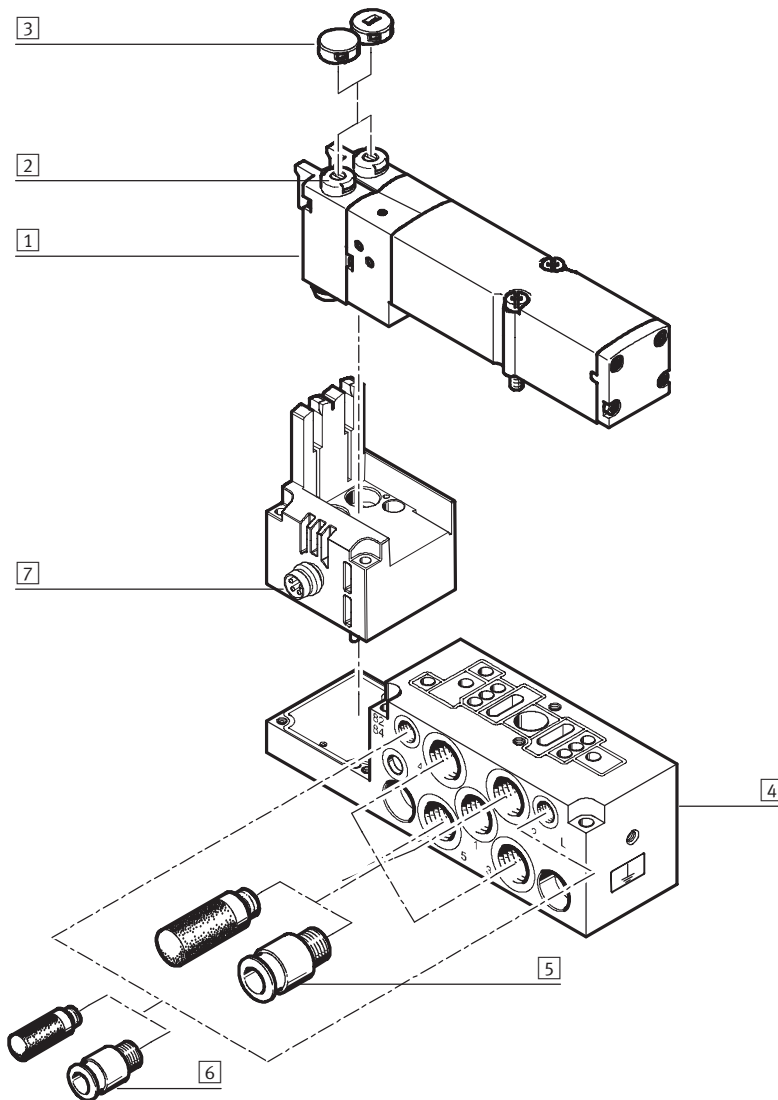

Designation	Brief description	→ Page/Internet
1 Solenoid valve	MPA2	69
2 Manual override	Non-detenting/turning with detent, per solenoid coil	-
3 Cover cap for manual override	Conversion from detenting/non-detenting to non-detenting or covered	74
4 Sub-base	For individual valve MPA2	71
5 Fittings and/or silencers G $\frac{1}{8}$	For working lines (2, 4) and work air supply/exhaust ports (1, 3, 5)	76
6 Fittings, silencers or blanking plugs M5	For pilot air supply/pilot exhaust air (12/14, 82/84) and pressure compensation	76
7 Electrical connection M8	4-pin	-

Valve terminals type 32 MPA

Peripherals overview



Pneumatic components of the valve terminal – Multi-pin plug, AS-interface

The manifold blocks are either prepared for:

- 2 or 4 single solenoid valves
- 2 or 4 double solenoid valves depending on the size.
- Double solenoid valve positions can be equipped with any valve or a blanking plate.
- Single solenoid valve positions can only be equipped with single solenoid valves.

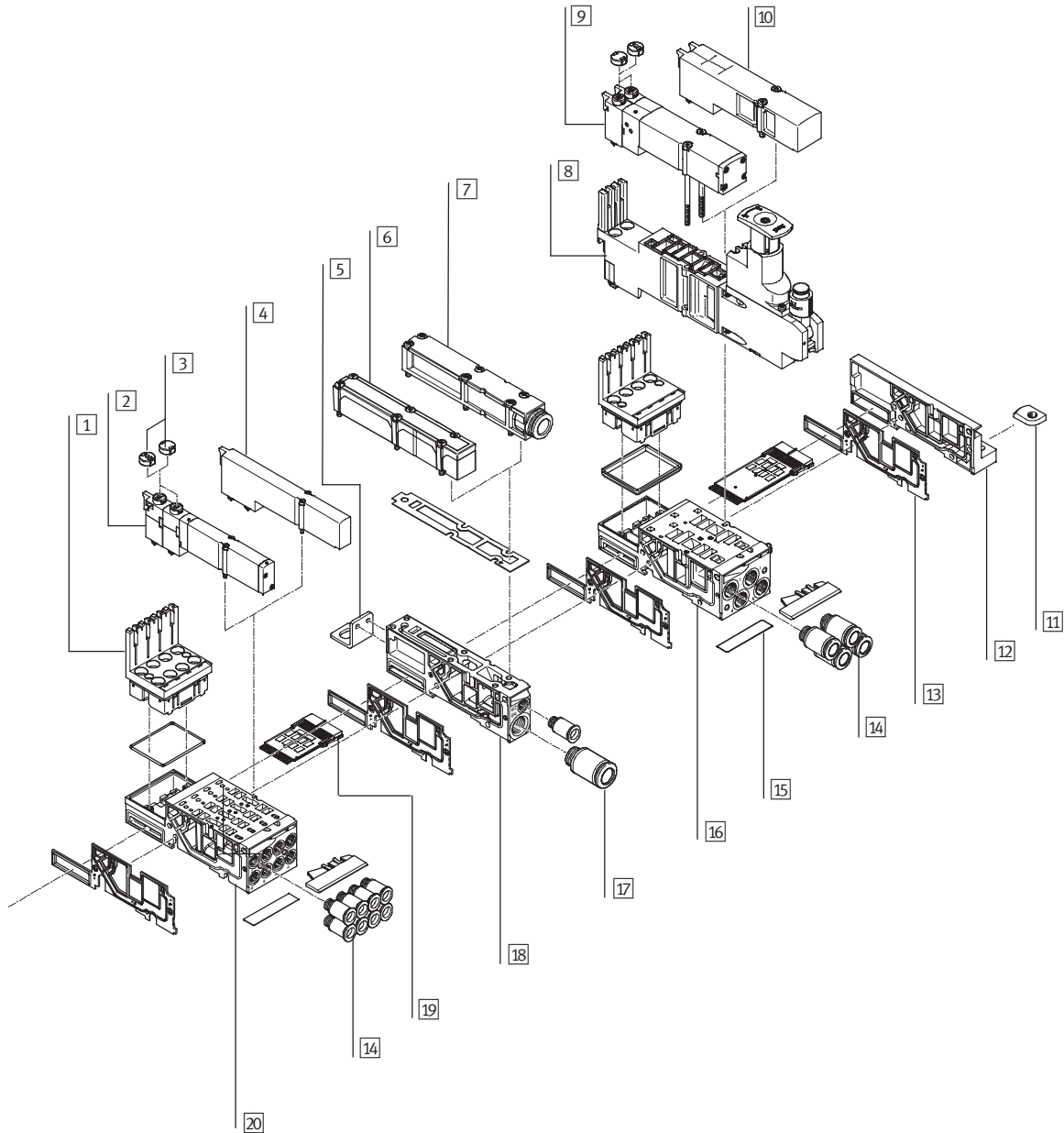

Valve terminals type 32 MPA

Peripherals overview

FESTO

Pneumatic components of the valve terminal – Multi-pin plug, AS-interface		
Designation	Brief description	→ Page/Internet
1	Electronics module	–
2	Solenoid valve	Size 1
3	Cover cap for manual override	Conversion from detenting/non-detenting to non-detenting or covered
4	Blanking plate	For unused valve position (vacant position), size 1
5	Mounting	Optional for valve terminal mounting (on supply plate)
6	Flat plate silencer	–
7	Exhaust plate	For ducted exhaust air
8	Regulator plate	Size 2
9	Solenoid valve	Size 2
10	Blanking plate	For unused valve position (vacant position), size 2
11	H-rail mounting	–
12	Right-hand end plate	–
13	Separating seal	For manifold block
14	Fittings	For working lines
15	Inscription label	–
16	Manifold block	Size 2
17	Fittings	For pneumatic supply plate
18	Supply plate	–
19	Electrical manifold module	For multi-pin plug connection, for AS-interface
20	Manifold block	Size 1

Valve terminals type 32 MPA

Peripherals overview

Pneumatic components of the valve terminal – CPI connection, fieldbus

The manifold blocks are either prepared for:

- 2 or 4 single solenoid valves
- 2 or 4 double solenoid valves depending on the size.

- Double solenoid valve positions can be equipped with any valve or a blanking plate.

- Single solenoid valve positions can only be equipped with single solenoid valves.

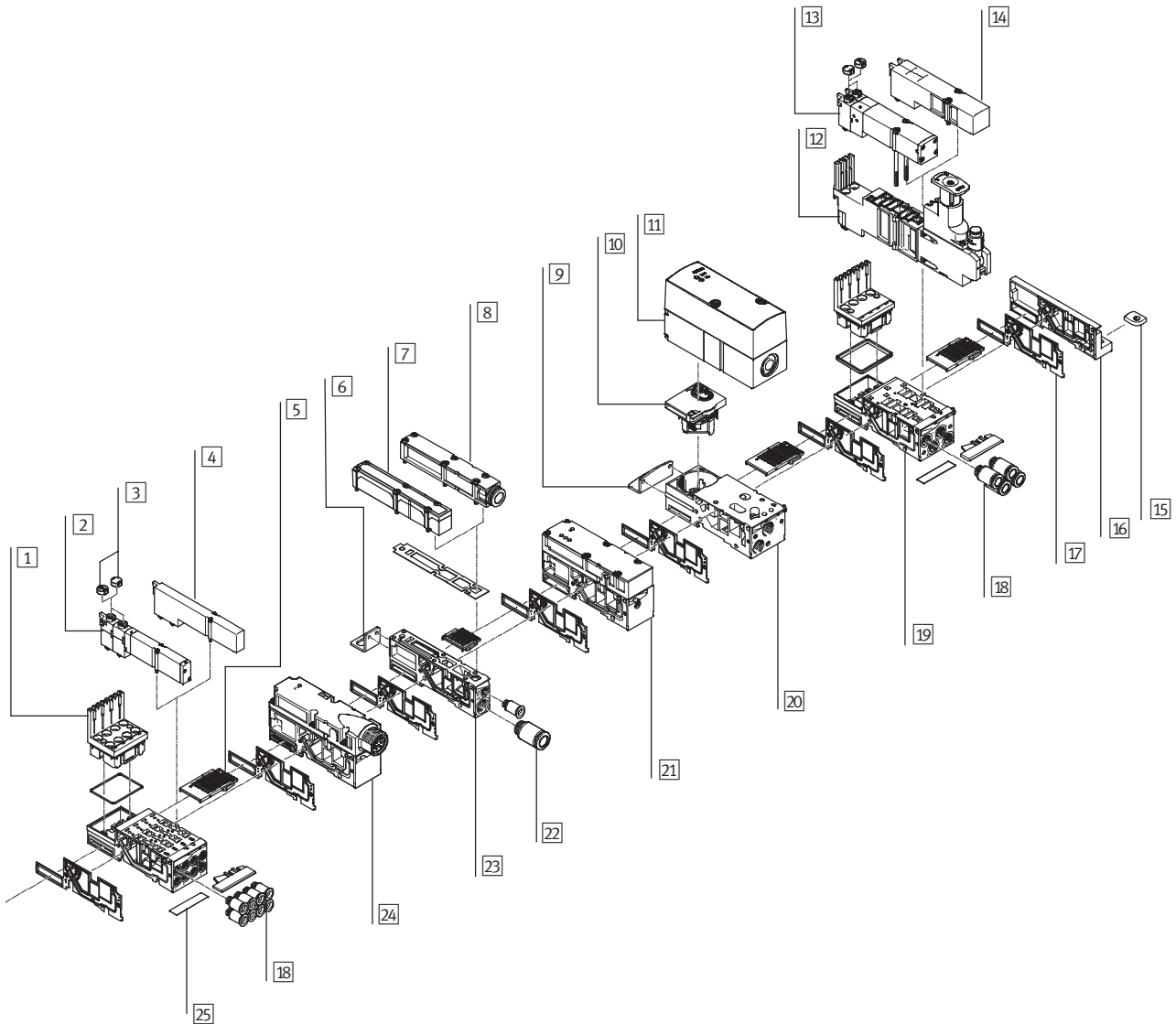

Valve terminals type 32 MPA

Peripherals overview

FESTO

Pneumatic components of the valve terminal – CPI connection, fieldbus		
Designation	Brief description	→ Page/Internet
1	Electronics module	73
2	Solenoid valve	69
3	Cover cap for manual override	–
4	Blanking plate	For unused valve position (vacant position), size 1
5	Electrical manifold module	For fieldbus connection, for proportional pressure regulator
6	Mounting	Optional for valve terminal mounting (on supply plate)
7	Flat plate silencer	–
8	Exhaust plate	For ducted exhaust air
9	Mounting	Optional for valve terminal mounting (on the manifold block of the proportional pressure regulator)
10	Electrical module	For proportional pressure regulator
11	Proportional pressure regulator	–
12	Regulator plate	Size 2
13	Solenoid valve	Size 2
14	Blanking plate	For unused valve position (vacant position), size 2
15	H-rail mounting	–
16	Right-hand end plate	–
17	Separating seal	For manifold block
18	Fittings	For working lines
19	Manifold block	Size 2
20	Manifold block	For proportional pressure regulator
21	Pressure sensor	–
22	Fittings	For pneumatic supply plate
23	Supply plate	–
24	Electrical supply plate	For auxiliary voltage supply for large valve terminals
25	Inscription label	–

Valve terminals type 32 MPA

Peripherals overview

Valve terminal with multi-pin plug connection

Order code:

- 32P-... for the pneumatic components
- 32E-... for the electrical components

MPA valve terminals with multi-pin plug connection can be expanded by up to 24 solenoid coils.

The multi-pin plug connection is designed as a removable 25-pin Sub-D connection to IP65.

The cable can be selected when ordering:

- 2.5 m
- 5 m
- 10 m

Each can be used for max. 8 or 24 valves.

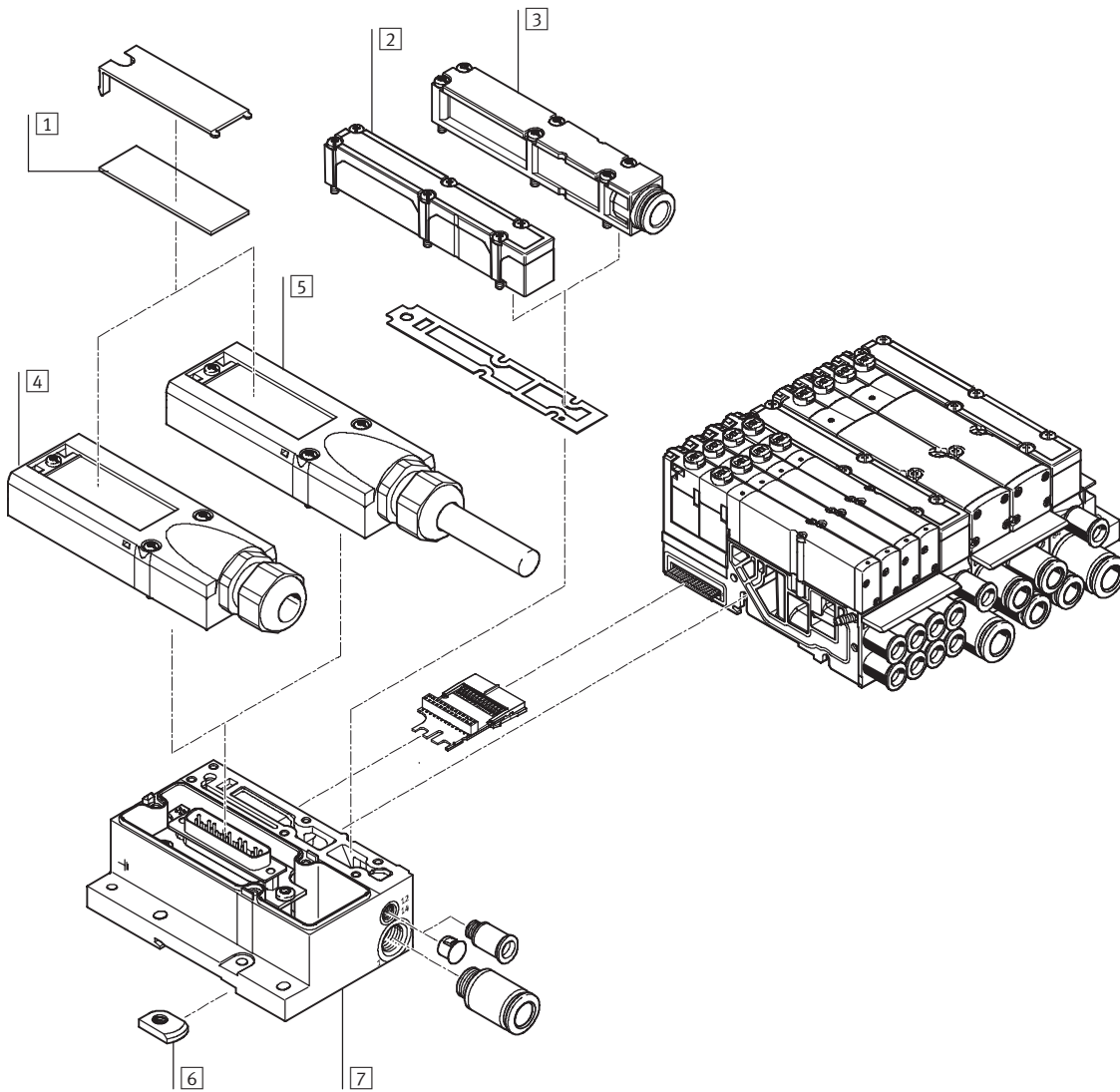

Designation	Brief description	→ Page/Internet
1 Inscription labels	Large, for multi-pin plug connection	-
2 Flat plate silencer	For pneumatic interface	-
3 Exhaust plate	For ducted exhaust air	74
4 Multi-pin plug connection	For self-assembly	75
5 Multi-pin plug connection	With multi-pin cable	75
6 H-rail mounting	-	71
7 Electrical interface	For multi-pin plug	72

Valve terminals type 32 MPA

Peripherals overview

Valve terminal with AS-interface connection

Order code:

- 32P-... for the pneumatic components
- 52E-... for the electrical components

MPA valve terminals with AS-interface connection can be expanded by up to 8 solenoid coils.

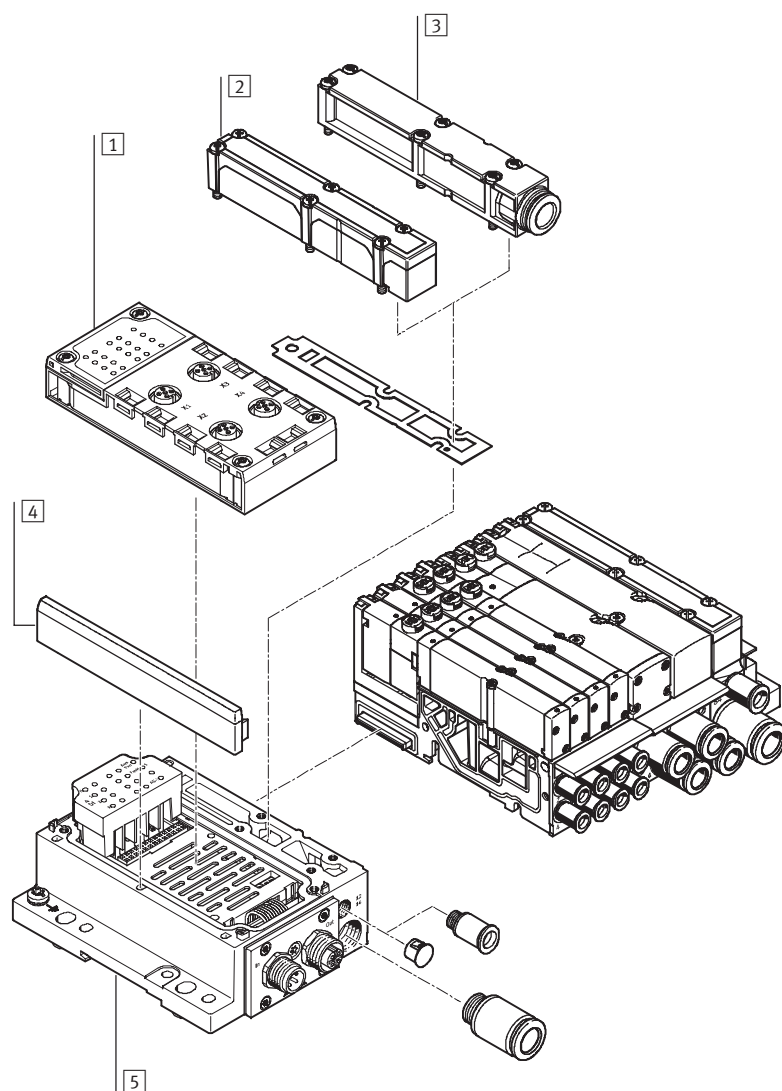

Designation	Brief description	→ Page/Internet
1 Manifold block	-	72
2 Flat plate silencer	For pneumatic interface	-
3 Exhaust plate	For ducted exhaust air	74
4 Cover	-	-
5 Electrical interface	-	72

Valve terminals type 32 MPA

Peripherals overview

Valve terminal with CPI connection

Order code:

- 32P-... for the pneumatic components
- 56E-... for the electrical components

MPA valve terminals with CPI connection can be expanded by up to 32 solenoid coils.

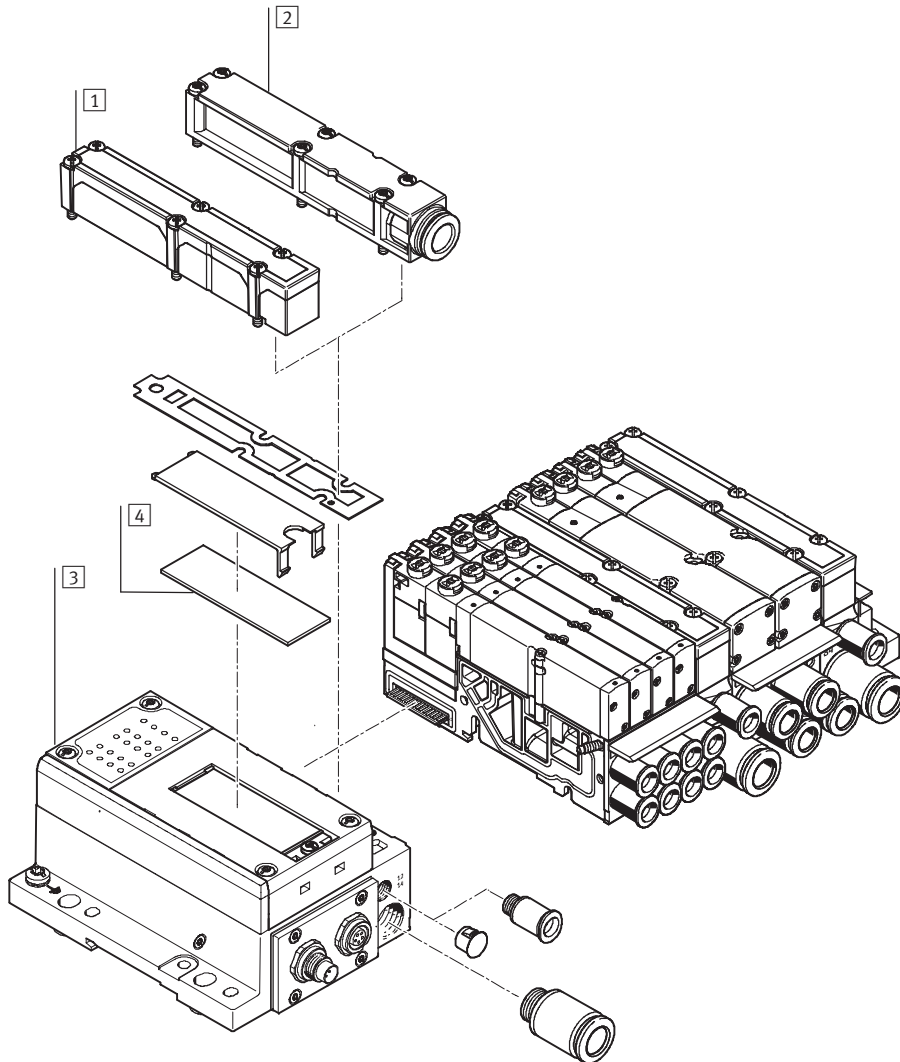

Designation	Brief description	→ Page/Internet
1 Flat plate silencer	For pneumatic interface	-
2 Exhaust plate	For ducted exhaust air	74
3 Electrical interface	-	72
4 Inscription label	Large for CPI electrical interface	-

Valve terminals type 32 MPA

Peripherals overview

Valve terminal with fieldbus connection, control block (electrical peripherals CPX)

Order code:

- 32P-... for the pneumatic components
- 50E-... for the electrical components

Valve terminals with fieldbus interfaces can be configured with up to 16 manifold blocks. In conjunction with MPA1 and 8 solenoid coils per manifold block, up to 128 solenoid coils can thus be equipped. An MPA2 with 4 solenoid coils per manifold block can actuate 64 solenoid coils.

Each valve position can be equipped with any valve or a blanking plate. The rules for CPX apply to the equipment that can be used in combination with the electrical peripherals CPX.
In general:

- Digital inputs/outputs
- Analogue inputs/outputs
- Parameterisation of inputs and outputs
- Integrated multi-featured diagnostic system
- Preventive maintenance concepts

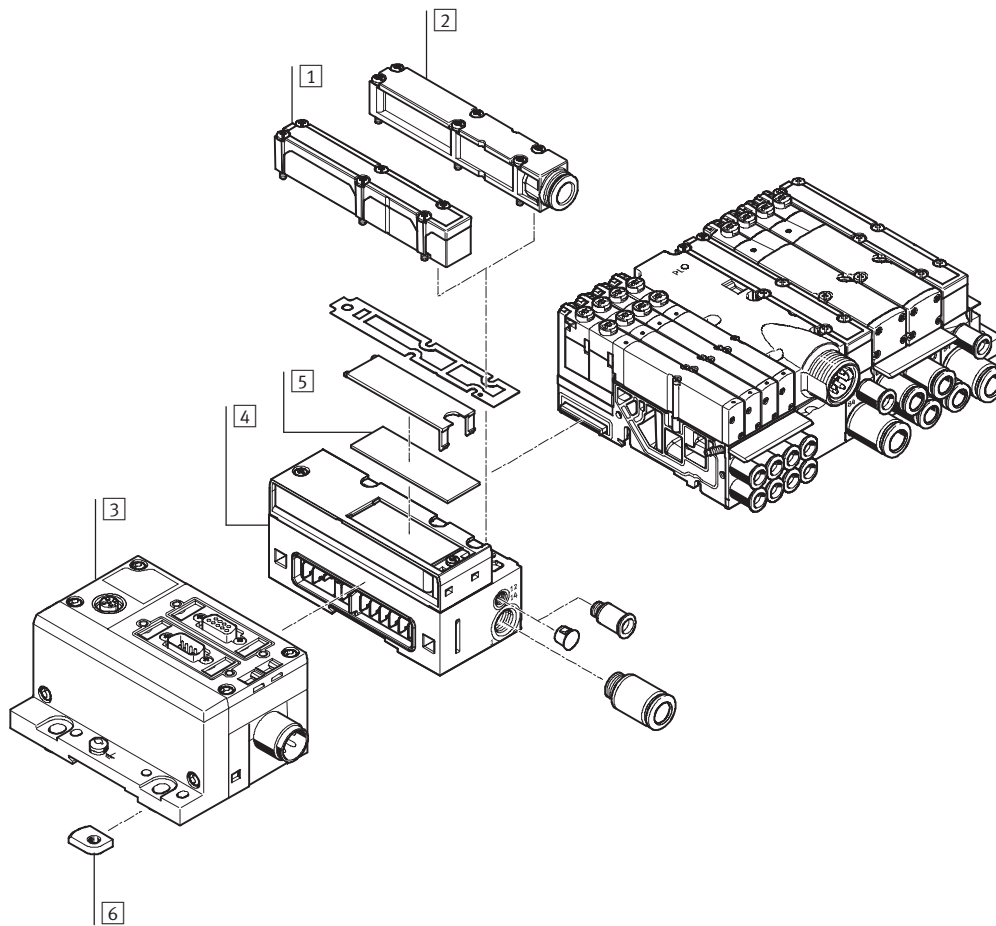

Designation	Brief description	→ Page/Internet
1 Flat plate silencer	For pneumatic interface	–
2 Exhaust plate	For ducted exhaust air	74
3 CPX modules	–	–
4 Pneumatic interface	For CPX modules	72
5 Inscription label	Large, for pneumatic interface CPX	–
6 H-rail mounting	–	71

Valve terminals type 32 MPA

Key features – Pneumatic components



Sub-base valve

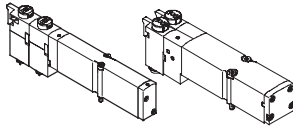

MPA offers a comprehensive range of valve functions. All valves are equipped with piston spool and patented sealing system which facilitates efficient sealing, a broad pressure range and long service life. To increase power they have a pneumatic pilot control supplied by pilot air.

Sub-base valves can be quickly replaced since the tubing connectors remain on the manifold block. This design is also particularly flat.

Irrespective of the valve function there are sub-base valves with one solenoid coil (single solenoid) or with two solenoid coils (double solenoid or two single solenoid valves in one housing).

Constructional design

Valve replacement

The valves are attached to the metal manifold block using two screws, which means that they can be easily

replaced. The mechanical sturdiness of the manifold block guarantees excellent long-term sealing.

Extension

Blanking plates can be replaced by valves at a later date. The dimensions, mounting points and existing pneumatic installations remain unchanged during this process.

The valve code (M, J, N, NS, K, KS, H, HS, B, G, E, X, W, D, DS I) is located on the front of the valve beneath the manual override.

Valve function				
Code	Circuit symbol	Size		Description
		1	2	
M		■	■	5/2-way valve, single solenoid <ul style="list-style-type: none"> • Pneumatic spring return • Reversible • Suitable for vacuum
J		■	■	5/2-way valve, double solenoid <ul style="list-style-type: none"> • Reversible • Suitable for vacuum
N		■	■	2x 3/2-way valve, single solenoid <ul style="list-style-type: none"> • Normally open • Pneumatic spring return • Operating pressure > 3 bar
NS		■	–	2x 3/2-way valve, single solenoid <ul style="list-style-type: none"> • Normally open • Mechanical spring return • Operating pressure –0.9 ... +8 bar
K		■	■	2x 3/2-way valve, single solenoid <ul style="list-style-type: none"> • Normally closed • Pneumatic spring return • Operating pressure > 3 bar
KS		■	–	2x 3/2-way valve, single solenoid <ul style="list-style-type: none"> • Normally closed • Mechanical spring return • Operating pressure –0.9 ... +8 bar

Valve terminals type 32 MPA

Key features – Pneumatic components

Valve function				
Code	Circuit symbol	Size		Description
		1	2	
H		■	■	2x 3/2-way valve, single solenoid <ul style="list-style-type: none"> • Normally <ul style="list-style-type: none"> – 1x closed – 1x open • Pneumatic spring return • Operating pressure > 3 bar
HS		■	–	2x 3/2-way valve, single solenoid <ul style="list-style-type: none"> • Normally <ul style="list-style-type: none"> – 1x closed – 1x open • Mechanical spring return • Operating pressure –0.9 ... +8 bar
B		■	■	5/3-way valve <ul style="list-style-type: none"> • Mid-position pressurised¹⁾ • Mechanical spring return • Reversible • Suitable for vacuum
G		■	■	5/3-way valve <ul style="list-style-type: none"> • Mid-position closed¹⁾ • Mechanical spring return • Reversible • Suitable for vacuum
E		■	■	5/3-way valve <ul style="list-style-type: none"> • Mid-position exhausted¹⁾ • Mechanical spring return • Reversible • Suitable for vacuum
X		■	■	1x 3/2-way valve, single solenoid <ul style="list-style-type: none"> • Normally closed • External compressed air supply • Pneumatic spring return • Reversible Compressed air (–0.9 ... +10 bar) supplied at working port 4 can be switched with both internal and external pilot air supply.
W		■	■	1x 3/2-way valve, single solenoid <ul style="list-style-type: none"> • Normally open • External compressed air supply • Pneumatic spring return • Reversible Compressed air (–0.9 ... +10 bar) supplied at working port 2 can be switched with both internal and external pilot air supply.
D		■	■	2x 2/2-way valve <ul style="list-style-type: none"> • Normally closed • Pneumatic spring return • Operating pressure > 3 bar
DS		■	–	2x 2/2-way valve <ul style="list-style-type: none"> • Normally closed • Mechanical spring return • Operating pressure –0.9 ... +8 bar

Valve terminals type 32 MPA

Key features – Pneumatic components



Valve function				
Code	Circuit symbol	Size		Description
		1	2	
1		■	■	2x 2/2-way valve <ul style="list-style-type: none"> • 1x normally closed • 1x normally closed, reversible • Pneumatic spring return • Operating pressure > 3 bar • Vacuum at port 3/5 only

- 1) If neither solenoid coil is energised, the valve moves to its mid-position by means of spring force.
 If both coils are energised at the same time, the valve remains in the previously assumed switching position.

- - Note

A filter must be placed upstream of valves in vacuum mode. This prevents the ingress of foreign matter in the intake air into the valve (e.g. when operating a suction cup).

Valve terminals type 32 MPA

Key features – Pneumatic components

Vertical stacking

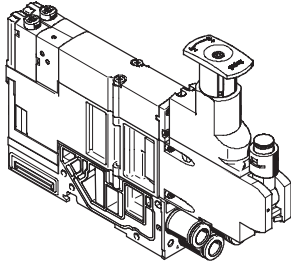

Additional function units can be added to each valve position between the sub-base and the valve.

These functions are known as vertical stacking, and enable special function-

ing or control of an individual valve position.

Vertical stacking components

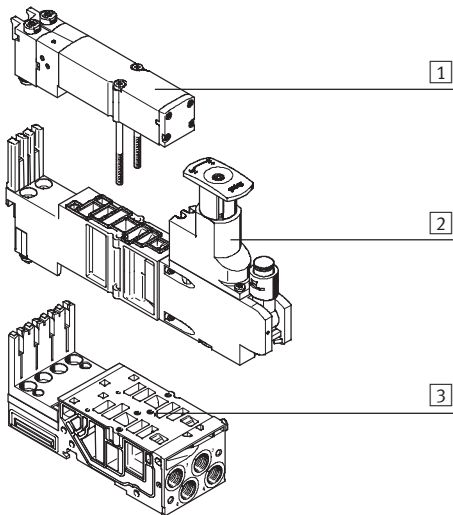

- 1 VMPA2 valve
- 2 Pressure regulator plate
- 3 Manifold block

Vertical stacking

Pressure regulator plate

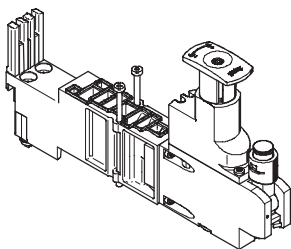

An adjustable pressure regulator can be installed between the manifold block and the valve in order to control the force of the triggered actuator.

This pressure regulator maintains an essentially constant output pressure (secondary side) independent of pressure fluctuations (primary side) and air consumption.

Standard version:

- For supply pressure up to 6 bar or up to 10 bar
- Without pressure gauge (optional)
- Regulator head with 3 positions (locked, reference position, free running)

Valve terminals type 32 MPA

Key features – Pneumatic components



Vertical stacking

Mode of operation of the pressure regulator plate (P regulator) for port 1; code: PA, PF

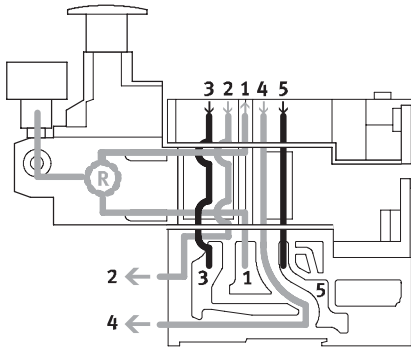

This pressure regulator regulates the pressure upstream of the valve in duct 1. Ducts 2 and 4 thus have the same regulated pressure.

During venting, the exhaust flow in the valve is from duct 2 to duct 3 and from duct 4 to duct 5.

Advantages

- The pressure regulator is not affected by venting, since the pressure is regulated upstream of the valve.
- The pressure regulator can always be adjusted, since the pressure from the valve terminal is always present.

Application examples

- An equal working pressure is required at working ports 2 and 4.
- A lower working pressure (e.g. 3 bar) than the operating pressure present at the valve terminal (e.g. 8 bar) is required.

Mode of operation of the pressure regulator plate (B regulator) for port 2; code: PC, PH

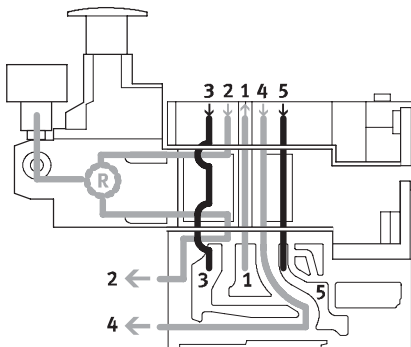

This pressure regulator regulates the pressure in duct 2 after the pressure medium flows through the valve. During venting, the exhaust flow in the valve is from duct 2 to duct 3 via the pressure regulator.

Restrictions

The pressure regulator can only be adjusted in switched state (e.g. the valve is switched to 2 and exhaust flow occurs from 4 to 5).

Application example

The pressure regulator makes it possible to reduce the pressure at port 2 of an individual valve, in contrast to the operating pressure of the valve terminal.

Valve terminals type 32 MPA

Key features – Pneumatic components

Vertical stacking

Mode of operation of the pressure regulator plate (A regulator) for port 4; code: PB, PK

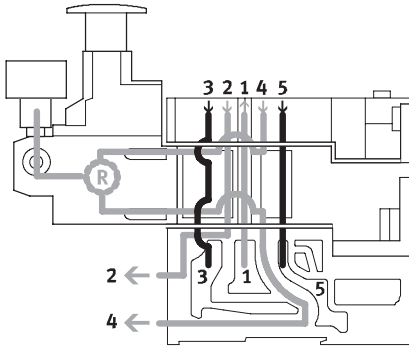

This pressure regulator regulates the pressure in duct 4 after the pressure medium flows through the valve. During venting, the exhaust flow in the valve is from duct 4 to duct 5 via the pressure regulator.

Restrictions

The pressure regulator can only be adjusted in switched state (e.g. the valve is switched to 4 and exhaust flow occurs from 2 to 3).

Application example

If different working pressures are required at ports 4 and 2. The pressure present at port 2 is from duct 1.

Mode of operation of the pressure regulator plate (B regulator, reversible) for port 2, reversible; code: PL, PN

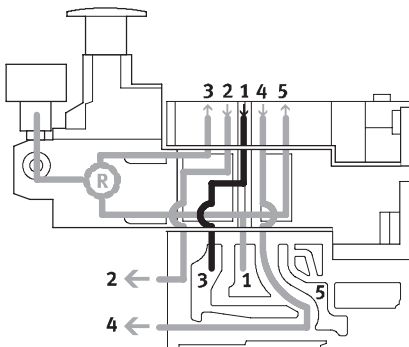

The reversible B regulator splits the supply air in duct 1 and regulates the pressure upstream of the valve in duct 3 (the unregulated pressure from duct 1 is in duct 5). The regulated air is then supplied to duct 2. The valve is thus operated in reversible mode.

During venting, the exhaust flow in the valve is from duct 2 to duct 1 and it is reversed into the manifold block via the intermediate plate to duct 3.

Application examples

- When instead of the operating pressure of the valve terminal, a different pressure is required in duct 2.
- When fast exhaust venting is required.
- When the pressure regulator must always be adjustable.

 Note

Reversible pressure regulator plates may only be combined with valves that can be operated in reversible mode.

Advantages

- Fast cycle times.
- 50% higher exhaust flow rate, as air is not exhausted via the pressure regulator. The load on the pressure regulator is also reduced.
- No quick exhaust valves are required.
- Operating pressure is always present at the pressure regulator, as the pressure is regulated upstream of the valve, i.e. the regulator can always be adjusted.

Restrictions

- 2x 3/2-way valves (code N, K, H) are not used, as pressure is present at ports 3 and 5.

Valve terminals type 32 MPA

Key features – Pneumatic components



Vertical stacking

Mode of operation of the pressure regulator plate (A regulator, reversible) for port 4, reversible; code: PK, PM

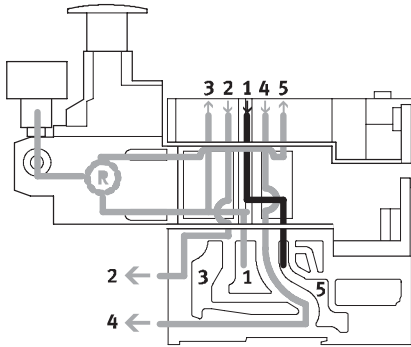

The reversible A regulator splits the working air in duct 1 and supplies the pressure upstream of the valve into duct 5 (the unregulated pressure from duct 1 is in duct 3). The regulated air is then supplied to duct 4. The valve is thus operated in reversible mode.

During venting, the exhaust flow in the valve is from duct 4 to duct 1 and it is reversed into the manifold block via the intermediate plate to duct 5.

Application examples

- When instead of the operating pressure of the valve terminal, a different pressure is required in duct 4.
- When fast exhaust venting is required.
- When the pressure regulator must always be adjustable.



Note

Reversible pressure regulator plates may only be combined with valves

that can be operated in reversible mode.

Advantages

- Fast cycle times.
- 50% higher exhaust flow rate, as air is not exhausted via the pressure regulator. The load on the pressure regulator is also reduced.
- No quick exhaust valves are required.
- Operating pressure is always present at the pressure regulator, as the pressure is regulated upstream of the valve, i.e. the regulator can always be adjusted.

Restrictions

- 2x 3/2-way valves (code N, K, H) are not used, as pressure is present at ports 3 and 5.

Valve terminals type 32 MPA

Key features – Pneumatic components



Vertical stacking – Pressure regulator plate							
Code		Type	Size		Supply pressure		Description
			1	2	6 bar	10 bar	
Pressure regulator plate for port 1 (P regulator)							
PA		VMPA2-B8-R1C2-C-10	-	■	-	■	<ul style="list-style-type: none"> Regulates the operating pressure in duct 1 upstream of the directional control valve
PF		VMPA2-B8-R1C2-C-06	-	■	■	-	
Pressure regulator plate for port 2 (B regulator)							
PC		VMPA2-B8-R2C2-C-10	-	■	-	■	<ul style="list-style-type: none"> Regulates the operating pressure in duct 2 downstream of the directional control valve
PH		VMPA2-B8-R2C2-C-06	-	■	■	-	
Pressure regulator plate for port 4 (A regulator)							
PB		VMPA2-B8-R3C2-C-10	-	■	-	■	<ul style="list-style-type: none"> Regulates the operating pressure in duct 4 downstream of the directional control valve
PG		VMPA2-B8-R3C2-C-06	-	■	■	-	
Pressure regulator plate for port 2, reversible (B regulator)							
PL		VMPA2-B8-R6C2-C-10	-	■	-	■	<ul style="list-style-type: none"> Reversible pressure regulator to port 2
PN		VMPA2-B8-R6C2-C-06	-	■	■	-	
Pressure regulator plate for port 4, reversible (A regulator)							
PK		VMPA2-B8-R7C2-C-10	-	■	-	■	<ul style="list-style-type: none"> Reversible pressure regulator to port 4
PM		VMPA2-B8-R7C2-C-06	-	■	■	-	

Valve terminals type 32 MPA

Key features – Pneumatic components

Proportional pressure regulator

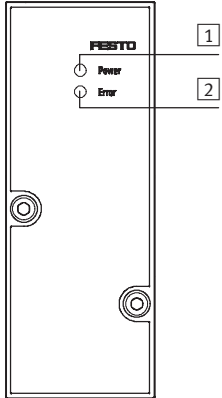

- 1 Green power LED
- 2 Red error LED

The purpose of the proportional pressure regulator VPPM-6TA-... is to regulate a pressure proportionally to a specified setpoint value. To this end, an integrated pressure sensor records the pressure at the working line and compares this value against the setpoint value. If there is a deviation between the nominal and actual values, the valve regulates the output

pressure until it reaches the setpoint value. The proportional pressure regulator has an additional supply connection to achieve the constant pressure supply required for high control quality. The proportional pressure regulator can be configured via the PLC or on-site via the handheld device (CPX-MMI) from Festo.

Proportional pressure regulator

Code	Graphical symbol	Type	Supply pressure 1	Pressure regulation range
2% full-scale linearity error				
QA		VPPM-6TA-L-1-F-0L2H	0 ... 4 bar	0.02 ... 2 bar
QB		VPPM-6TA-L-1-F-0L6H	0 ... 8 bar	0.06 ... 6 bar
QC		VPPM-6TA-L-1-F-0L10H	0 ... 11 bar	0.1 ... 10 bar
1% full-scale linearity error				
QD		VPPM-6TA-L-1-F-0L2H-S1	0 ... 4 bar	0.02 ... 2 bar
QE		VPPM-6TA-L-1-F-0L6H-S1	0 ... 8 bar	0.06 ... 6 bar
QF		VPPM-6TA-L-1-F-0L10H-S1	0 ... 11 bar	0.1 ... 10 bar

Valve terminals type 32 MPA

Key features – Pneumatic components

Layout of a control circuit

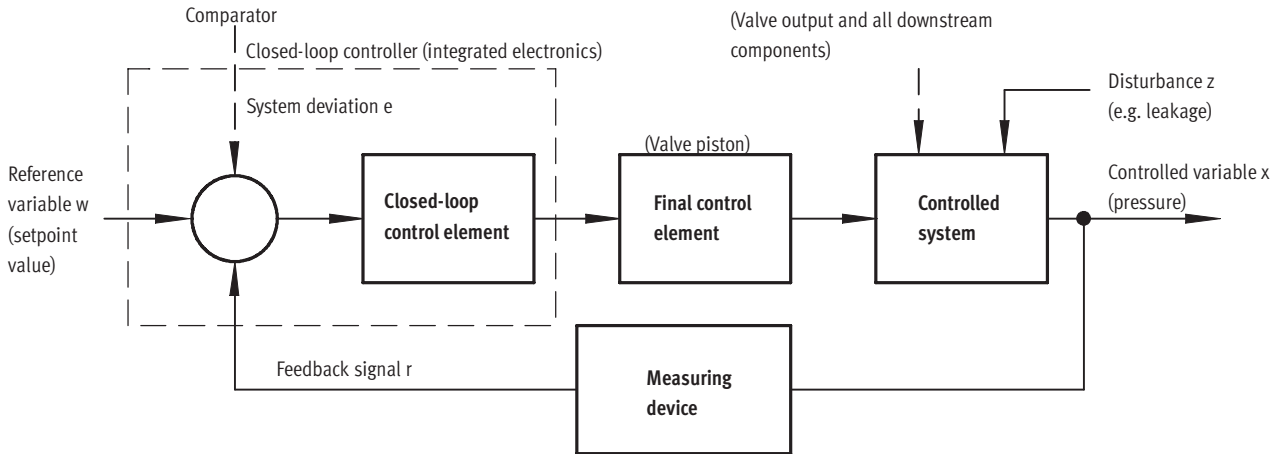

Layout

The figure shows a closed-loop control circuit. The reference variable w initially acts on a comparator. The measuring device sends the value of the controlled variable x (actual value, e.g. 3 bar) to the comparator as a feedback signal r . The closed-loop control element detects the system deviation e and actuates the final control

element. The output of the final control element acts on the controlled system. The closed-loop control element thus attempts to compensate for the difference between the reference variable w and the controlled variable x by using the final control

Method of operation

This process runs continuously so changes in the reference variable are always detected. However, a system deviation will also appear if the reference variable is constant but the controlled variable changes. This happens when the flow through the valve changes in response to a switching action, a cylinder movement or a change

in load. The disturbance variable z will also cause a system deviation. An example of this is when the pressure drops in the air supply. The disturbance variable z acts on the controlled variable x unintentionally. In all cases, the regulator attempts to readjust the controlled variable x to the reference variable w .

Multi-sensor control (cascade control) of the VPPM

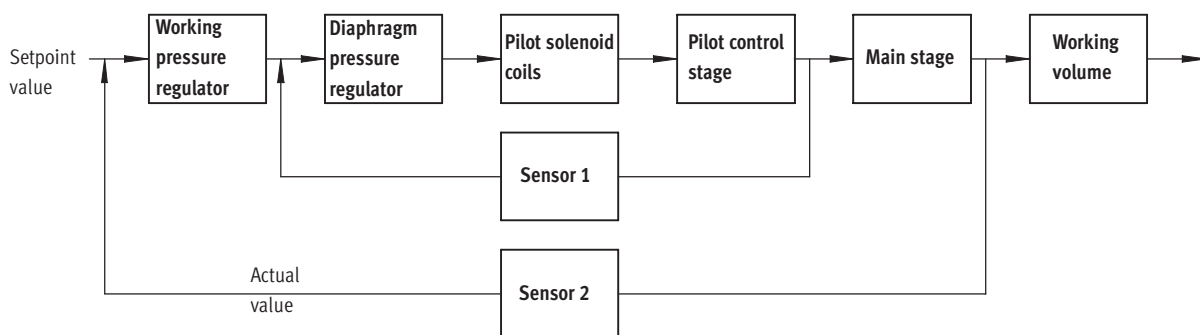

Cascade control

Unlike conventional direct-acting regulators, with multi-sensor control several control circuits are nested inside each other. The overall controlled

system is divided into smaller sub-controlled circuits that are easier to control for the specific task.

Control precision

Multi-sensor control significantly improves control precision and dynamic response in comparison with single-acting regulators.

Valve terminals type 32 MPA

Key features – Pneumatic components

Terms related to the proportional-pressure regulator

Hysteresis

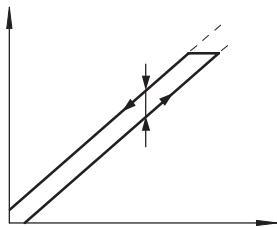

There is always a linear relationship within a certain tolerance between the setpoint value entered and the pressure output. Nevertheless it makes a difference whether the setpoint value is entered as rising or falling. The difference between the maximum deviations is referred to as hysteresis.

Linearity error

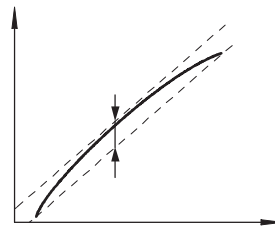

A perfectly linear progression of the control characteristic of the output pressure is theoretical. The maximum percentage deviation from this theoretical control characteristic is referred to as the linearity error. The percentage value refers to the maximum output pressure (full scale).

Response sensitivity

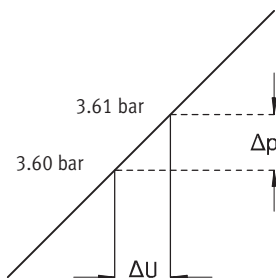

The response sensitivity of the device determines how sensitively one can change, i.e. adjust, a pressure. The smallest setpoint value difference that results in a change in the output pressure is referred to as the response sensitivity. In this case, 0.01 bar.

Repetition accuracy (reproducibility)

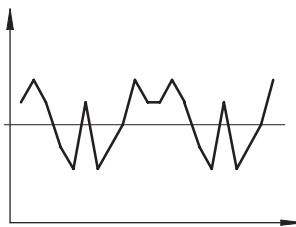

The repetition accuracy is the margin within which the fluid output variables are scattered when the same electrical input signal coming from the same direction is repeatedly adjusted. The repetition accuracy is expressed as a percentage of the maximum fluid output signal.

Zero point suppression

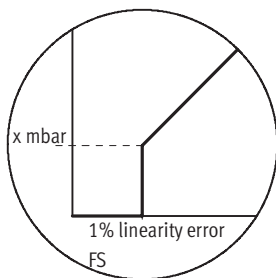

In practice there exists the possibility of residual voltage or residual current at the setpoint input of the VPPM via the setpoint generator. Zero point suppression is used so that the valve is reliably vented at a setpoint value of zero.

Valve terminals type 32 MPA

Key features – Pneumatic components



Blanking plate

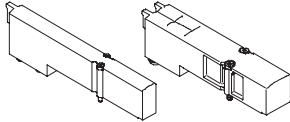

Plate without valve function for reserving valve positions on a valve terminal.

Valves and blanking plates are attached to the manifold block using two screws.

Valve function

Code	Circuit symbol	Size		Description
		1	2	
L	—	■	■	For valve terminal only: Blanking plate for vacant valve position

Compressed air supply and venting

Pneumatic interface

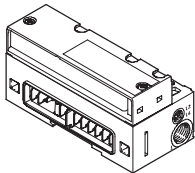

Supply plate

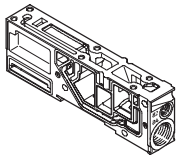

The valve terminal MPA can be supplied with air at one or more points. This ensures that the valve terminal will always have a sufficient supply of air and that this air will be vented, even with large-scale expansions.

The main supply to the valve terminal is located on the pneumatic interface, which links the electrical and the pneumatic parts. Additional provision is made for a number of supply plates. Venting is either via integrated flat plate silencers or common lines for ducted exhaust.

These vents are located on the pneumatic interface as well as on the supply plates. In the case of ducted exhaust, at least one additional supply plate is required that then contains the exhaust port for the pilot air supply (port 82/84).

Pilot air supply

The port for the main pneumatic supply is located on the pneumatic interface.

The ports differ for the following types of pilot air supply:

- Internal
- External

Internal pilot air supply

Internal pilot air supply can be selected if the required working pressure is between 3 and 8 bar. The pilot air supply is then branched from the compressed air supply 1 in the pneumatic interface using an internal connection. Port 12/14 is sealed with a blanking plug.

External pilot air supply

If the supply pressure is less than 3 bar or greater than 8 bar, you must operate your MPA valve terminal with external pilot air supply. In this case the pilot air is additionally supplied via port 12/14 on the pneumatic interface.



Note

If a gradual pressure build-up in the system using a soft-start valve is chosen, an external pilot air supply should be connected so that the control pressure applied during switch-on is already very high.

Valve terminals type 32 MPA

Key features – Pneumatic components



Compressed air supply and pilot air supply					
Code	Graphical symbol		Size		Notes
	Type of compressed air supply and pilot air supply		1	2	
	Pneumatic interface	Supply plate			
S			■	■	<p>Internal pilot air supply, flat plate silencer</p> <ul style="list-style-type: none"> Pilot air supply is branched internally from port 1 in the pneumatic interface Exhaust port 3/5 and pilot exhaust port 82/84 via flat plate silencer For operating pressure in the range 3 ... 8 bar
T			■	■	<p>External pilot air supply, flat plate silencer</p> <ul style="list-style-type: none"> Pilot air supply between 3 and 8 bar is connected to port 12/14 Exhaust port 3/5 and pilot exhaust port 82/84 via flat plate silencer For operating pressure in the range -0.9 ... 10 bar (suitable for vacuum)
V			■	■	<p>Internal pilot air supply, ducted exhaust air</p> <ul style="list-style-type: none"> Pilot air supply is branched internally from port 1 in the pneumatic interface Exhaust port 3/5: connection to pneumatic interface and supply plate Pilot exhaust port 82/84: connection to supply plate only For operating pressure in the range 3 ... 8 bar
X			■	■	<p>External pilot air supply, ducted exhaust air</p> <ul style="list-style-type: none"> Pilot air supply (3 ... 8 bar) is connected at port 12/14 Exhaust port 3/5: connection to pneumatic interface and supply plate Pilot exhaust port 82/84: connection to supply plate only For operating pressure in the range -0.9 ... 10 bar (suitable for vacuum)

Pneumatic interface					
Code	Pneumatic interface design variants		Size		Notes
	Graphical symbol		1	2	
	Type				
M		VMPA-...-EPL-...	■	■	<ul style="list-style-type: none"> Used together with compressed air supply S, T, V, X The pilot exhaust air must be vented at least at one supply plate when using V or X. In the case of multiple supply plates, the port 82/84 is open on the last supply plate ex-works.

Valve terminals type 32 MPA

Key features – Pneumatic components

Supply plate

Additional supply plates can be used for larger terminals or to create additional pressure zones.

If several valves are to be operated simultaneously at full flow rate, it is recommended that a supply plate be positioned after every 8 valves (MPA1), or 4 valves (MPA2).

Supply plates can be configured at any point upstream or downstream of sub-bases. This applies to the following interfaces:

- MPA with CPX
- MPA with multi-pin plug connection
- MPA with AS-interface connection
- MPA with CPI connection

MPA with ducted exhaust air

At least one supply plate via which the exhaust port 82/84 is vented is required with ducted exhaust air.

Supply plates contain the following ports:

- Compressed air supply (1)
- Venting of the pilot air supply (82/84) and pressure compensation
- Exhaust air (3/5)

Depending on your order, the exhaust ducts are either ducted or vented via the flat plate silencer.

The supply plate is configured using the code letter U if no directly adjoining separating seal is required.

If a separating seal (S, T or R) is selected to the direct right or left of the supply plate, then the code letter V or W identifies the position of the left-hand or right-hand separating seal. The code for the separating seal (S, T or R) is placed in front of the code for the supply plate (V or W).

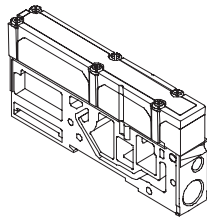
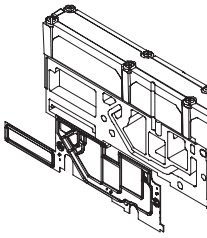
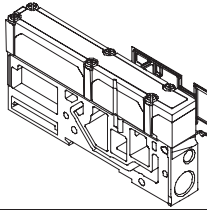
Supply plate					
Code ¹⁾	Graphical symbol	Type	Size		Notes
			1	2	
U		VMPA1-...-SP...	■	■	Supply plate without separating seal (no R, S or T selected)
V		VMPA1-...-SP...	■	■	Supply plate with separating seal on left, if R, S or T selected
W		VMPA1-...-SP...	■	■	Supply plate with separating seal on right, if R, S or T selected

1) The supply plate is equipped with silencer or exhaust plate depending on the code for the air supply S, T, V, X.

Valve terminals type 32 MPA

Key features – Electrical components



Electrical supply plate

Additional electrical supply plates can be used for larger terminals. This enables up to 64 valve positions/128 solenoid coils to be supplied.

MPA with CPX

Electrical supply plates can be configured at any point upstream or downstream of sub-bases. An electrical supply plate is required after 8 valve sub-bases.

MPA with CPI connection

Electrical supply plates can be configured at any point upstream or downstream of manifold blocks. An electrical supply plate is required after 8 valve sub-bases.



Note
Please note that only electrical modules with isolated electrical circuits are permissible to the right of the electrical supply plate.

The electrical supply plate must not be installed directly to the left of a pneumatic supply plate (type VMPA1-FB-SP...).



Note
Max. 24 of 32 MPA1 coils or 12 of 16 MPA2 coils can be switched on at the same time in the case of an MPA with CPI connection.

Electrical supply plate

Code	Graphical symbol	Type	Size		Notes
			1	2	
L		VMPA-FB-SP-V-SP	■	■	Electrical supply plate with M18 plug connection, 3-pin
		VMPA-FB-SP-7/8-V-5POL	■	■	Electrical supply plate with 7/8" plug connection, 5-pin
		VMPA-FB-SP-7/8-V-4POL	■	■	Electrical supply plate with 7/8" plug connection, 4-pin

Pin allocation for power supply

	Pin	Allocation
Pin allocation for M18		
	2	24 V DC valves
	3	0 V DC
	4	FE
Pin allocation for 7/8", 5-pin		
	1	0 V DC valves
	2	n.c.
	3	FE (leading)
	4	n.c.
	5	24 V DC valves
Pin allocation for 7/8", 4-pin		
	A	n.c.
	B	24 V DC valves
	C	FE
	D	0 V DC valves (leading)

Valve terminals type 32 MPA

Key features – Pneumatic components



Creation of pressure zones and separation of exhaust air

If different work pressures are required, MPA offers various possibilities for building up pressure zones. Depending on the electrical interface up to 16 pressure zones are possible. A pressure zone is created by isolating the internal supply ducts between the manifold blocks using an appropriate separating seal or using a separator that is permanently integrated in the manifold block (code I or code III).

Compressed air is supplied and vented via a supply plate. The position of the supply plates and separating seals can be freely selected with the valve terminal MPA.

Separating seals are integrated ex-works as per your order. Separating seals can be distinguished through their coding, even when the valve terminal is assembled.

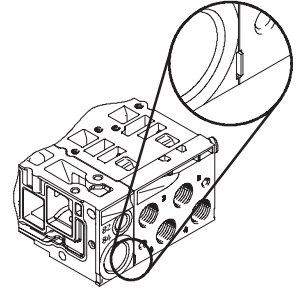

- Note

The following must be taken into consideration for subsequent expansion or conversions:

Different separating seals are required for operating with ducted exhaust air and operation with flat plate silencers.

Creating pressure zones							
Code	Separating seal for operating with flat plate silencer		Separating seal for operating with ducted exhaust air		Size		Notes
	Pictorial examples	Coding	Pictorial examples	Coding	1	2	
-					■	■	No duct separation
T					■	■	Duct 1 separate
S					■	■	Duct 1 and 3/5 separate
R					■	■	Duct 3/5 separate

Valve terminals type 32 MPA

Key features – Pneumatic components

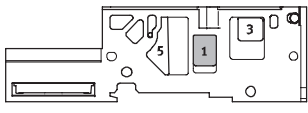
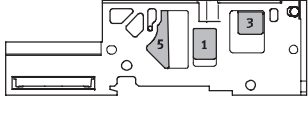

Creating pressure zones					
Code	Manifold block with duct separation for operating with flat plate silencer or with ducted exhaust air Pictorial examples	Coding	Size		Notes
			1	2	
I		-	■	■	Duct 1 separate
III		-	■	■	Duct 1 and 3/5 separate

-  - Note

The duct separation cannot be subsequently removed and is integrated in the centre of the manifold block:

- With size 1 between valves 2 and 3
- With size 2 between valves 1 and 2

Valve terminals type 32 MPA

Key features – Pneumatic components

Examples: Compressed air supply and pilot air supply

Internal pilot air supply, flat plate silencer

Pneumatic air supply to the valve terminal: code S

The diagram opposite shows an example of the configuration and connection of the air supply with internal pilot air supply. Port 12/14 on the pneumatic interface or the electrical interface (multi-pin plug) as appropriate is tightly sealed. Ports 3/5 and 82/84 are vented via the flat plate silencers. Port 82/84 is tightly sealed. Separating seals can be used optionally to create pressure zones.

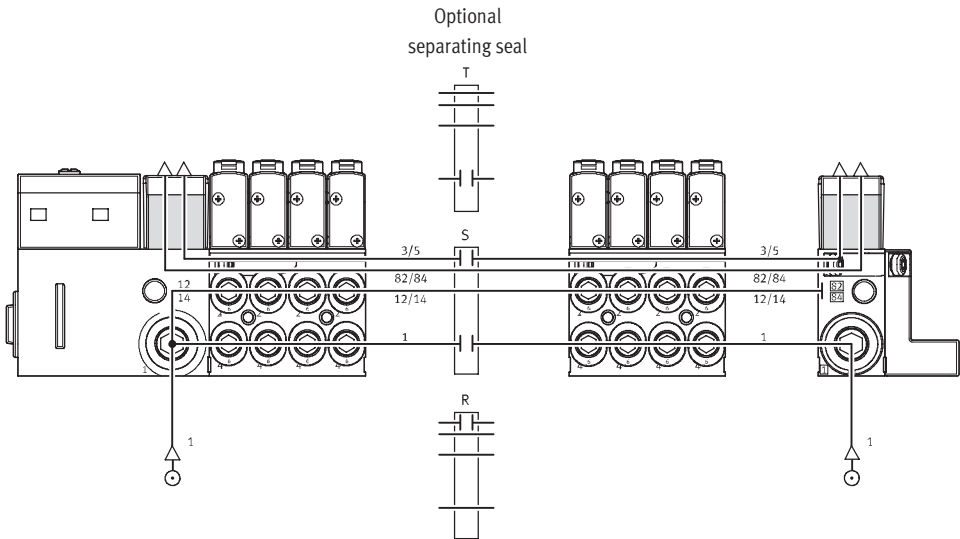

External pilot air supply, flat plate silencer

Pneumatic air supply to the valve terminal: code T

The diagram opposite shows an example of the configuration and connection of the compressed air supply with external pilot air supply. Port 12/14 on the pneumatic interface or the electrical interface (multi-pin plug) as appropriate is equipped with a threaded connector for this purpose. Ports 3/5 and 82/84 are vented via the flat plate silencers. Port 82/84 is tightly sealed. Separating seals can be used optionally to create pressure zones.

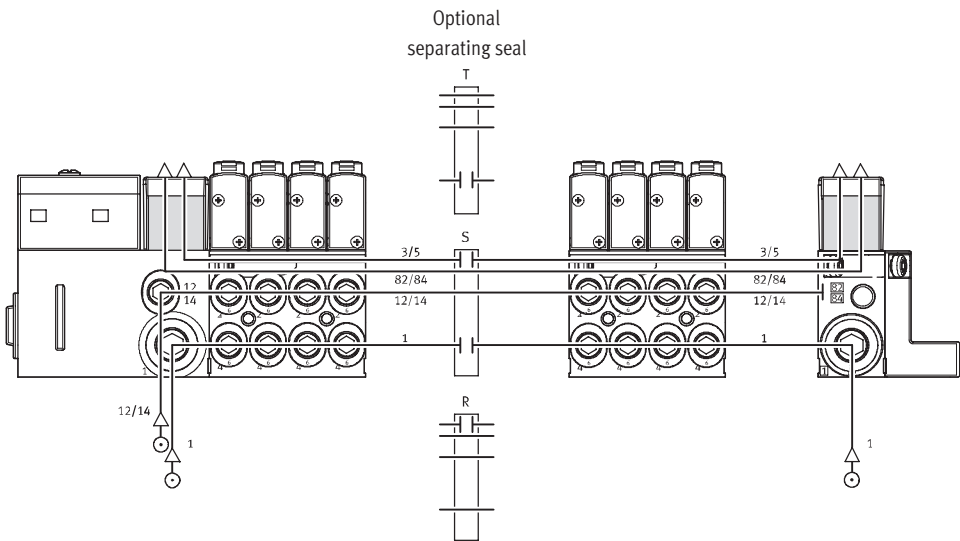

Valve terminals type 32 MPA

Key features – Pneumatic components



Examples: Compressed air supply and pilot air supply

Internal pilot air supply, ducted exhaust air

Pneumatic air supply to the valve terminal: code V
 The diagram opposite shows an example of the configuration and connection of the compressed air supply with internal pilot air supply. Port 12/14 on the pneumatic interface or the electrical interface (multi-pin plug) as appropriate is tightly sealed. Exhaust ports 3/5 and 82/84 are vented via the appropriate connections. Separating seals can be used optionally to create pressure zones.

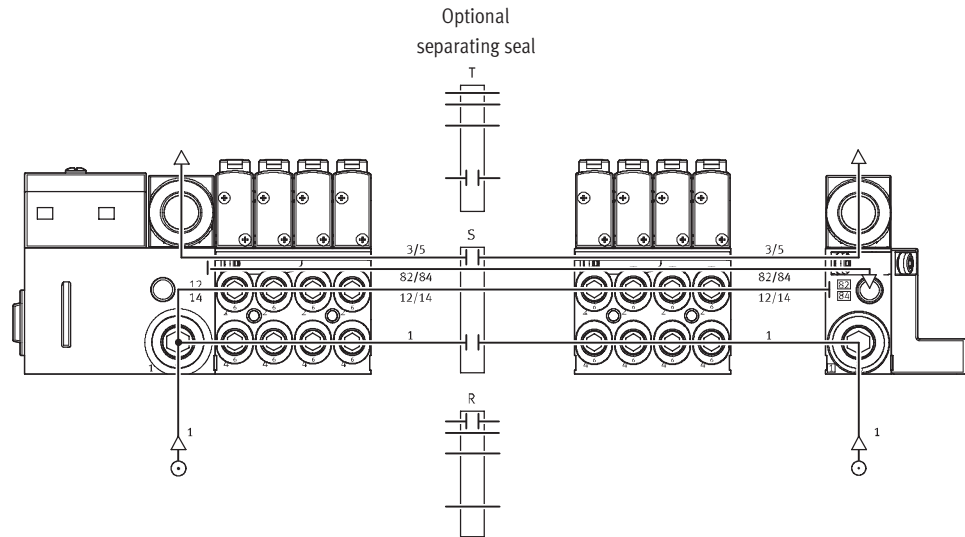

External pilot air supply, ducted exhaust air

Pneumatic supply to the valve terminal: code X
 The diagram opposite shows an example of the configuration and connection of the compressed air supply with external pilot air supply. Port 12/14 on the pneumatic interface or the electrical interface (multi-pin plug) as appropriate is equipped with a threaded connector for this purpose. Exhaust ports 3/5 and 82/84 are vented via the appropriate connections. Separating seals can be used optionally to create pressure zones.

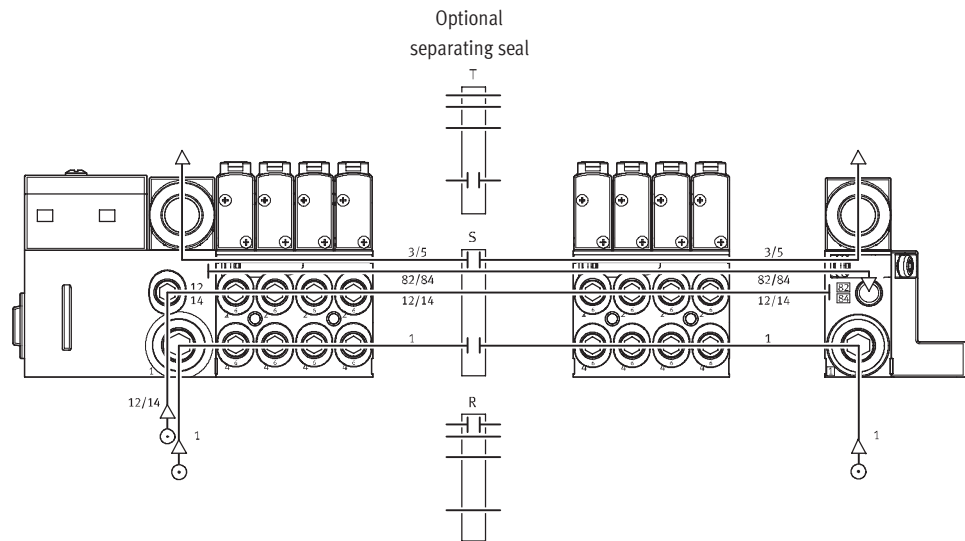

Valve terminals type 32 MPA

Key features – Pneumatic components

Examples: Creating pressure zones

MPA with CPX terminal connection

The diagram shows an example of the configuration and connection of three pressure zones using separating seals – with external pilot air supply.

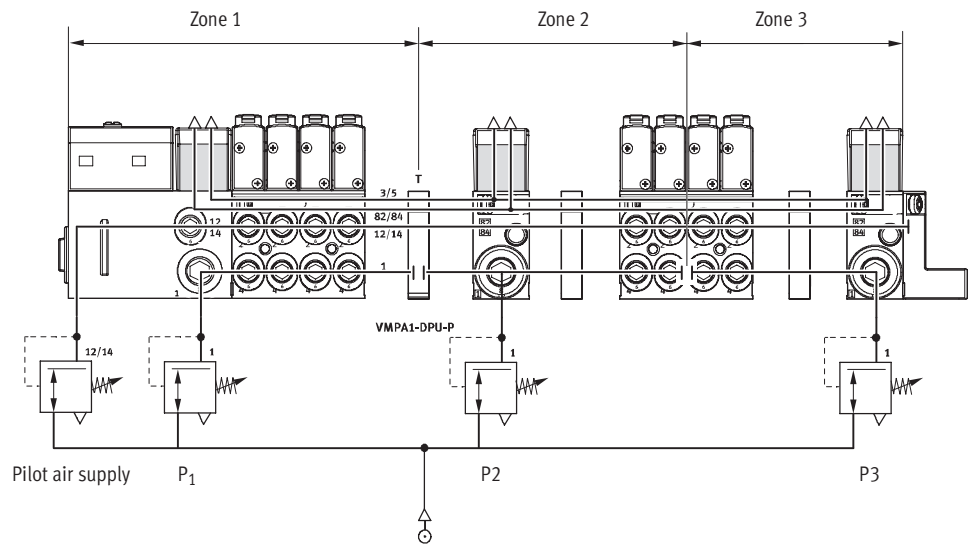

MPA with multi-pin plug connection

The diagram shows an example of the configuration and connection of the pressure zones – with external pilot air supply.

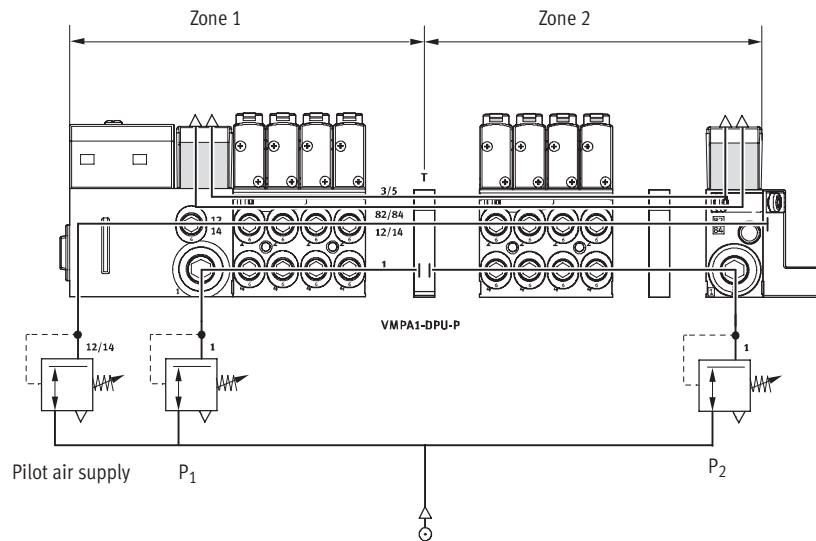

Valve terminals type 32 MPA

Key features – Pneumatic components



Examples: Creating pressure zones

Manifold block with pressure zone separation in duct 1

Another way of creating pressure zones is to use manifold blocks with pressure zone separation. The diagram opposite shows the version with pressure zone separation in duct 1.

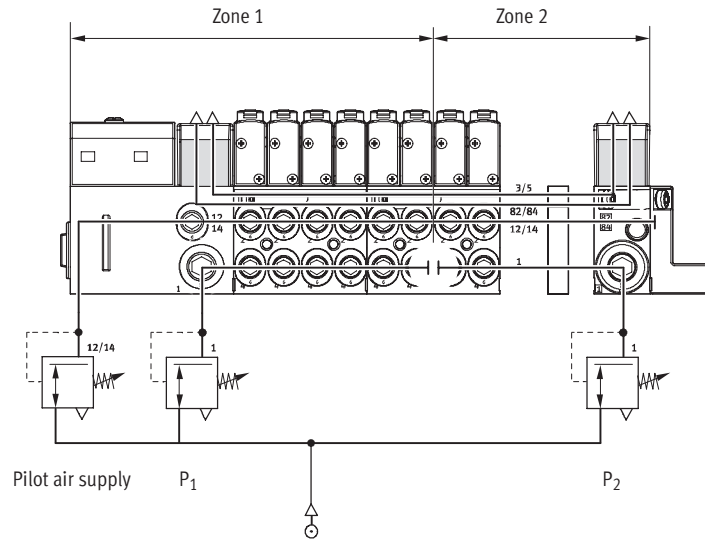

Manifold block with pressure zone separation in duct 1 and duct 3/5

The diagram opposite shows the version with pressure zone separation in duct 1 and duct 3/5.

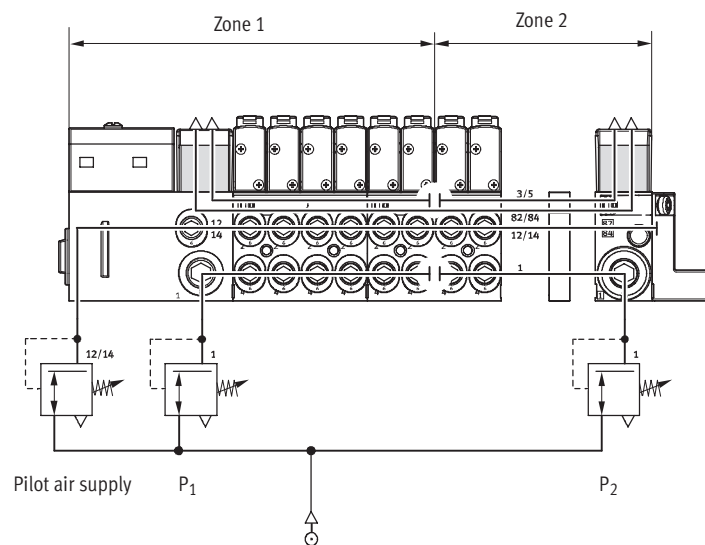

Valve terminals type 32 MPA

Key features – Pneumatic components



Manifold block

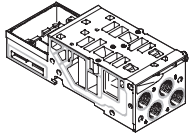

MPA is based on a modular system consisting of manifold blocks and valves. The manifold blocks are screwed together and thus form the support system for the valves. They contain the connection ducts for

supplying compressed air to and venting from the valve terminal as well as the working lines for the pneumatic drives for each valve. Each manifold block is connected to the next using three screws.

Individual terminal sections can be isolated and further manifold blocks inserted by loosening these screws. This ensures that the valve terminal can be rapidly and reliably extended.

Manifold block versions						
Code	Graphical symbol	Type	Size		Number of valve positions (solenoid coils)	Notes
			1	2		
Manifold block for multi-pin plug/fieldbus connection						
A, C*		VMPA1-FB-AP-4-1	■	-	4 (8/4*)	Working lines (2, 4) on the manifold block <ul style="list-style-type: none"> • Connection sizes: MPA1: M7, QS4, QS6 • Code I: Separation in duct 1 in the manifold block • Code III: Separation in duct 1 and duct 3/5 in the manifold block
AI, CI*		VMPA1-FB-AP-4-1-T1				
AIII, CIII*		VMPA1-FB-AP-4-1-S1				
B, D*		VMPA2-FB-AP-2-1	-	■	2 (4/2*)	Working lines (2, 4) on the manifold block <ul style="list-style-type: none"> • Connection sizes MPA2: G1/8, QS6, QS8 • Code I: Separation in duct 1 in the manifold block • Code III: Separation in duct 1 and duct 3/5 in the manifold block
BI, DI*		VMPA2-FB-AP-2-1-TO				
BIII, DIII*		VMPA2-FB-AP-2-1-SO				
Individual sub-base						
-		Without ATEX certification: VMPA1-1-IC-AP-1** VMPA1-1-IC-AP-S-1***	■	-	1 (2)	<ul style="list-style-type: none"> • With working lines MPA1: M7, QS4, QS6 • With ports for supply air (1, 12/14) and exhaust air (3, 5, 82/84) • For internal or external pilot air supply
		With ATEX certification: VMPA1-1-IC-AP-1-EX2** VMPA1-1-IC-AP-S-1-EX2***				
-		Without ATEX certification: VMPA2-IC-AP-1** VMPA2-IC-AP-S-1***	-	■	1 (2)	<ul style="list-style-type: none"> • With working lines MPA2: G1/8, QS6, QS8 • With ports for supply air (1, 12/14) and exhaust air (3, 5, 82/84) • For internal or external pilot air supply
		With ATEX certification: VMPA2-IC-AP-1-EX2** VMPA2-IC-AP-S-1-EX2***				

* Only possible with multi-pin plug connection

** Internal pilot air supply

*** External pilot air supply

Valve terminals type 32 MPA

Key features – Pneumatic components



Pressure sensor

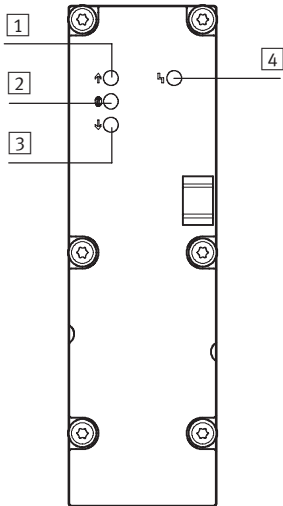

- 1 Red LED: Pressure exceeded
- 2 Green LED: Pressure adhered to
- 3 Red LED: Pressure fallen below
- 4 Red LED: Common error display

The pressure sensor indicates whether the applied pressure exceeds, adheres to or falls below the setpoint value using three LEDs. An additional LED indicates common errors (limit exceeded or fallen below).

The limits for pressure monitoring are set by means of parameter settings. You can parameterise the pressure sensor plate via the PLC or the handheld device (CPXMMI) from Festo.

Alternatively the pressure in the exhaust duct (3/5) and the process pressure (external) can be measured. Pressure measurement in the exhaust duct is used for monitoring the operating pressure during reversible operation (supply to (3/5)).

Pressure sensor versions

Code	Graphical symbol	Type	Application
PE		VMPA-FB-PS-1	Monitoring the operating pressure in duct 1
PF		VMPA-FB-PS-3/5	Monitoring the pressure in exhaust ducts 3 and 5 (monitoring the venting performance or monitoring pressure in the case of reversible valve terminals)
PG		VMPA-FB-PS-P1	Monitoring an external process pressure

Valve terminals type 32 MPA

Key features – Pneumatic components



Electrical interface versions						
Code	Graphical symbol	Type	Size		Number of valve positions (solenoid coils)	Notes
			1	2		
Electronics module for multi-pin plug (MPM)						
A, B, C, D		VMPA1-MPM-EMM-8 VMPA1-MPM-EMM-4	■	–	4 (8) 4 (4)	Each solenoid coil must be assigned to a specific pin of the multi-pin plug in order for the valve to be actuated. Regardless of the blanking plates or valves used, valve positions occupy <ul style="list-style-type: none"> • 1 address for actuation of 1 coil • 2 addresses for actuation of 2 coils
		VMPA2-MPM-EMM-4 VMPA2-MPM-EMM-2	–	■	2 (4) 2 (2)	
Electronics module for fieldbus with standard diagnostics						
A, B, H		VMPA...-FB-EMS-... VMPA...-FB-EMG-...	■	–	4 (8)	The electronics module contains the serial communication system and facilitates: <ul style="list-style-type: none"> • Transmission of switching information • Actuation of up to 8 solenoid coils • Position-based diagnostics • Separate voltage supply for valves There are different versions: <ul style="list-style-type: none"> • Without isolated electrical circuit (VMPA...-FB-EMS-...) • With isolated electrical circuit (VMPA...-FB-EMG-...) Diagnostic function: <ul style="list-style-type: none"> • Error: Load voltage of the valves
					2 (4)	
Electronics module for fieldbus with extended diagnostic function						
A, B, H		VMPA...-FB-EMS-...-D2 VMPA...-FB-EMG-...-D2	■	–	4 (8)	The electronics module with extended diagnostic function contains the same functions as the electronics module with standard diagnostics. The diagnostic function, however, has been extended: <ul style="list-style-type: none"> • Error: Load voltage of the valves • Error: Wire break (open load) • Error: Short circuit in load voltage of valves • Message: Condition monitoring
					2 (4)	

– Note

- Multi-pin plug with modular linking
- Manifold blocks MPA1 and MPA2 can be combined as required
- Positive or negative switching actuation is possible (mixed operation is not permitted)
- Double solenoid valves cannot be mounted on single solenoid electronics modules
- Single solenoid valves can be mounted on double solenoid electronics modules

Valve terminals type 32 MPA

Key features – Pneumatic components

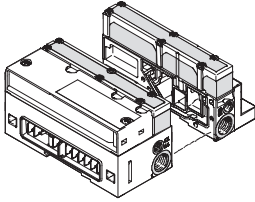
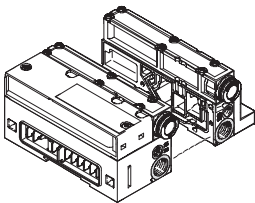
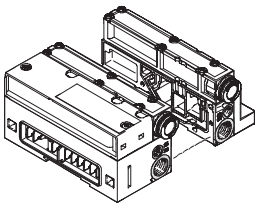
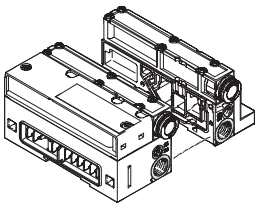

Ports for supply and exhaust							
Code		Port	Designation	Code L Large plug connector	Code K Small plug connector	Code D Thread for supply	
S		Internal pilot air supply, silencer					
		1	Supply air/ vacuum supply	Push-in fitting	QS-G $\frac{1}{4}$ -10-I	QS-G $\frac{1}{4}$ -8-I	G $\frac{1}{4}$
		3/5	Exhaust air	Flat plate silencer	–	–	–
		12/14	Pilot air supply	–	–	–	–
		82/84	Pilot exhaust air	Flat plate silencer	–	–	–
			Pressure compensation	Vents into the atmosphere via silencer			
T		External pilot air supply, silencer					
		1	Supply air/ vacuum supply	Push-in fitting	QS-G $\frac{1}{4}$ -10-I	QS-G $\frac{1}{4}$ -8-I	G $\frac{1}{4}$
		3/5	Exhaust air	Flat plate silencer	–	–	–
		12/14	Pilot air supply	Push-in fitting	QSM-M7-6-I	QSM-M7-6-I	M7
		82/84	Pilot exhaust air	Flat plate silencer	–	–	–
			Pressure compensation	Vents into the atmosphere via silencer			
V		Internal pilot air supply, ducted exhaust air					
		1	Supply air/ vacuum supply	Push-in fitting	QS-G $\frac{1}{4}$ -10-I	QS-G $\frac{1}{4}$ -8-I	G $\frac{1}{4}$
		3/5	Exhaust air	Push-in fitting	QS-10	QS-10	QS-10
		12/14	Pilot air supply	–	–	–	–
		82/84	Pilot exhaust air	Push-in fitting	QSM-M7-6-I	QSM-M7-6-I	M7
			Pressure compensation	Vents into duct 82/84			
X		External pilot air supply, ducted exhaust air					
		1	Supply air/ vacuum supply	Push-in fitting	QS-G $\frac{1}{4}$ -10-I	QS-G $\frac{1}{4}$ -8-I	G $\frac{1}{4}$
		3/5	Exhaust air	Push-in fitting	QS-10	QS-10	QS-10
		12/14	Pilot air supply	Push-in fitting	QSM-M7-6-I	QSM-M7-6-I	M7
		82/84	Pilot exhaust air	Push-in fitting	QSM-M7-6-I	QSM-M7-6-I	M7
			Pressure compensation	Vents into duct 82/84			

Valve terminals type 32 MPA

Key features – Assembly

Valve terminal assembly

Sturdy terminal assembly thanks to:

- Four through-holes for wall mounting
- Additional mounting brackets
- H-rail mounting



Note

When wall-mounting MPA valve terminals with more than 4 manifold blocks, use additional mounting brackets of the type VMPA-BG-RW to

prevent damage to the valve terminal. The mounting brackets can be mounted on the pneumatic supply plates.

Wall mounting – Multi-pin plug connection, AS-interface and CPI connection

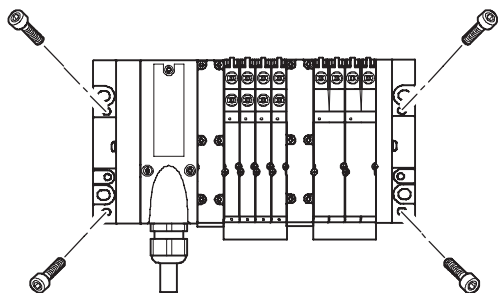

The MPA valve terminal is screwed onto the mounting surface using four M4 or M6 screws. The mounting holes are on the pneumatic interface

and on the right-hand end plate. There are also optional mounting brackets available.

Wall mounting – Fieldbus connection

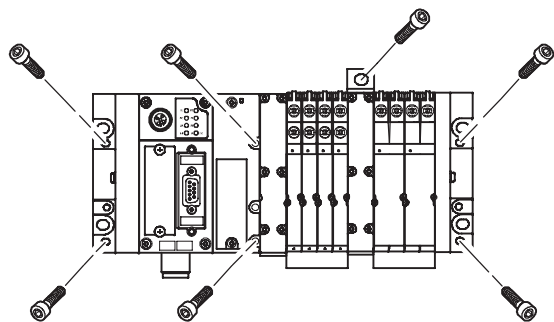

The MPA valve terminal is screwed onto the mounting surface using six M4 or M6 screws. The mounting holes are on the left-hand end plate (CPX) and on the right-hand end plate (MPA).

The pneumatic interface also provides further mounting holes as well as optional mounting brackets.

H-rail mounting

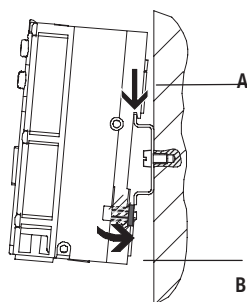

The MPA valve terminal is attached to the H-rail (see arrow A). The terminal is then swivelled around the H-rail and secured in place with the clamping component (see arrow B).

For H-rail mounting of the valve terminal you will need the following MPA mounting kit:

- With multi-pin plug: CPA-BG-NRH
- With fieldbus: CPX-CPA-BG-NRH

This enables mounting of the valve terminal on a H-rail to EN 60715.

Individual valve assembly

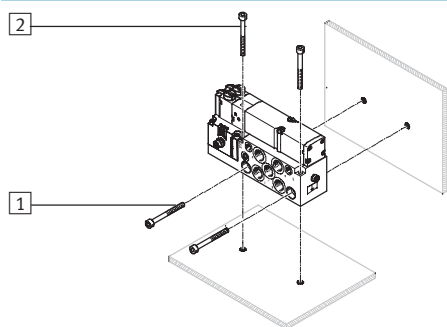

- 1 Horizontal mounting holes
- 2 Vertical mounting holes

The individual sub-base is designed for wall mounting or for integration into a system or machine. It can be mounted horizontally or vertically.

Valve terminals type 32 MPA

Key features – Display and operation



Display and operation

Each solenoid coil is allocated an LED that indicates its signal status.

- Indicator 12 shows the switching status of the coil for output 2
- Indicator 14 shows the switching status of the coil for output 4

Manual override

The manual override (MO) enables the valve to be actuated when not electrically activated or energised.

The valve is actuated by pushing the manual override. The set switching

status can also be locked by turning the manual override (code R or as accessory).

Alternatives:

- A cover (code N or as accessory) can be fitted over the manual override

to prevent it from being locked. The manual override can then only be activated by pushing it.

- A cover (code V) can be fitted over the manual override to prevent it from being accidentally activated.

Pneumatic connection and control elements

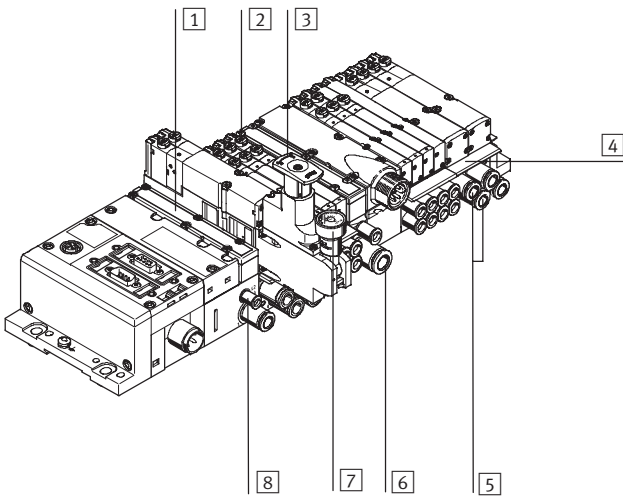

- 1 Flat plate silencer for exhaust port 3/5
- 2 Manual override (for each pilot solenoid coil, non-detenting or non-detenting/detenting)
- 3 Adjusting knob of optional pressure regulator plate
- 4 Inscription label holder for manifold block
- 5 Working lines 2 and 4, for each valve position
- 6 Supply port 1
- 7 Pressure gauge (optional)
- 8 Ports 12 and 14 for supplying the external pilot air

Note

A manually actuated valve (manual override) cannot be reset electrically. Conversely, an electrically actuated valve cannot be reset using the mechanical manual override.

Electrical connection and display components on the AS-interface

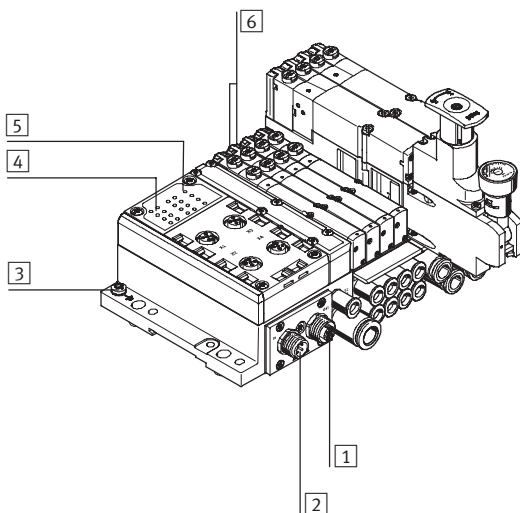

- 1 M12 socket for AS-interface bus and additional supply (AS-i Out)
- 2 M12 plug for AS-interface bus and additional supply (AS-i In)
- 3 Earth terminal
- 4 Status LEDs for inputs
- 5 Status LEDs for AS-interface
- 6 Diagnostic LEDs for valves

Valve terminals type 32 MPA

Key features – Display and operation

FESTO

Manual override (MO)

MO with automatic return (non-detenting)

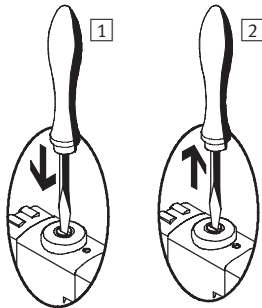

- 1 Press in the stem of the MO with a pin or screwdriver. Pilot valve switches and actuates the main valve.
- 2 Remove the pin or screwdriver. Spring force pushes the stem of the MO back. Pilot valve returns to its initial position and so too the single solenoid main valve (not with double solenoid valve code J).

MO set via turning (detenting)

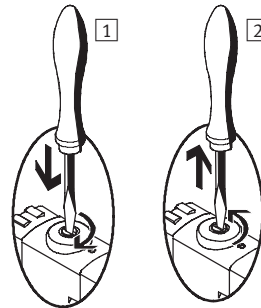

- 1 Press in the stem of the MO with a pin or screwdriver until the valve switches and then turn the stem clockwise by 90° until the stop is reached. Valve remains actuated.
- 2 Turn the stem anti-clockwise by 90° until the stop is reached and then remove the pin or screwdriver. Spring force pushes the stem of the MO back. Valve returns to its initial position (not with double solenoid valve code J).

Inscription system

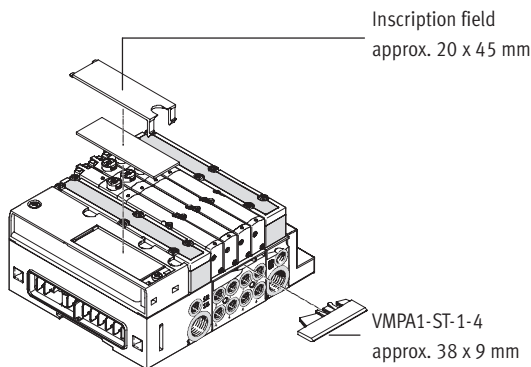

An inscription label holder VMPA1-ST-1-4 (Part No. 533 362, code T in the order code) or VMPA1-ST-2-4 (Part No. 544 384, for holding IBS-6x10 inscription labels) can be mounted on each manifold block with a width of 42 mm for labelling the valves.

Large inscription labels can be applied to the pneumatic interface as an alternative or complement to the smaller labels.

The following inscription labels can be used as spares:

- Inscription label MPA (20 x 45 mm): Part No. 663 010

Valve terminals type 32 MPA

Key features – Electrical components

Electrical power as a result of current reduction

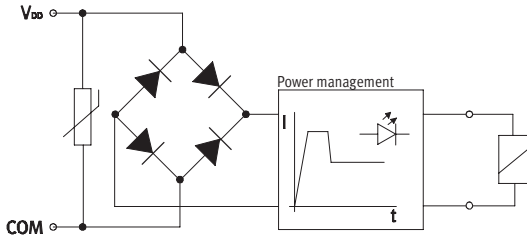

Each MPA solenoid coil is protected with a spark arresting protective circuit as well as against polarity reversal. All valve types are additionally equipped with integrated current reduction.

MPA valves are supplied with operating voltage in the range 18 ... 30 V (24 V +/-25%). This high tolerance is made possible through integrated control electronics and offers additional security, e.g. if the operating voltage drops.

Individual valve

Valves can also be used on individual sub-bases for actuators further away from the valve terminal.

- Detachable electronics module with integrated holding current reduction
- Electrical M8 connection, 4-pin with screw connection

Electrical multi-pin plug connection

The following multi-pin plug connection is offered for the valve terminal MPA:

- Sub-D multi-pin plug connection (25-pin)

Pins 1 ... 24 are used for addresses 1 ... 24 in order.

If fewer than 24 addresses are used for the valve terminal, the remaining

pins up to 24 are left free. Pin 25 is reserved for the neutral conductor. The valves are switched by means of positive or negative logic (PNP or NPN). Mixed operation is not permitted.

Each pin on the multi-pin plug can actuate exactly one solenoid coil. If the maximum configurable number

of valve positions is 24, this means that 24 valves can be addressed with one solenoid coil. With 12 or less valve positions, 2 solenoid coils per valve can be addressed. With 12 or more valve positions, the number of available valve positions for valves with two solenoid coils decreases.



Note

If a single solenoid valve is assembled on a double solenoid valve position, the second address is also occupied and cannot be used.

Guidelines on addressing for valves/solenoid coils

- The maximum possible number of addresses with a multi-pin plug connection is 24.
- Each manifold block/electronics module occupies a defined number of addresses/pins:
 - Manifold block MPA1 for 4 single solenoid valves: 4
 - Manifold block MPA2 for 2 double solenoid valves: 8
 - Manifold block MPA2 for 2 single solenoid valves: 2
 - Manifold block MPA2 for 2 double solenoid valves: 4
- The numbering of the addresses goes from left to right in ascending consecutive order. The following applies to the individual valve positions: address x for coil 14 and address x+1 for coil 12.
- If single solenoid valves are mounted on manifold blocks for double solenoid valves, the address of coil 12 and the assigned pin will remain unused.

Valve terminals type 32 MPA

Key features – Electrical components

AS-interface® fieldbus connection

The AS-interface facilitates the spatial distribution of individual components or small component groups.

The AS-interface connection of valve

terminal type 32 can be used to control up to 8 solenoid coils. The electrical connection of the valve

terminal contains the LEDs that indicate the operating status and the protective circuit for the valves.



Note

For further information see
 → Internet: as-interface

CPI fieldbus connection

All CP valve terminals and CP modules are connected using a ready-to-install CP cable, and are attached to the CP interface. Four modules, for example

one CPV valve terminal and one to three CP input modules, make up an installation string that ends at the CP interface. The installation system

supports a maximum of 4 installation strings that can be connected to a CP fieldbus node.



Note

For further information see
 → Internet: ctec

CPX fieldbus connection

All functions and features of the electrical peripherals CPX are supported in connection with the CPX interface. This means:

- The valves and electrical outputs are supplied via the operating voltage connection CPX
- The valves are supplied and disconnected separately via a separate valve connection on the CPX (code V)



Note

For further information see
 → Internet: cpx

Valve terminals type 32 MPA

Key features – Electrical components



Pin allocation – Sub-D socket, cable								
	Pin	Address/coil	Wire colour ²⁾		Pin	Address/coil	Wire colour ²⁾	
	1	0	WH		17	16	WH PK	
	2	1	GN		18	17	PK BN	
	3	2	YE		19	18	WH BU	
	4	3	GY		20	19	BN BU	
	5	4	PK		21	20	WH RD	
	6	5	BU		22	21	BN RD	
	7	6	RD		23	22	WH BK	
	8	7	VT		24	23	BN	
	9	8	GY PK		25	0 V ¹⁾	BK	
	10	9	RD BU		Note The drawing shows a view on the Sub-D socket on the multi-pin cable VMPA-KMS1-....			
	11	10	WH GN					
	12	11	BN GN					
	13	12	WH YE					
	14	13	YE BN					
	15	14	WH GY					
	16	15	GY BN					

- 1) 0 V for positive switching control signals; connect 24 V for negative switching control signals; mixed operation is not permitted.
 2) To IEC 757.

Dimensions

Connecting cable

Download CAD data → www.festo.com

1 Cable conduit fitting with clamping range 6 ... 12 mm

The wire colours refer to the following pre-assembled multi-pin cables from Festo:

- VMPA-KMS1-8-... Valve terminal for up to 4 valve positions (8 coils)
- VMPA-KMS1-24-... Valve terminal with 8 ... 24 valve positions

Type	Sheath	Length [m]	Core x mm ²	D [mm]	Part No.
VMPA-KMS1-8-2.5	PVC	2.5	10 x 0.34	6.9	533195
VMPA-KMS2-8-2.5-PUR	PUR	2.5	10 x 0.25	8.3	533504
VMPA-KMS1-8-5	PVC	5	10 x 0.34	6.9	533196
VMPA-KMS2-8-5-PUR	PUR	5	10 x 0.25	8.3	533505
VMPA-KMS1-8-10	PVC	10	10 x 0.34	6.9	533197
VMPA-KMS2-8-10-PUR	PUR	10	10 x 0.25	8.3	533506
VMPA-KMS1-24-2.5	PVC	2.5	25 x 0.34	11.4	533192
VMPA-KMS2-24-2.5-PUR	PUR	2.5	25 x 0.25	11.2	533501
VMPA-KMS1-24-5	PVC	5	25 x 0.34	11.4	533193
VMPA-KMS2-24-5-PUR	PUR	5	25 x 0.25	11.2	533502
VMPA-KMS1-24-10	PVC	10	25 x 0.34	11.4	533194
VMPA-KMS2-24-10-PUR	PUR	10	25 x 0.25	11.2	533503
VMPA-KMS-H	Cover for self-assembly				533198

Valve terminals type 32 MPA

Key features – Electrical components

Electrical connection – Individual valve interface

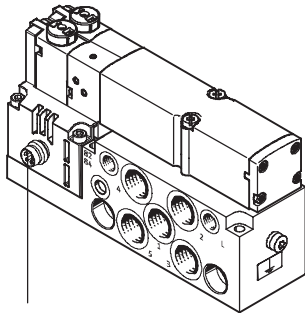

Connector plug M8 x 1, male, 4-pin to EN 60 947-5-2

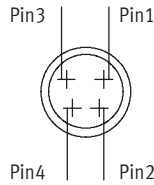

Pin allocation on individual valve to VDMA 24571

With positive logic:

- Pin1 – Not allocated
- Pin2 – V_0 for coil 12
- Pin3 – 0 V for coils 12 and 14
- Pin4 – V_0 for coil 14

With negative logic:

- Pin1 – Not allocated
- Pin2 – 0 V for coil 12
- Pin3 – V_0 for coils 12 and 14
- Pin4 – 0 V for coil 14

Tightening torque for M8 plug

0.25 ... 0.5 Nm (manual torque)

Connecting cable				
Type	Designation	Version	Cable length [m]	Part No.
SIM-M8-4GD-2,5-PU	Plug socket with cable	Straight socket	2.5	158960
SIM-M8-4GD-5-PU	Plug socket with cable	Straight socket	5	158961
SIM-M8-4WD-2,5-PU	Plug socket with cable	Angled socket	2.5	158962
SIM-M8-4WD-5-PU	Plug socket with cable	Angled socket	5	158963
NEBU-M8G4-K-2.5-LE4	Plug socket with cable	Straight socket	2.5	541342
NEBU-M8G4-K-5-LE4	Plug socket with cable	Straight socket	5	541343
NEBU-M8W4-K-2.5-LE4	Plug socket with cable	Angled socket	2.5	541344
NEBU-M8W4-K-5-LE4	Plug socket with cable	Angled socket	5	541345



 Note
Additional variants can be configured and ordered via the NEBU modular product system.
➔ Internet: nebu

Instructions for use

Equipment	Bio-oils	Mineral oils
Operate your equipment with unlubricated compressed air if possible. Festo valves and cylinders are designed so that, if used as designated, they will not require additional lubrication and will still achieve a long service life. The quality of compressed air downstream from the compressor must correspond to that of unlubricated compressed air. If possible, do not operate all of your equipment with lubricated compressed air. The lubricators should, where possible, always be installed directly upstream of the actuator used.	Unsuitable additional oil and an excessive oil content in the compressed air reduce the service life of the valve terminal. Use Festo special oil OFSW-32 or the alternatives listed in the Festo catalogue (as specified in DIN 51524 HLP32; basic oil viscosity 32 CST at 40 °C).	When using mineral oils (e.g. HLP oils to DIN 51524, parts 1 to 3) or similar oils based on poly-alpha-olefins (PAO), the maximum residual oil content of 5 mg/m ³ must not be exceeded (see ISO 8573-1 Class 4). A higher residual oil content irrespective of the compressor oil cannot be permitted, as the basic lubricant would be flushed out over time.

Valve terminals type 32 MPA

Technical data

-  - Flow rate
MPA1: Up to 360 l/min
MPA2: Up to 700 l/min
-  - Valve width
MPA1: 10 mm
MPA2: 21 mm
-  - Voltage
24 V DC

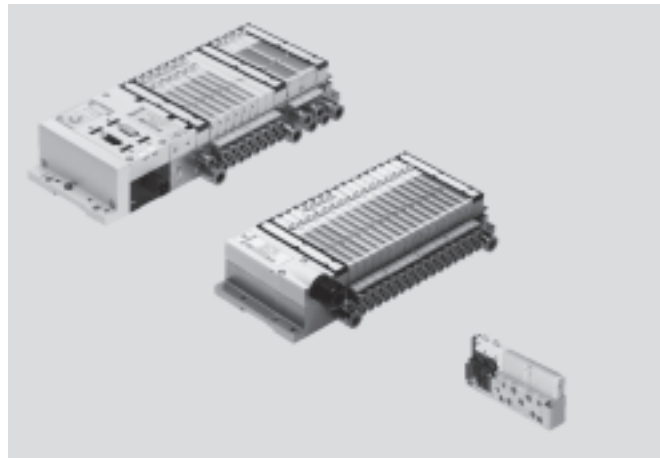

General technical data		MPA1	MPA2
Constructional design		Electromagnetically actuated piston spool valve	
Lubrication		Lubricated for life, PWIS-free (free of paint-wetting impairment substances)	
Type of mounting		Wall mounting On H-rail to EN 60715	
Mounting position		Any	
Manual override		Non-detenting, detenting, blocked	
Width	[mm]	10.5	21
Pneumatic connections			
Pneumatic connection		Via manifold block or individual connection	
Supply port	1	G $\frac{3}{4}$ (M7 with individual sub-base)	
Exhaust port	3/5	QS-10 (M7 with individual sub-base)	
Working lines	2/4	Depending on the connection type selected	
		<ul style="list-style-type: none"> • M7 • QS4 • QS6 	<ul style="list-style-type: none"> • G$\frac{1}{8}$ • QS6 • QS8
Pilot air port	12/14	M7 (M5 with individual sub-base)	
Pilot exhaust port	82/84	M7 (M5 with individual sub-base)	
Pressure compensation port		With ducted exhaust air: via port 82/84 (M5 with individual sub-base) With flat plate silencer: venting to atmosphere	

Valve terminals type 32 MPA

Technical data

Operating and environmental conditions		M	J	N	K	H	B	G	E	X	W	D	I	NS	KS	HS	DS	
Valve function order code																		
Operating medium		Filtered compressed air, lubricated or unlubricated, inert gases → 49																
Grade of filtration	[µm]	40																
Operating pressure	[bar]	-0.9 ... +10			3 ... 10			-0.9 ... +10			3 ... 10			-0.9 ... +8				
Operating pressure for valve terminal with internal pilot air supply	[bar]	3 ... 8																
Pilot pressure	[bar]	3 ... 8																
Ambient temperature	[°C]	-5 ... +50																
Temperature of medium	[°C]	-5 ... +50																
Storage temperature ¹⁾	[°C]	-20 ... +40																
Relative air humidity at 40 °C	[%]	90																
Corrosion resistance class CRC ²⁾		1																

- 1) Long-term storage
- 2) Corrosion resistance class 1 as per Festo standard 940 070
Components requiring low corrosion resistance. Transport and storage protection. Parts that do not have primarily decorative surface requirements, e.g. in internal areas that are not visible or behind covers.

Pilot pressure p₂ as a function of working pressure p₁ with external pilot air supply

for valves with code M, J, B, G, E, X

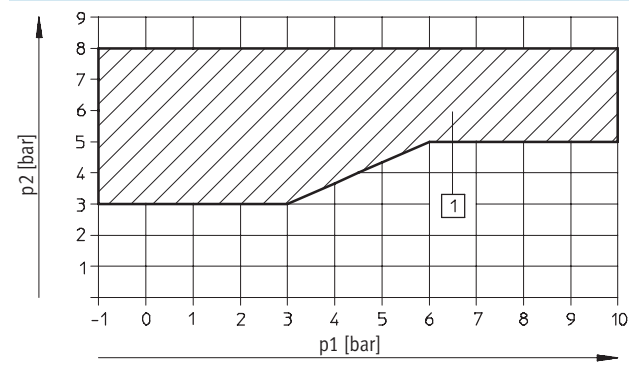

1) Operating range for valves with external pilot air supply

for valves with code N, K, H, D, I

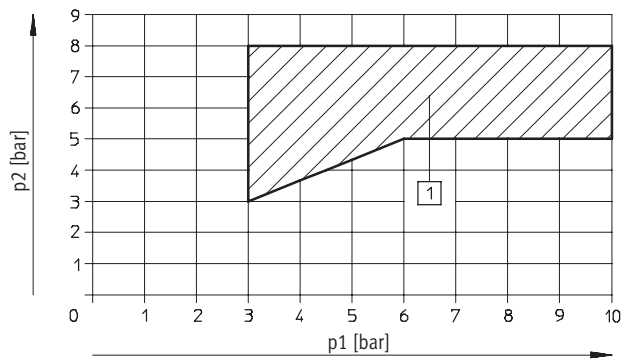

1) Operating range for valves with external pilot air supply

Valve terminals type 32 MPA

Technical data

Pilot pressure p_2 as a function of working pressure p_1 for valves with mechanical spring return (MPA1)

for valves with code NS, KS, HS, DS

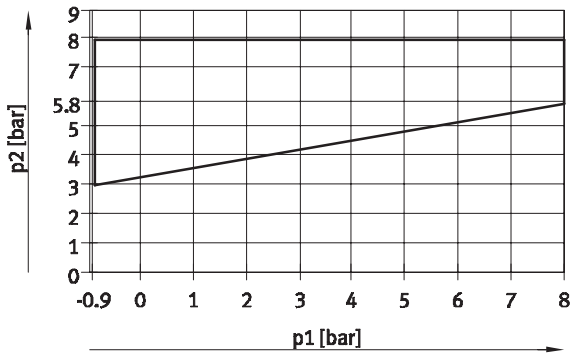

Flow rate q_n as a function of output pressure p_2 with pressure regulator plates (P regulator plate) for port 1

Width 21 mm

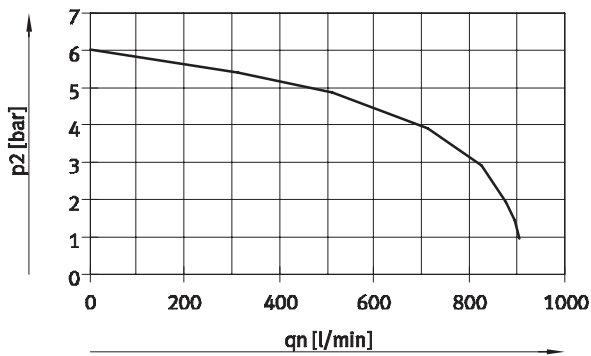

Supply pressure 10 bar,
set regulator pressure 6 bar

Flow rate q_n as a function of output pressure p_2 with pressure regulator plates (B regulator plates) for port 2

Width 21 mm

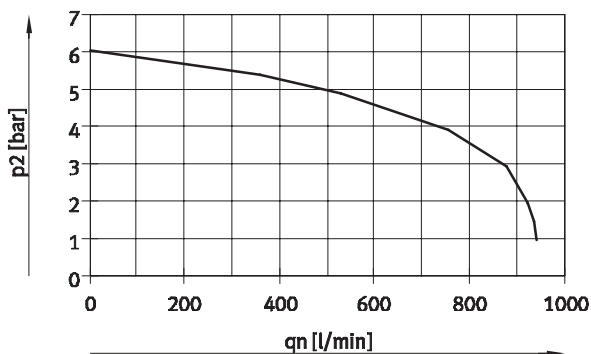

Supply pressure 10 bar,
set regulator pressure 6 bar

Valve terminals type 32 MPA

Technical data

Flow rate q_n as a function of output pressure p_2 with pressure regulator plates (A regulator plates) for ports 4

Width 21 mm

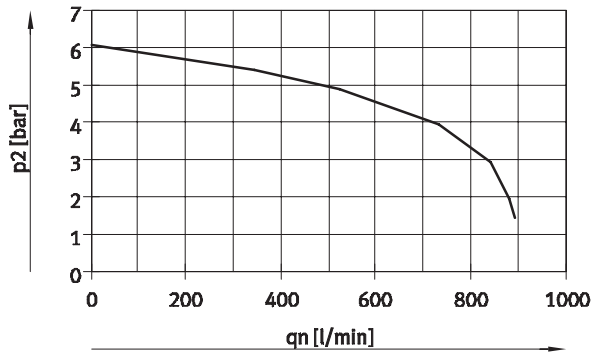

Supply pressure 10 bar,
set regulator pressure 6 bar

Flow rate q_n as a function of output pressure p_2 with pressure regulator plates (B regulator plates, rev.) for ports 3, reversible

Width 21 mm

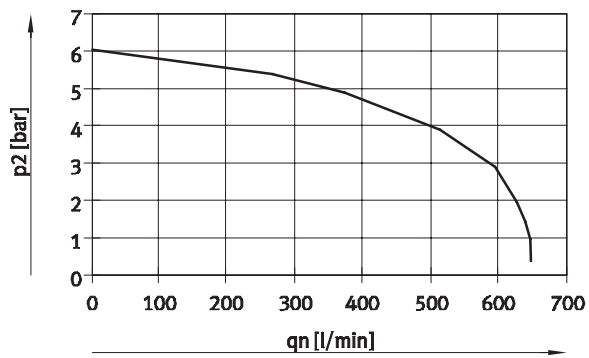

Supply pressure 10 bar,
set regulator pressure 6 bar

Flow rate q_n as a function of output pressure p_2 with pressure regulator plates (A regulator plates, rev.) for ports 5, reversible

Width 21 mm

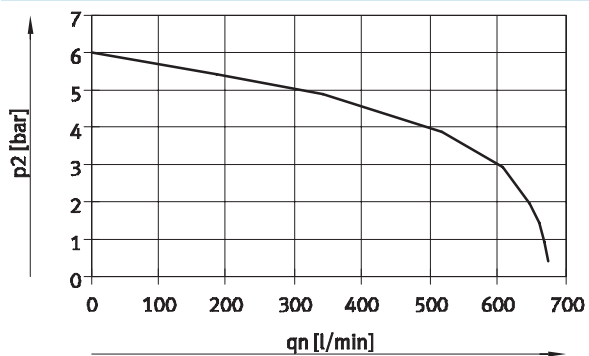

Supply pressure 10 bar,
set regulator pressure 6 bar

Valve terminals type 32 MPA

Technical data

FESTO

Certifications ¹⁾			
Type	MPA-MPM-VI (VI with multi-pin connection)	MPA-FB-VI (VI with fieldbus connection)	Valve on individual sub-base ²⁾
Part No.	539105	530411	→ 68
ATEX category gas	II 3 G		
Ex-ignition protection type gas	Ex nA II T4 X		
ATEX category dust	II 3D		
EX-ignition protection type dust	Ex tD A22 IP54 T95°C X		
ATEX ambient temperature [°C]	-5 ≤ Ta ≤ +50		
Certification	c UL us - Recognized (OL)		

- 1) Unlisted interface variants (e.g. CPI interface or AS interface) do not include the listed certifications
 2) Applies only to sub-bases VMPA... - EX1

Nominal flow rate [l/min] ¹⁾					
Code	Valve function	Without fitting		With fitting ²⁾	
		from port 1 to 2, or 1 to 4	from port 2 to 3/5, or 4 to 3/5	from port 1 to 2, or 1 to 4	from port 2 to 3/5, or 4 to 3/5
MPA1					
M	5/2-way valve, single solenoid	360	360	360	360
J	5/2-way valve, double solenoid	360	360	360	360
N	2x 3/2-way valve, normally open	300	300	300	300
NS	2x 3/2-way valve, normally open, mechanical spring return	300	300	300	300
K	2x 3/2-way valve, normally closed	230	310	230	310
KS	2x 3/2-way valve, normally closed, mechanical spring return	230	310	230	310
H	2x 3/2-way valve, 1x normally open, 1x normally closed	280	305	280	305
HS	2x 3/2-way valve, 1x normally open, 1x normally closed, mechanical spring return	300	305	300	305
B	5/3-way valve, mid-position pressurised	300 (195) ³⁾	270	300 (195) ³⁾	270
G	5/3-way valve, mid-position closed	320	320	320	320
E	5/3-way valve, mid-position exhausted	240	240 (180) ³⁾	240	240 (180) ³⁾
X	1x 3/2-way valve	255	295	255	295
W	1x 3/2-way valve	255	295	255	295
D	2x 2/2-way valve	230	230	230	230
DS	2x 2/2-way valve, mechanical spring return	230	-	230	-
I	2x 2/2-way valve	260	260	230	260
MPA2					
M	5/2-way valve, single solenoid	700	700	660	670
J	5/2-way valve, double solenoid	700	700	660	670
N	2x 3/2-way valve, normally open	560	490	550	480
K	2x 3/2-way valve, normally closed	500	560	500	540
H	2x 3/2-way valve, 1x normally open, 1x normally closed	500	490	500	480
B	5/3-way valve, mid-position pressurised	520	650 (350) ³⁾	510	600 (350) ³⁾
G	5/3-way valve, mid-position closed	630	630	600	610
E	5/3-way valve, mid-position exhausted	610	440 (350) ³⁾	590	420 (350) ³⁾
X	1x 3/2-way valve	500	590	470	560
W	1x 3/2-way valve	500	590	470	560
D	2x 2/2-way valve	680	-	650	-
I	2x 2/2-way valve	680	500	650	500

- 1) Values also apply to individual sub-bases
 2) Flow rates measured on manifold block with fitting QS-M7-6-I for MPA1 and QS-G¹/₈-8-I for MPA2
 3) Value for mid-position

Valve terminals type 32 MPA

Technical data

Valve switching times [ms]																	
Valve function order code		M	J	N	K	H	B	G	E	X	W	D	I	NS	KS	HS	DS
MPA1																	
Switching times	on	10	10	10	10	10	10	10	10	10	10	10	10	14	14	14	14
	off	20	–	20	20	20	35	35	35	20	20	20	20	16	16	16	16
	change-over	–	15	–	–	–	–	–	–	–	–	–	–	–	–	–	–
MPA2																	
Switching times	on	15	9	8	8	8	11	10	11	13	13	7	7	–	–	–	–
	off	28	–	28	28	28	46	40	47	22	22	25	25	–	–	–	–
	change-over	–	22	–	–	–	23	21	23	–	–	–	–	–	–	–	–

Valve terminals type 32 MPA

Technical data

Electrical data		
	MPA1	MPA2
Nominal voltage	[V DC]	24
Operating voltage range	[V DC]	18 ... 30
Residual ripple	[Vss]	4
Protection class to EN 60529	IP65 (for all types of signal transmission in assembled state)	

Electrical data – MPA with electronics module VMPA...-FB... (CPX terminal, CPI interface)			
Intrinsic current consumption per electronics module			
At 24 V $V_{EL/SEN}^{1)}$ (internal electronics, all outputs 0 signal)	[mA]	Typically 8	
At 24 V $V_{val}^{2)}$ (internal electronics, without valves)			
VMPA...-EMG..., electrical isolation	[mA]	Typically 23 mA	
VMPA...-EMS..., without electrical isolation	[mA]	Typically 3 mA	
Max. current consumption per solenoid coil at nominal voltage			
Nominal pick-up current	[mA]	58	99
Nominal current following current reduction	[mA]	9	18
Time until current reduction	[ms]	24	24
Diagnostic message			
Undervoltage $V_{OFF}^{3)}$	[V]	17.5 ... 16	

Electrical data – MPA with electronics module VMPA...-MPM... (AS-interface, multi-pin plug)			
Current consumption at Sub-D multi-pin plug connection per solenoid coil at nominal voltage			
Nominal pick-up current	[mA]	80	100
Nominal current following current reduction	[mA]	25	20
Time until current reduction	[ms]	25	50

Calculation example on the current consumption (CPX terminal, CPI interface)		
Current consumption with two solenoid coils MPA2 switched in parallel and one electronics module VMPA...-EMS..., without electrical isolation	[mA]	$I_{EL/SEN} = 8$
Nominal pick-up current (duration 24 ms)	[mA]	$I_{VAL} = 3$ (intrinsic current consumption of electronics module) + 2 x 99 (MPA2) = 202
Nominal current with current reduction (after 24 ms)	[mA]	$I_{VAL} = 3$ (intrinsic current consumption of electronics module) + 2 x 18 (MPA2) = 39

- 1) Power supply for the electronics and sensors
- 2) Load voltage supply for valves
- 3) Load voltage outside function range

Valve terminals type 32 MPA

Technical data

Data on vibration and shock in accordance with DIN/IEC68	
	MPA1 MPA2
Vibration ¹⁾	Tested to DIN/IEC68 / EN 60068 Parts 2 ... 6 With horizontal H-rail mounting: Severity level 1 With wall mounting: ²⁾
Shock ¹⁾	Tested to DIN/IEC68 / EN 60068 Parts 2 ... 27 With horizontal H-rail mounting: Severity level 1 With wall mounting: Severity level 1 ... ²⁾
Continuous shock	Tested to DIN/IEC68 / EN 60068 Parts 2 ... 29 With wall and H-rail mounting: Severity level 1

- 1) See the CPX System manual for information on vibrations and shock for the CPX terminal.
 2) Valve terminal MPA with MPM connection and more than 5 manifold blocks: Severity level 1
 Valve terminal MPA with CPX terminal or MPM connection and
 up to 5 manifold blocks without additional attachments: Severity level 2
 6 or more manifold blocks without additional mounting (wall bracket) after 2 to max. 4 manifold blocks: Severity level 2

Test conditions			
Severity level	Vibration	Shock	Continuous shock
1	0.15 mm travel at 10 ... 58 Hz, 2 g acceleration at 58 ... 150 Hz	±15 g at 11 ms duration, 5 shocks per direction	±15 g at 6 ms duration, 1000 shocks per direction
2	0.35 mm travel at 10 ... 60 Hz, 5 g acceleration at 60 ... 150 Hz	±30 g at 11 ms duration, 5 shocks per direction	–
Continuous shock resistance	To DIN/IEC 68/EN 60068, Parts 2-29: +/-15 g at 6 ms, 1000 cycles		

Valve terminals type 32 MPA

Technical data

FESTO

Materials	
Manifold block	Die-cast aluminium
Valve	Die-cast aluminium
Seals	NBR, elastomer
Supply plate	Die-cast aluminium
Right-hand end plate	Die-cast aluminium
Left-hand pneumatic interface	Die-cast aluminium, polyamide
Exhaust plate	Polyamide
Flat plate silencer	Polyethylene
Electrical supply plate	Housing: die-cast aluminium Cover: reinforced polyamide
Electronics module	Polycarbonate
Electrical manifold module	Bronze/polybutylene terephthalate
Regulator plate	Control section, housing: polyamide; seals: nitrile rubber

Product weight		
Approx. weight	[g]	
	MPA1	MPA2
Manifold block basic weight ¹⁾	400 (4 valve positions)	400 (2 valve positions)
Manifold block ¹⁾	185	
Individual sub-base	45	
Per valve M, X, W	49	100
Per valve J, N, K, H, B, G, E, D	56	100
Per valve KS, NS, HS, DS	56	-
Per vacant position L	24	44
Right-hand end plate	55	
Left-hand pneumatic interface ¹⁾		
• With flat plate silencer	315	
• With ducted exhaust air	324	
Supply plate ¹⁾		
• With flat plate silencer	111	
• With ducted exhaust air	120	
Electrical supply plate	200	
Regulator plate (MPA2)	180	
QSM-M5-3-l	3	
QSM-M5-4-l	4	
QSM-M5-6-l	5	
QSM-M7-4-l	6	
QSM-M7-6-l	5	
QS-G $\frac{1}{8}$ -6-l	22	
QS-G $\frac{1}{8}$ -8-l	13	
QS-G $\frac{1}{4}$ -8-l	22	
QS-G $\frac{1}{4}$ -10-l	23	

1) With sheet metal seal, inscription label holder, screws

Valve terminals type 32 MPA

Technical data

Dimensions

Download CAD data → www.festo.com

MPA1 valve on individual sub-base

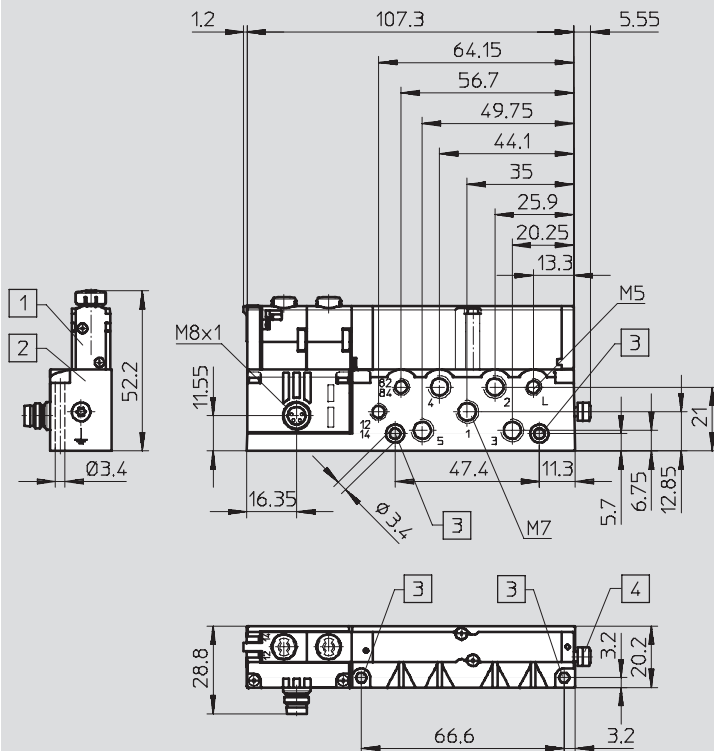

- 1 Solenoid valve
- 2 Individual sub-base
- 3 4x mounting holes for screw M3
- 4 Earthing screw

MPA2 valve on individual sub-base

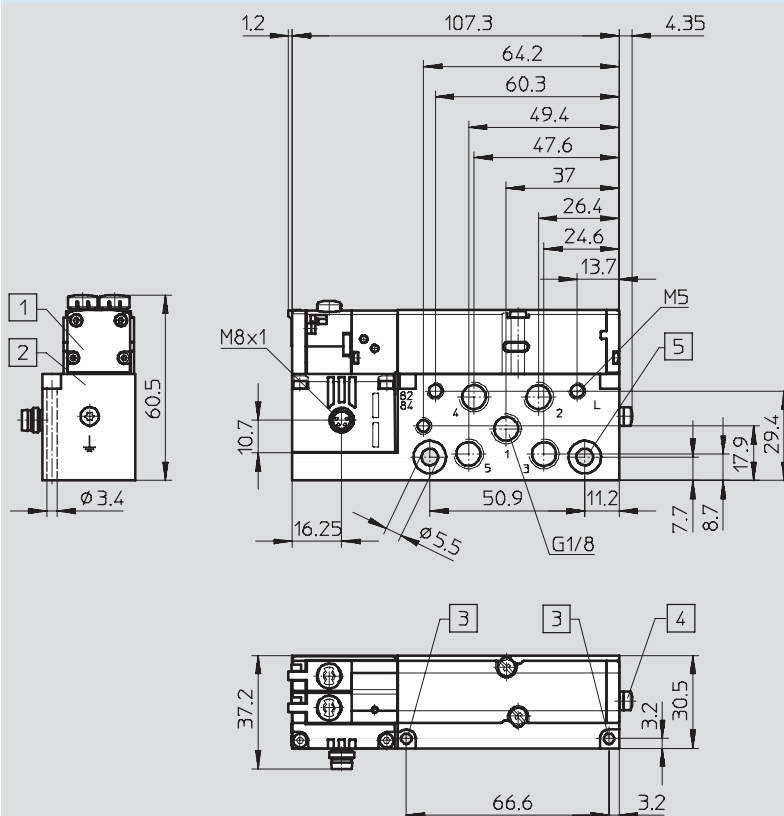

- 1 Solenoid valve
- 2 Individual sub-base
- 3 2x mounting holes for screw M3
- 4 Earthing screw
- 5 2x mounting holes for screw M5

Valve terminals type 32 MPA

Technical data

FESTO

Dimensions

Download CAD data → www.festo.com

Valve terminal with multi-pin plug connection

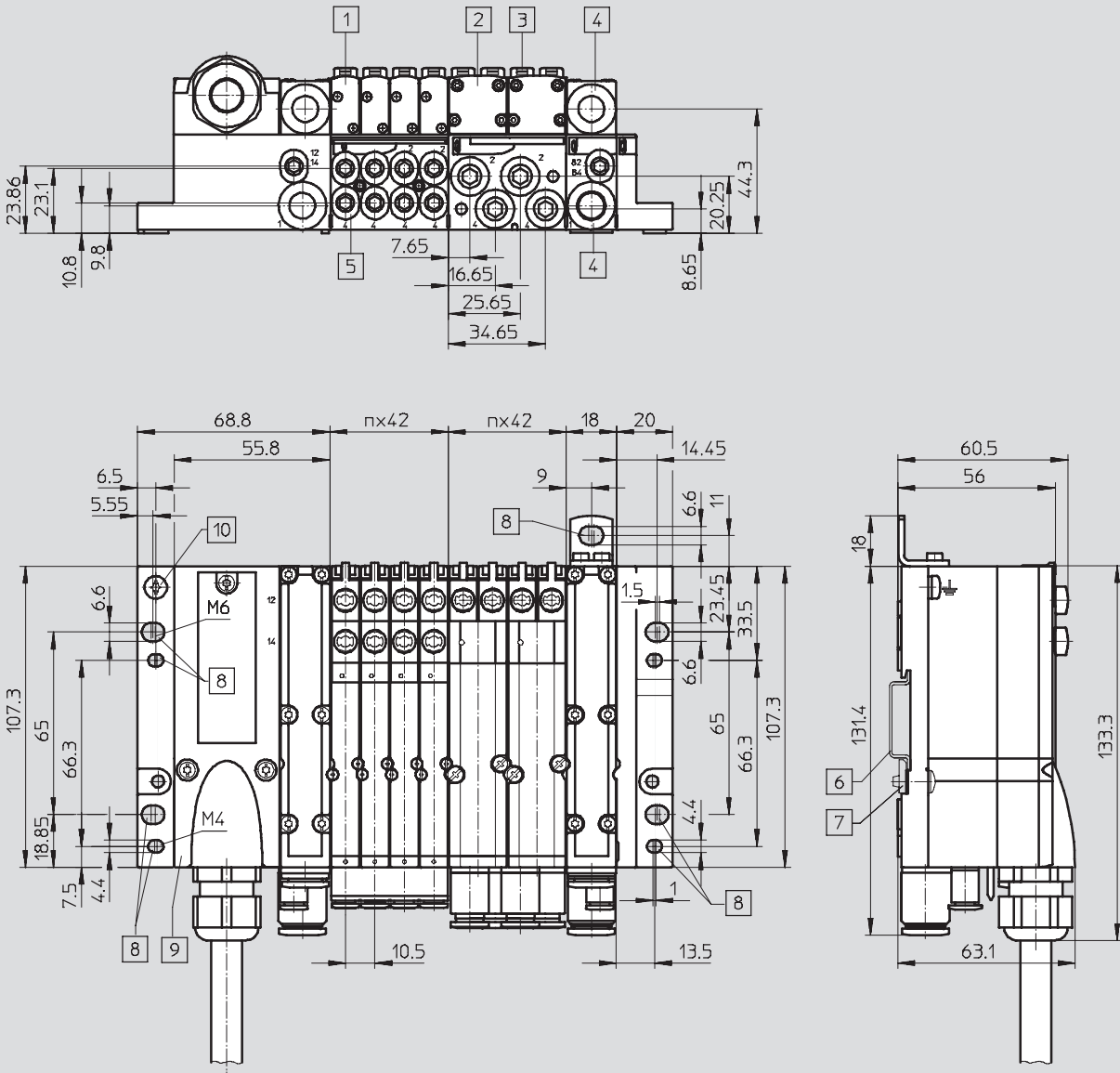

- | | | | |
|------------------------|-------------------|-----------------------------|--|
| 1 Solenoid valve MPA1 | 5 Working lines | 9 Multi-pin plug connection | n Number of manifold blocks in a grid of 4 MPA1 or 2 MPA2 valves |
| 2 Solenoid valve MPA2 | 6 H-rail | 10 Earthing screw | |
| 3 Manual override | 7 H-rail mounting | 11 Electrical supply plate | |
| 4 Supply/exhaust ports | 8 Mounting holes | | |

Valve terminals type 32 MPA

Technical data

Dimensions

Download CAD data → www.festo.com

Valve terminal with AS-interface connection

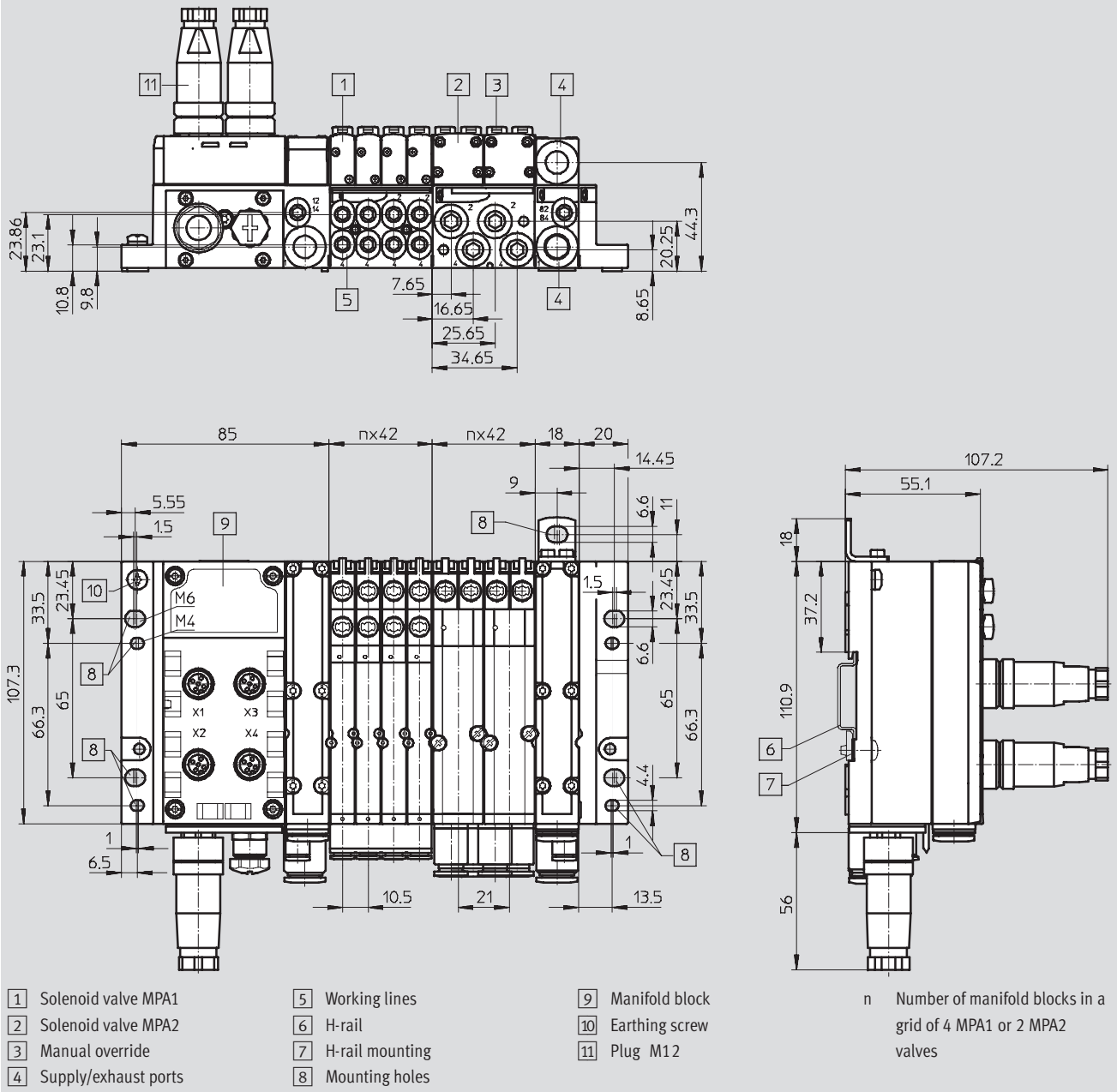

Valve terminals type 32 MPA

Technical data

FESTO

Dimensions

Download CAD data → www.festo.com

Valve terminal with CPI connection

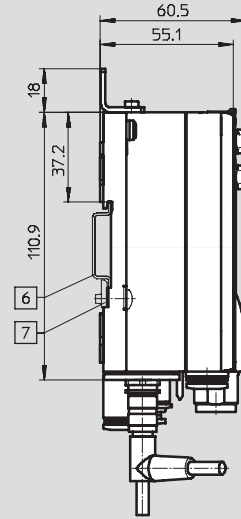
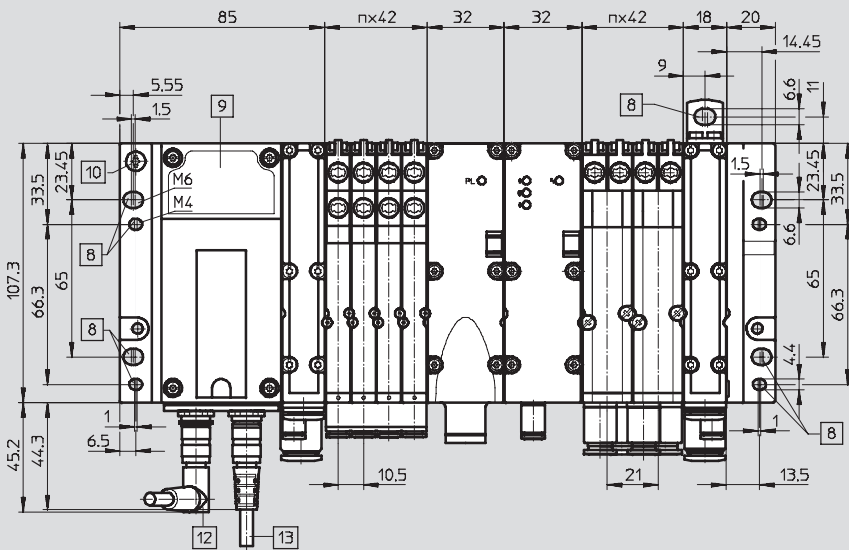
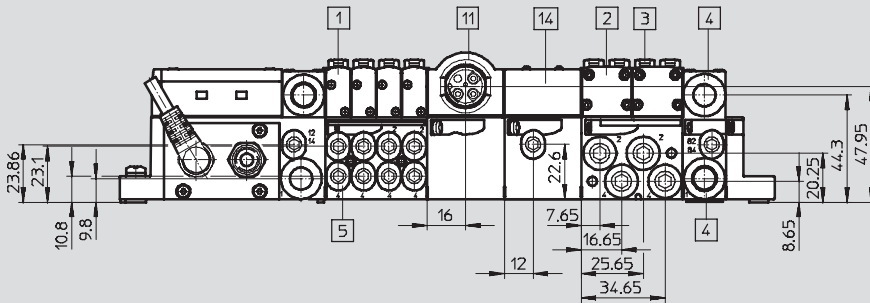

- | | | | |
|------------------------|----------------------------|--|--|
| 1 Solenoid valve MPA1 | 7 H-rail mounting | 12 Connecting cable with angled plug | n Number of manifold blocks in a grid of 4 MPA1 or 2 MPA2 valves |
| 2 Solenoid valve MPA2 | 8 Mounting holes | 13 Connecting cable with straight plug | |
| 3 Manual override | 9 Manifold block | 14 Pressure sensor | |
| 4 Supply/exhaust ports | 10 Earthing screw | | |
| 5 Working lines | 11 Electrical supply plate | | |
| 6 H-rail | | | |

Valve terminals type 32 MPA

Technical data

Dimensions

Download CAD data → www.festo.com

Valve terminal with fieldbus connection

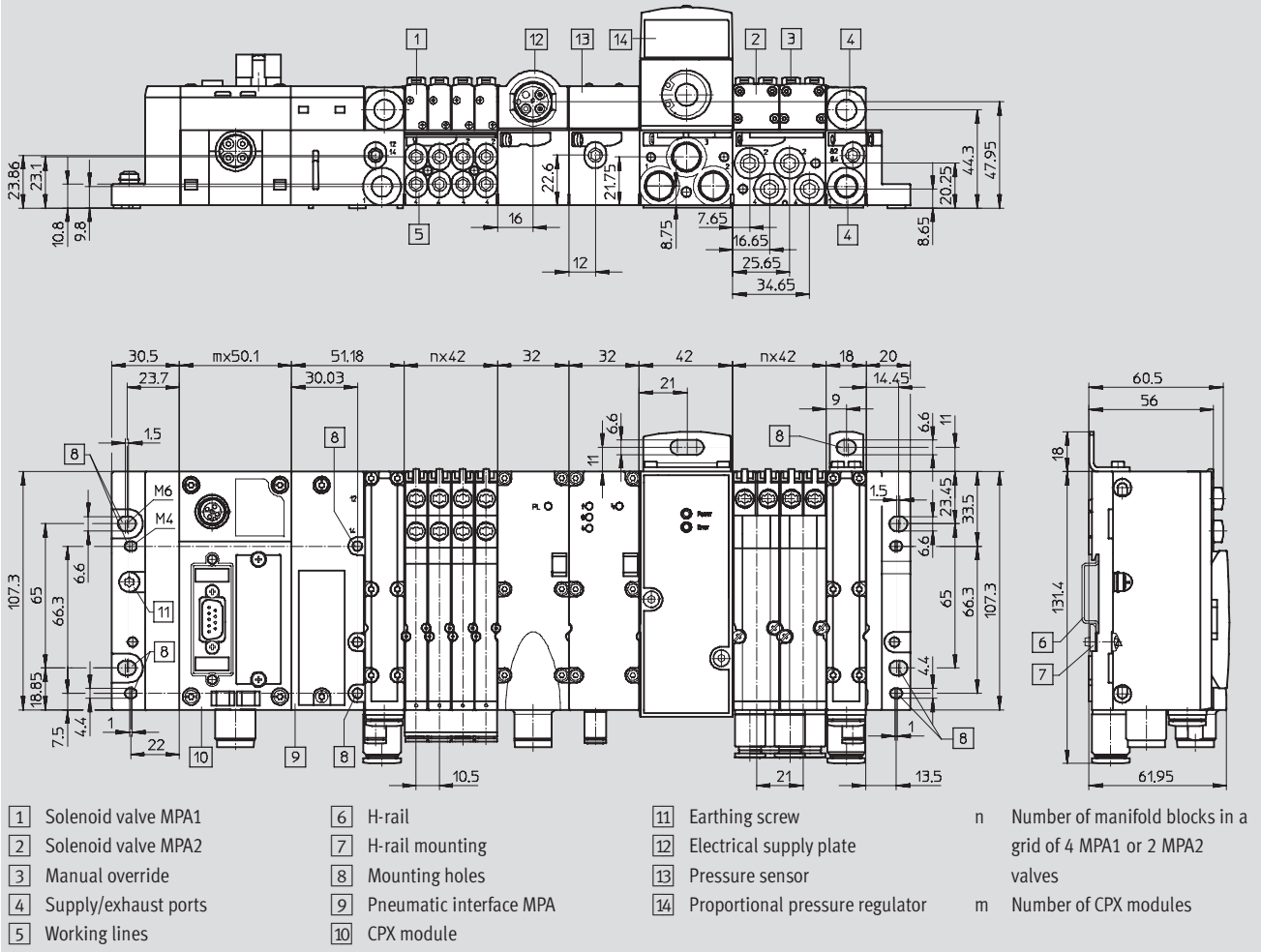

Vertical stacking components, MPA2

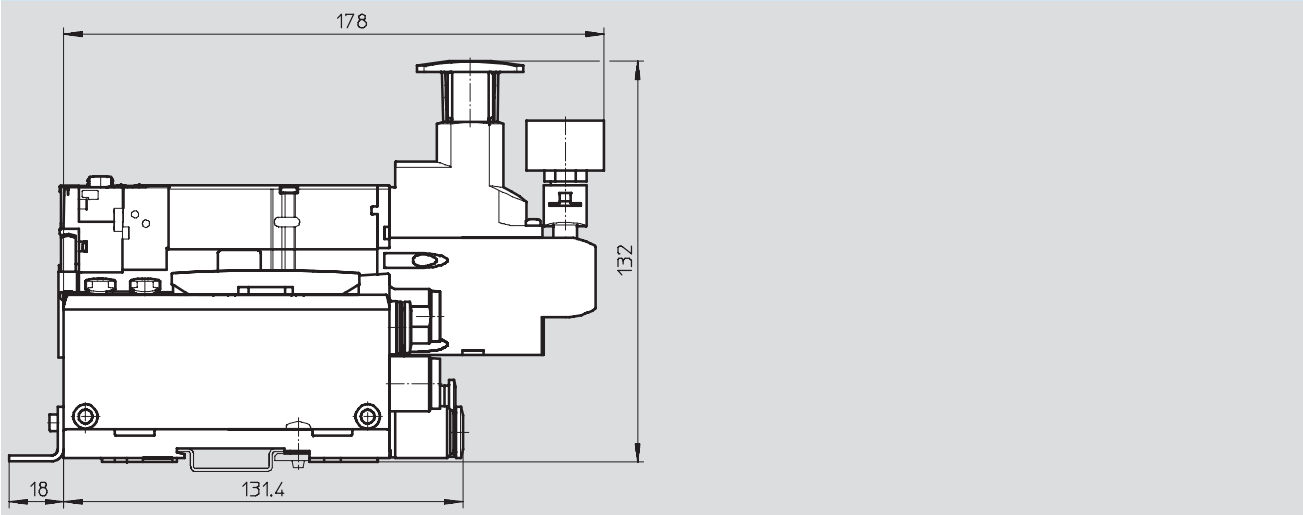



Valve terminals type 32 MPA

Technical data – Proportional pressure regulator VPPM

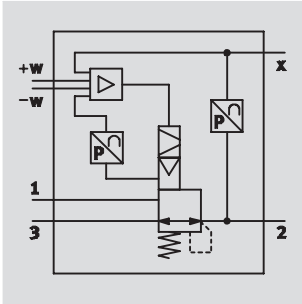
Function:



-  - Flow rate
380 ... 1,400 l/min
-  - Pressure regulation range
0.02 ... 10 bar
-  - Voltage
21.6 ... 26.4 V DC



General technical data		
Constructional design		Pilot actuated diaphragm regulator
Sealing principle		Soft
Actuation type		Electrical
Type of control		Pilot actuated
Mounting position		Any
Reset method		Mechanical spring
Pneumatic connection	1, 2, 3	Manifold block
Nominal diameter	Pressurisation	[mm] 6
	Exhaust	[mm] 4.5
Standard nominal flow rate	2 bar type	[l/min] 380
	6 bar type	[l/min] 900
	10 bar type	[l/min] 1,400
Product weight		[g] 400
Material	Housing	Wrought aluminium alloy, anodised

Electrical data		
Electrical connection		Via manifold block
Operating voltage range	[V DC]	21.6 ... 26.4
Residual ripple		10%
Max. electrical power consumption	[W]	7
Protection against short circuit		For all electrical connections
Protection against polarity reversal		For all electrical connections
Protection class to EN 60529		IP65

Valve terminals type 32 MPA

Technical data – Proportional pressure regulator VPPM

Flow rate q_n from 1 → 2 as a function of output pressure p_2

VPPM-6TA-...-0L2H-... (2 bar)

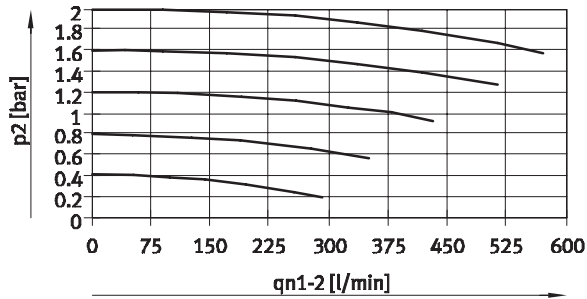

VPPM-6TA-...-0L6H-... (6 bar)

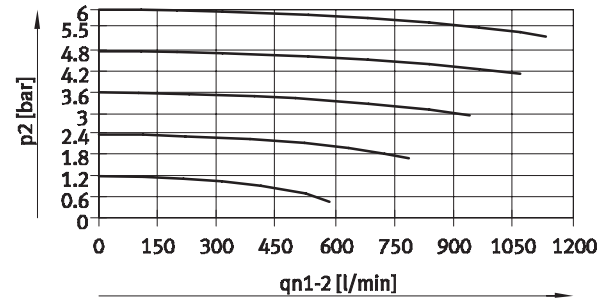

VPPM-6TA-...-0L10H-... (10 bar)

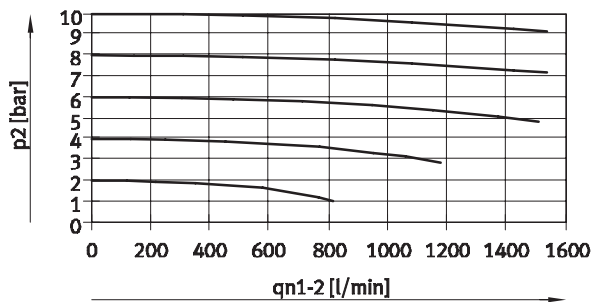

Flow rate q_n from 2 → 3 as a function of output pressure p_2

VPPM-6TA-...-0L2H-... (2 bar)

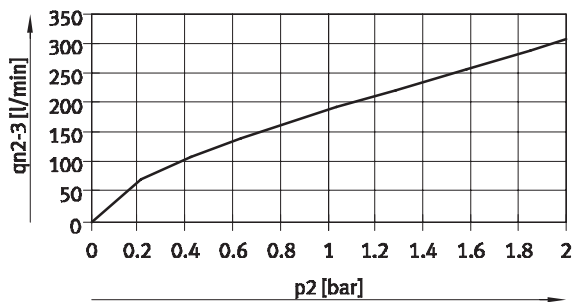

VPPM-6TA-...-0L6H-... (6 bar)

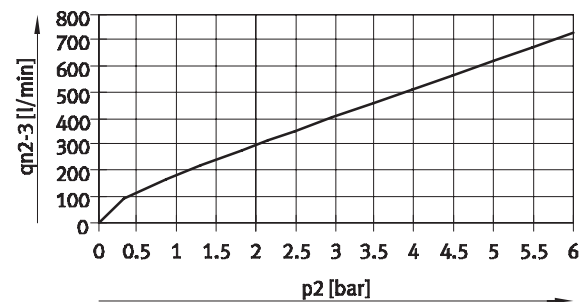

VPPM-6TA-...-0L10H-... (10 bar)

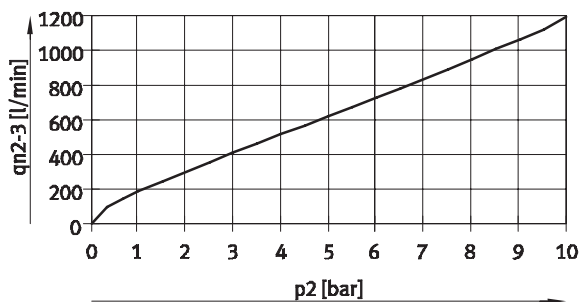

Valve terminals type 32 MPA

Technical data – Proportional pressure regulator VPPM

Operating and environmental conditions			VPPM-6TA-...-OL2H-...	VPPM-6TA-...-OL6H-...	VPPM-6TA-...-OL10H-...
Pressure regulation range	[bar]		0.02 ... 2	0.06 ... 6	0.1 ... 10
Operating medium			Compressed air, filtered, unlubricated, grade of filtration 40µm, neutral gases		
Supply pressure 1	[bar]		0 ... 4 ²⁾	0 ... 8 ²⁾	0 ... 11 ²⁾
Max. pressure hysteresis	[bar]		0.01	0.03	0.05
Linearity error FS (full scale)	Standard	[%]	2		
	Type S1	[%]	1		
Repetition accuracy FS (full scale)	[%]		0.5		
Temperature coefficient	[%/K]		0.04		
Ambient temperature	[°C]		0 ... 60		
Temperature of medium	[°C]		10 ... 50		
Corrosion resistance class CRC ¹⁾			2		
CE mark (see declaration of conformity)			To EU EMC Directive		

- 1) Corrosion resistance class 2 as per Festo standard 940 070
Components subject to moderate corrosion stress. Externally visible parts with primarily decorative surface requirements which are in direct contact with a normal industrial environment or media such as coolants or lubricating agents.
- 2) The supply pressure 1 should always be 1 bar greater than the maximum regulated output pressure.

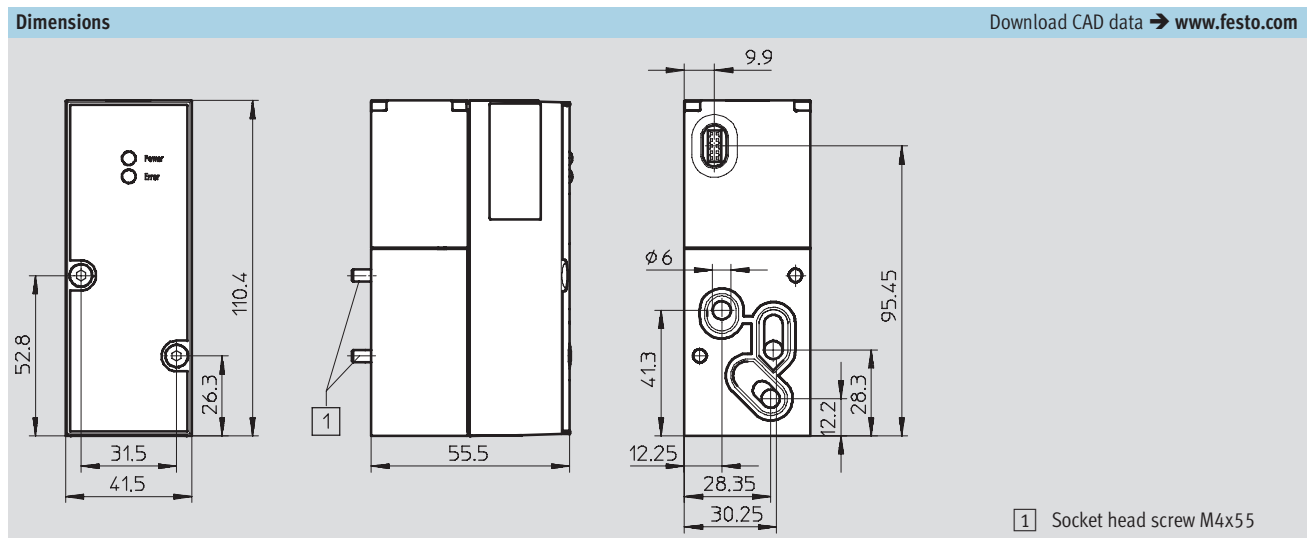

Valve terminals type 32 MPA

Technical data – Proportional pressure regulator VPPM

Ordering data					
Code	Overall accuracy	Supply pressure 1 [bar]	Pressure regulation range [bar]	Type	Part No.
QA	2%	0 ... 4	0.02 ... 2	VPPM-6TA-L-1-F-0L2H	542220
QD	1%			VPPM-6TA-L-1-F-0L2H-S1	542217
QB	2%	0 ... 8	0.06 ... 6	VPPM-6TA-L-1-F-0L6H	542221
QE	1%			VPPM-6TA-L-1-F-0L6H-S1	542218
QC	2%	0 ... 11	0.1 ... 10	VPPM-6TA-L-1-F-0L10H	542222
QF	1%			VPPM-6TA-L-1-F-0L10H-S1	542219

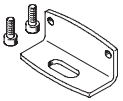
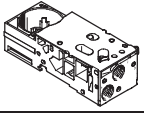
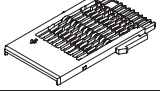
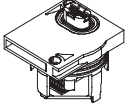
Ordering data – Accessories			
Designation		Type	Part No.
	Mounting	VMPA-BG	558844
	Manifold block without electrical manifold module and without electrical module	VMPA-FB-AP-P1	542223
	Electrical manifold module for manifold block of the proportional pressure regulator	VMPA1-FB-EV-AB	537998
	Electrical module	VMPA-FB-EMG-P1	542224

Valve terminals type 32 MPA

Ordering data – Individual valve



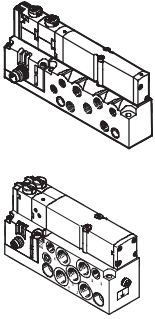







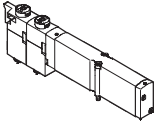
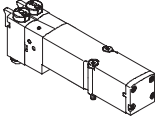

FESTO

Ordering data – Valves on individual sub-base				
	Code	Valve function	Type	Part No.
	Internal pilot air			
	M	5/2-way valve, single solenoid	VMPA1-M1H-M-M7-PI VMPA2-M1H-M-G $\frac{1}{8}$ -PI	533376 537963
	J	5/2-way valve, double solenoid	VMPA1-M1H-J-M7-PI VMPA2-M1H-J-G $\frac{1}{8}$ -PI	533377 537964
	N	2x 3/2-way valve, normally open	VMPA1-M1H-N-M7-PI VMPA2-M1H-N-G $\frac{1}{8}$ -PI	533382 537969
	K	2x 3/2-way valve, normally closed	VMPA1-M1H-K-M7-PI VMPA2-M1H-K-G $\frac{1}{8}$ -PI	533381 537968
	H	2x 3/2-way valve, 1x normally open, 1x normally closed	VMPA1-M1H-H-M7-PI VMPA2-M1H-H-G $\frac{1}{8}$ -PI	533383 537970
	B	5/3-way valve, mid-position pressurised	VMPA1-M1H-B-M7-PI VMPA2-M1H-B-G $\frac{1}{8}$ -PI	533378 537965
	G	5/3-way valve, mid-position closed	VMPA1-M1H-G-M7-PI VMPA2-M1H-G-G $\frac{1}{8}$ -PI	533379 537966
	E	5/3-way valve, mid-position exhausted	VMPA1-M1H-E-M7-PI VMPA2-M1H-E-G $\frac{1}{8}$ -PI	533380 537967
	D	2x 2/2-way valve, normally closed	VMPA1-M1H-D-M7-PI VMPA2-M1H-D-G $\frac{1}{8}$ -PI	533384 537971
	I	2x 2/2-way valve, 1x normally closed, 1 x normally closed, reversible	VMPA1-M1H-I-M7-PI VMPA2-M1H-I-G $\frac{1}{8}$ -PI	545230 545232
	External pilot air			
	MS	5/2-way valve, single solenoid	VMPA1-M1H-M-S-M7-PI VMPA2-M1H-M-S-G $\frac{1}{8}$ -PI	533385 537972
	JS	5/2-way valve, double solenoid	VMPA1-M1H-J-S-M7-PI VMPA2-M1H-J-S-G $\frac{1}{8}$ -PI	533386 537973
	NS	2x 3/2-way valve, normally open	VMPA1-M1H-N-S-M7-PI VMPA2-M1H-N-S-G $\frac{1}{8}$ -PI	533391 537978
	KS	2x 3/2-way valve, normally closed	VMPA1-M1H-K-S-M7-PI VMPA2-M1H-K-S-G $\frac{1}{8}$ -PI	533390 537977
	HS	2x 3/2-way valve, 1x normally open, 1x normally closed	VMPA1-M1H-H-S-M7-PI VMPA2-M1H-H-S-G $\frac{1}{8}$ -PI	533392 537979
	BS	5/3-way valve, mid-position pressurised	VMPA1-M1H-B-S-M7-PI VMPA2-M1H-B-S-G $\frac{1}{8}$ -PI	533387 537974
	GS	5/3-way valve, mid-position closed	VMPA1-M1H-G-S-M7-PI VMPA2-M1H-G-S-G $\frac{1}{8}$ -PI	533388 537975
	ES	5/3-way valve, mid-position exhausted	VMPA1-M1H-E-S-M7-PI VMPA2-M1H-E-S-G $\frac{1}{8}$ -PI	533389 537976
DS	2x 2/2-way valve, normally closed	VMPA1-M1H-D-S-M7-PI VMPA2-M1H-D-S-G $\frac{1}{8}$ -PI	533393 537980	
IS	2x 2/2-way valve, 1x normally closed, 1 x normally closed, reversible	VMPA1-M1H-I-S-M7-PI VMPA2-M1H-I-S-G $\frac{1}{8}$ -PI	545231 545233	

Valve terminals type 32 MPA

Accessories





Ordering data – Individual sub-base valve				
	Code	Valve function	Electrical plug-in connection	
			Type	Part No.
	M	5/2-way valve, single solenoid	VMPA1-M1H-M-PI	533342
			VMPA2-M1H-M-PI	537952
	J	5/2-way valve, double solenoid	VMPA1-M1H-J-PI	533343
			VMPA2-M1H-J-PI	537953
	N	2x 3/2-way valve, normally open	VMPA1-M1H-N-PI	533348
			VMPA2-M1H-N-PI	537958
	NS	2x 3/2-way valve, normally open, mechanical spring return	VMPA1-M1H-NS-PI	556839
	W	1x 3/2-way valve, normally open, external compressed air supply	VMPA1-M1H-W-PI	540050
			VMPA2-M1H-W-PI	540051
	K	2x 3/2-way valve, normally closed	VMPA1-M1H-K-PI	533347
			VMPA2-M1H-K-PI	537957
	KS	2x 3/2-way valve, normally closed, mechanical spring return	VMPA1-M1H-KS-PI	556838
	H	2x 3/2-way valve, 1x normally open, 1x normally closed	VMPA1-M1H-H-PI	533349
			VMPA2-M1H-H-PI	537959
	HS	2x 3/2-way valve, 1x normally open, 1x normally closed, mechanical spring return	VMPA1-M1H-HS-PI	556840
	B	5/3-way valve, mid-position pressurised	VMPA1-M1H-B-PI	533344
			VMPA2-M1H-B-PI	537954
	G	5/3-way valve, mid-position closed	VMPA1-M1H-G-PI	533345
			VMPA2-M1H-G-PI	537955
	E	5/3-way valve, mid-position exhausted	VMPA1-M1H-E-PI	533346
			VMPA2-M1H-E-PI	537956
	X	1x 3/2-way valve, normally closed, external compressed air supply	VMPA1-M1H-X-PI	534415
			VMPA2-M1H-X-PI	537961
	D	2x 2/2-way valve, normally closed	VMPA1-M1H-D-PI	533350
			VMPA2-M1H-D-PI	537960
	DS	2x 2/2-way valve, normally closed, mechanical spring return	VMPA1-M1H-DS-PI	556841
	I	2x 2/2-way valve, 1x normally closed, 1 x normally closed, reversible	VMPA1-M1H-I-PI	543605
			VMPA2-M1H-I-PI	543703

Valve terminals type 32 MPA

Accessories

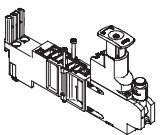
FESTO

Ordering data					
Regulator plate					
	Code	Description	Supply pressure 1 [bar]	Type	Part No.
	PA	MPA2, connection 1	0.5 ... 10	VMPA2-B8-R1C2-C-10	543342
	PC	MPA2, connection 2		VMPA2-B8-R2C2-C-10	543343
	PB	MPA2, connection 4		VMPA2-B8-R3C2-C-10	543344
	PL	MPA2, connection 2, reversible		VMPA2-B8-R6C2-C-10	543347
	PK	MPA2, connection 4, reversible		VMPA2-B8-R7C2-C-10	543348
	PF	MPA2, connection 1	0.5 ... 6	VMPA2-B8-R1C2-C-06	549055
	PH	MPA2, connection 2		VMPA2-B8-R2C2-C-06	549056
	PG	MPA2, connection 4		VMPA2-B8-R3C2-C-06	549057
	PN	MPA2, connection 2, reversible		VMPA2-B8-R6C2-C-06	549113
	PM	MPA2, connection 4, reversible		VMPA2-B8-R7C2-C-06	549114
Pressure gauge for regulator plate					
	-	With cartridge connection for regulator, 10 bar for regulator plate code PA, PB, PC, PL, PK		PAGN-26-16-P10	543487
	-	With cartridge connection for regulator, 6 bar for regulator plate code PF, PG, PH, PN, PM		PAGN-26-10-P10	543488

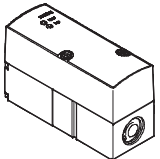
Ordering data – Proportional pressure regulator						
	Code	Full-scale linearity error	Supply pressure 1	Pressure regulation range	Type	Part No.
	QA	2%	0 ... 4 bar	0.02 ... 2 bar	VPPM-6TA-L-1-F-0L2H	542220
	QD	1%			VPPM-6TA-L-1-F-0L2H-S1	542217
	QB	2%	0 ... 8 bar	0.06 ... 6 bar	VPPM-6TA-L-1-F-0L6H	542221
	QE	1%			VPPM-6TA-L-1-F-0L6H-S1	542218
	QC	2%	0 ... 11 bar	0.1 ... 10 bar	VPPM-6TA-L-1-F-0L10H	542222
	QF	1%			VPPM-6TA-L-1-F-0L10H-S1	542219

Valve terminals type 32 MPA

Accessories

FESTO

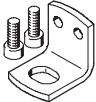
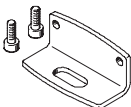
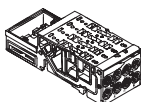
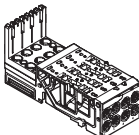
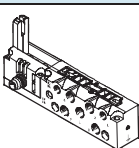
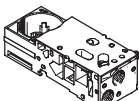
Ordering data					
Designation				Type	Part No.
Mounting					
	For H-rail	MPA with fieldbus		CPX-CPA-BG-NRH	526032
		MPA with multi-pin plug connection		CPA-BG-NRH	173498
	Mounting (for supply plate)			VMPA-BG-RW	534416
	Mounting (for proportional pressure regulator manifold block)			VMPA-BG	558844
Manifold blocks – without electrical manifold module					
	For multi-pin plug/fieldbus	Four valve positions	MPA1	VMPA1-FB-AP-4-1	533352
		Two valve positions	MPA2	VMPA2-FB-AP-2-1	538000
	For multi-pin plug/fieldbus, duct 1 closed	Four valve positions	MPA1	VMPA1-FB-AP-4-1-T1	538657
		Two valve positions	MPA2	VMPA2-FB-AP-2-1-T0	538677
	For multi-pin plug/fieldbus, duct 1 closed and duct 3/5 closed	Four valve positions	MPA1	VMPA1-FB-AP-4-1-S1	555901
		Two valve positions	MPA2	VMPA2-FB-AP-2-1-S0	555902
Manifold blocks – incl. electrical manifold module and electronics module					
	For fieldbus	Four valve positions	MPA1	VMPA1-AP-4-1-EMS-8	546802
		Two valve positions	MPA2	VMPA2-AP-2-1-EMS-4	546803
	For multi-pin plug	Four solenoid coils	MPA1	VMPA1-AP-4-1-EMM-4	546806
		Two solenoid coils	MPA2	VMPA2-AP-2-1-EMM-2	546807
		Eight solenoid coils	MPA1	VMPA1-AP-4-1-EMM-8	546804
		Four solenoid coils	MPA2	VMPA2-AP-2-1-EMM-4	546805
Manifold blocks – for individual connection					
	Without ATEX specification	Internal pilot air	MPA1	VMPA1-IC-AP-1	533394
			MPA2	VMPA2-IC-AP-1	537981
		External pilot air	MPA1	VMPA1-IC-AP-S-1	533395
			MPA2	VMPA2-IC-AP-S-1	537982
	With ATEX specification: II 3 GD EEx nA II T95°C X IP54	Internal pilot air	MPA1	VMPA1-IC-AP-1-EX2	545447
			MPA2	VMPA2-IC-AP-1-EX2	545449
External pilot air		MPA1	VMPA1-IC-AP-S-1-EX2	545448	
		MPA2	VMPA2-IC-AP-S-1-EX2	545450	
Manifold block – for proportional pressure regulator					
	Without electrical manifold module and without electrical module	–	–	VMPA-FB-AP-P1	542223

Valve terminals type 32 MPA

Accessories

FESTO

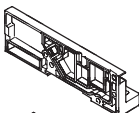
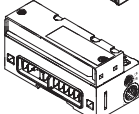
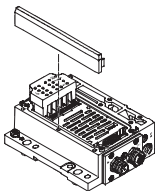
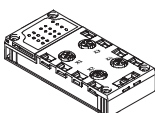
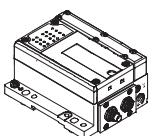
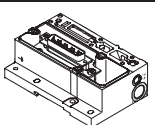
Ordering data					
Designation			Type	Part No.	
End plates and fieldbus pneumatic interface					
 	Right-hand end plate		VMPA-EPR	533373	
	Pneumatic interface, ducted exhaust air, internal pilot air		VMPA-FB-EPL-G	533370	
	Pneumatic interface, ducted exhaust air, internal pilot air, for metal linking CPX		VMPA-FB-EPLM-G	552286	
	Pneumatic interface, ducted exhaust air, external pilot air		VMPA-FB-EPL-E	533369	
	Pneumatic interface, ducted exhaust air, external pilot air, for metal linking CPX		VMPA-FB-EPLM-E	552285	
	Pneumatic interface, flat plate silencer, internal pilot air		VMPA-FB-EPL-GU	533372	
	Pneumatic interface, flat plate silencer, internal pilot air, for metal linking CPX		VMPA-FB-EPLM-GU	552288	
	Pneumatic interface, flat plate silencer, external pilot air		VMPA-FB-EPL-EU	533371	
	Pneumatic interface, flat plate silencer, external pilot air, for metal linking CPX		VMPA-FB-EPLM-EU	552287	
Electrical interface for AS-interface					
	4 inputs/4 outputs	Internal pilot air	Ducted exhaust air	VMPA-ASI-EPL-G-4E4A-Z	546989
			Silencer	VMPA-ASI-EPL-GU-4E4A-Z	546991
		External pilot air	Ducted exhaust air	VMPA-ASI-EPL-E-4E4A-Z	546988
			Silencer	VMPA-ASI-EPL-EU-4E4A-Z	546990
	8 inputs/8 outputs	Internal pilot air	Ducted exhaust air	VMPA-ASI-EPL-G-8E8A-Z	546993
			Silencer	VMPA-ASI-EPL-GU-8E8A-Z	546995
		External pilot air	Ducted exhaust air	VMPA-ASI-EPL-E-8E8A-Z	546992
			Silencer	VMPA-ASI-EPL-EU-8E8A-Z	546994
Manifold block for AS-interface					
	Socket M12, 5-pin		CPX-AB-4-M12x2-5P-M3	546996	
	Socket M8, 3-pin		CPX-AB-8-M8-3P-M3	546998	
	Spring-loaded terminals, 32-pin		CPX-AB-8-KL-4P-M3	546999	
	Socket Sub-D, 25-pin		CPX-AB-1-SUB-BU-25P-M3	547000	
	Socket, quick connection- 4-pin		CPX-AB-4-HAR-4P-M3	547001	
Electrical interface for CPI					
	External pilot air, ducted exhaust air		VMPA-CPI-EPL-E	546983	
	Internal pilot air, ducted exhaust air		VMPA-CPI-EPL-G	546984	
	External pilot air, silencer		VMPA-CPI-EPL-EU	546985	
	Internal pilot air, silencer		VMPA-CPI-EPL-GU	546986	
Electrical interface for multi-pin plug connection					
	External pilot air, ducted exhaust air		VMPA1-MPM-EPL-E	540893	
	Internal pilot air, ducted exhaust air		VMPA1-MPM-EPL-G	540894	
	External pilot air, silencer		VMPA1-MPM-EPL-EU	540895	
	Internal pilot air, silencer		VMPA1-MPM-EPL-GU	540896	

Valve terminals type 32 MPA

Accessories



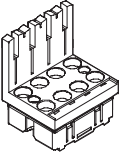
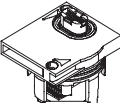
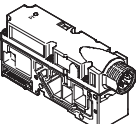
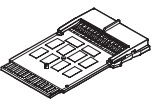
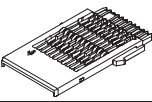

FESTO

Ordering data				
Designation			Type	Part No.
Electronics modules				
	For fieldbus connection, without isolated electrical circuit	4 coils MPA2	VMPA2-FB-EMS-4	537983
	For fieldbus connection, without isolated electrical circuit, with expanded diagnostics function	4 coils MPA2	VMPA2-FB-EMS-D2-4	543332
	For fieldbus connection, without isolated electrical circuit	8 coils MPA1	VMPA1-FB-EMS-8	533360
	For fieldbus connection, without isolated electrical circuit, with expanded diagnostics function	8 coils MPA1	VMPA1-FB-EMS-D2-8	543331
	For fieldbus connection, with isolated electrical circuit	4 coils MPA2	VMPA2-FB-EMG-4	537984
	For fieldbus connection, with isolated electrical circuit, with expanded diagnostics function	4 coils MPA2	VMPA2-FB-EMG-D2-4	543334
	For fieldbus connection, with isolated electrical circuit	8 coils MPA1	VMPA1-FB-EMG-8	533361
	For fieldbus connection, with isolated electrical circuit, with expanded diagnostics function	8 coils MPA1	VMPA1-FB-EMG-D2-8	543333
	For modular multi-pin plug connection (MPM)	2 coils MPA2	VMPA2-MPM-EMM-2	537985
		4 coils MPA2	VMPA2-MPM-EMM-4	537986
4 coils MPA1		VMPA1-MPM-EMM-4	537987	
8 coils MPA1		VMPA1-MPM-EMM-8	537988	
Electrical module				
	For proportional pressure regulator		VMPA-FB-EMG-P1	542224
Electrical supply plate				
	Plug connection M18, 3-pin		VMPA-FB-SP-V	541082
	Plug connection 7/8", 5-pin		VMPA-FB-SP-7/8-V-5POL	541083
	Plug connection 7/8", 4-pin		VMPA-FB-SP-7/8-V-4POL	541084
Electrical manifold module for multi-pin plug connection and AS-interface				
	For a manifold block	2 coils MPA2	VMPA2-MPM-EV-AB-2	537989
		4 coils MPA1, MPA2	VMPA1-MPM-EV-AB-4	537993
		8 coils MPA1	VMPA1-MPM-EV-AB-8	537994
	For a manifold block with pneumatic supply plate	2 coils MPA2	VMPA2-MPM-EV-ABV-2	537991
		4 coils MPA1, MPA2	VMPA1-MPM-EV-ABV-4	537995
		8 coils MPA1	VMPA1-MPM-EV-ABV-8	537996
Electrical manifold module for fieldbus connection and CPI				
	For a manifold block MPA1 and MPA2, for manifold block of the proportional pressure regulator		VMPA1-FB-EV-AB	537998
	For a pneumatic supply plate		VMPA1-FB-EV-V	537999

Valve terminals type 32 MPA

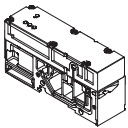
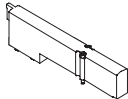
Accessories

FESTO

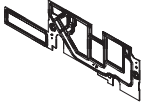
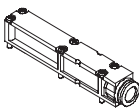
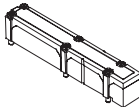
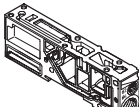





Ordering data				
Designation		Type	Part No.	
Pressure sensor				
	For monitoring the operating pressure in duct 1	VMPA-FB-PS-1	541085	
	For monitoring the pressure in exhaust ducts 3 and 5	VMPA-FB-PS-3/5	541086	
	For monitoring an external process pressure	VMPA-FB-PS-P1	541087	
Cover				
	Blanking plate for vacant valve position ¹⁾	VMPA1-RP	533351	
		VMPA2-RP	537962	
	Cover for manual override, non-detenting (10 pieces)	VMPA1-HBT	533366	
	Cover for manual override, covered (10 pieces)	VMPA1-HBV	535257	
	Cover for manual override, non-detenting (10 pieces)	VMPA-HBT-B	540897	
	Cover for manual override, covered (10 pieces)	VMPA-HBV-B	540898	
Seals for manifold block				
	MPA with ducted exhaust air	No duct separation	VMPA1-DP	533359
		Duct 1 separate	VMPA1-DP-P	533363
		Duct 3/5 separate	VMPA1-DP-RS	533364
		Duct 1 and 3/5 separate	VMPA1-DP-PRS	533365
	MPA with flat plate silencer	No duct separation	VMPA1-DPU	533355
		Duct 1 separate	VMPA1-DPU-P	533356
		Duct 3/5 separate	VMPA1-DPU-RS	533357
		Duct 1 and 3/5 separate	VMPA1-DPU-PRS	533358
Exhaust plate				
	For ducted exhaust air, with 10 mm push-in connector	VMPA-AP	533375	
	For ducted exhaust air, with connection QS-3/8	VMPA-AP-3/8	541629	
	For flat plate silencer	VMPA-APU	533374	
Supply plates (without exhaust plate)				
	For ducted exhaust air	VMPA1-FB-SP	533354	
	For flat plate silencer	VMPA1-FB-SPU	533353	

1) A self-adhesive label is supplied.

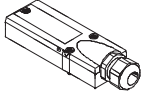
Valve terminals type 32 MPA

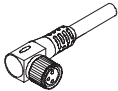
Accessories

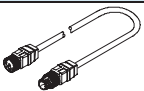
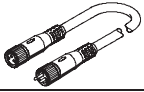







FESTO

Ordering data				
Designation			Type	Part No.
Multi-pin plug connection, electrical				
	Cover without connecting cable for self-assembly		VMPA-KMS-H	533198
	PVC connecting cable for 8 solenoid coils	2.5 m	VMPA-KMS1-8-2,5	533195
		5 m	VMPA-KMS1-8-5	533196
		10 m	VMPA-KMS1-8-10	533197
	PVC connecting cable for 24 solenoid coils	2.5 m	VMPA-KMS1-24-2,5	533192
		5 m	VMPA-KMS1-24-5	533193
		10 m	VMPA-KMS1-24-10	533194
	PUR connecting cable for 8 solenoid coils, suitable for energy chains	2.5 m	VMPA-KMS2-8-2,5-PUR	533504
		5 m	VMPA-KMS2-8-5-PUR	533505
		10 m	VMPA-KMS2-8-10-PUR	533506
	PUR connecting cable for 24 solenoid coils, suitable for energy chains	2.5 m	VMPA-KMS2-24-2,5-PUR	533501
		5 m	VMPA-KMS2-24-5-PUR	533502
		10 m	VMPA-KMS2-24-10-PUR	533503
	Connecting cable, individual connection			
	Plug socket with cable, straight socket	2.5 m	SIM-M8-4GD-2,5-PU	158960
		5 m	SIM-M8-4GD-5-PU	158961
	Plug socket with cable, angled socket	2.5 m	SIM-M8-4WD-2,5-PU	158962
		5 m	SIM-M8-4WD-5-PU	158963
	Connecting cable, straight socket	2.5 m	NEBU-M8G4-K-2.5-LE4	541342
		5 m	NEBU-M8G4-K-5-LE4	541343
	Connecting cable, angled socket	2.5 m	NEBU-M8W4-K-2.5-LE4	541344
		5 m	NEBU-M8W4-K-5-LE4	541345
Connecting cable, AS-interface connection				
	Connecting cable, straight plug-straight socket	M12, 4-pin/5-pin, 0.2 m	NEBU-M12G5-F-0.2-M12G4	542129
	Modular system for connecting cables		→ Internet: nebu	-
Connecting cable, CPI connection				
	Connecting cable WS-WD, angled plug-angled socket	0.25 m	KVI-CP-3-WS-WD-0,25	540327
		0.5 m	KVI-CP-3-WS-WD-0,5	540328
		2 m	KVI-CP-3-WS-WD-2	540329
		5 m	KVI-CP-3-WS-WD-5	540330
		8 m	KVI-CP-3-WS-WD-8	540331
	Connecting cable GS-GD, straight plug-straight socket	2 m	KVI-CP-3-GS-GD-2	540332
		5 m	KVI-CP-3-GS-GD-5	540333
		8 m	KVI-CP-3-GS-GD-8	540334

Valve terminals type 32 MPA

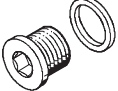
Accessories

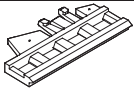
FESTO

Ordering data				
Designation			Type	Part No.
Push-in fitting for manifold block, pneumatic interface, supply plate				
	Connecting thread M5 for tubing O.D.	3 mm (10 pieces)	QSM-M5-3-I	153313
		4 mm (10 pieces)	QSM-M5-4-I	153315
		6 mm (10 pieces)	QSM-M5-6-I	153317
	Connecting thread M7 for tubing O.D.	4 mm (10 pieces)	QSM-M7-4-I	153319
		6 mm (10 pieces)	QSM-M7-6-I	153321
	Connecting thread G $\frac{1}{8}$ for tubing O.D.	6 mm (10 pieces)	QS-G $\frac{1}{8}$ -6-I	186107
		8 mm (10 pieces)	QS-G $\frac{1}{8}$ -8-I	186109
	Connecting thread G $\frac{1}{4}$ for tubing O.D.	8 mm (10 pieces)	QS-G $\frac{1}{4}$ -8-I	186110
		10 mm (10 pieces)	QS-G $\frac{1}{4}$ -10-I	186112
	Silencer			
	Connecting thread	M5	UC-M5	165003
		M7	UC-M7	161418
		G $\frac{1}{4}$	UC- $\frac{1}{4}$	165004
		G $\frac{1}{8}$	UC- $\frac{1}{8}$	161419
	Push-in sleeve connection	3 mm	UC-QS-3H	165005
		4 mm	UC-QS-4H	165006
		6 mm	UC-QS-6H	165007
		8 mm	UC-QS-8H	175611
		10 mm	UC-QS-10H	526475
Blanking plug				
	Thread M5		B-M5	3843
	Thread M7		B-M7	174309
	Thread G $\frac{1}{8}$		B- $\frac{1}{8}$	3568
	Thread G $\frac{1}{4}$		B- $\frac{1}{4}$	3569
Plug				
	Blanking plug for tubing O.D.	4 mm	QSC-4H	153267
		6 mm	QSC-6H	153268
		8 mm	QSC-8H	153269
		10 mm	QSC-10H	153270
Inscription labels				
	Inscription label holder for manifold block, transparent, for paper foil label		VMPA1-ST-1-4	533362
	Inscription label holder for manifold block, 4-fold, for IBS-6x10		VMPA1-ST-2-4	544384
	Inscription labels 6 x 10 in frame, 64 pieces		IBS-6x10	18576

Valve terminals type 32 MPA

Accessories

FESTO

Ordering data				
Designation		Type	Part No.	
Manual				
	MPA Pneumatic	German	P.BE-MPA-DE	534240
		English	P.BE-MPA-EN	534241
		French	P.BE-MPA-FR	534243
		Spanish	P.BE-MPA-ES	534242
		Italian	P.BE-MPA-IT	534244
		Swedish	P.BE-MPA-SV	534245
	MPA electronic description (Pneumatic modules, pressure sensor, proportional pressure regulators, etc.)	German	P.BE-MPA-Elektronik-DE	562112
		English	P.BE-MPA-Elektronik-EN	562113
		French	P.BE-MPA-Elektronik-FR	562115
		Spanish	P.BE-MPA-Elektronik-ES	562114
		Italian	P.BE-MPA-Elektronik-IT	562116
		Swedish	P.BE-MPA-Elektronik-SV	562117

What must be observed when using Festo components?

Specified limit values for technical data and any specific instructions must be adhered to by the user in order to ensure recommended operating conditions.

When pneumatic components are used, the user shall ensure that they are operated using correctly prepared compressed air without aggressive media.

When Festo components are used in safety-oriented applications, the user shall ensure that all applicable

national and local safety laws and regulations, for example the machine directive, together with the relevant references to standards are observed. Unauthorised conversions or modifications to products and systems from Festo involve a safety risk and are thus not permissible.

Festo does not accept any liability for resulting damages.

You should contact Festo's advisors if one of the following apply to your application:

- The ambient conditions and conditions of use or the operating medium differ from the specified technical data.
- The product is to perform a safety function.
- A risk or safety analysis is required.
- You are unsure about the product's suitability for use in the planned application.
- You are unsure about the product's suitability for use in safety-oriented applications.

All technical data applies at the time of going to print.

All texts, representations, illustrations and drawings included in this catalogue are the intellectual property of Festo AG & Co. KG, and are protected by copyright law.

All rights reserved, including translation rights. No part of this publication may be reproduced or transmitted in any form or by any means, electronic, mechanical, photocopying or otherwise, without the prior written permission of Festo AG & Co. KG. All technical data subject to change according to technical update.