

Description

Compact actuator to control or regulate valves.
Brushless motor technology.
With a preset working angle of 90°.
Connection according to ISO5211/DIN3337.

Equipped in standard with:

- Emergency override with handwheel
- 2 additional volt free end switches
- Electronic torque limiter
- Automatic interior heater
- Coloured status LED
- Dome position indicator
- Freely adjustable cams (max. 340°)
- Standard 2 point control, 3 point regulation

Technical data

Voltage range: 24-240V DC/AC (50/60 Hz)

Current consumption: 0,16 A - 1,28 A

Working time/90°: 09 s ± 10%

Heater: 3,5 W

Break torque: 25 Nm

Operation torque: 20 Nm

Duty rating [ED]: 75%

Protection class: IP67

Temperature range: -20°C - +70°C

Flange: F03/F04/F05 - F07 via Kit

Stem intake: ⌀ 9 mm, 11 mm, 14 mm (Standard)
□ 11x16,5 mm

Plugs: EN175301-803 Form A
Industrial connector form C (9,4mm)

Housing material: Polyamid (PA6)

Endswitches: SPST NO 5A 125V AC / 3A 250V AC

Weight: 1,8 kg



Options

BSR (Battery safety pack)

In case of a power failure, the actuator turns to a predefined safety position (open or close).

Variations: NC, NO
-Combination with: DPS, 3 Positions, Potentiometer, Permanent phase-

DPS (Digital positioning system)

The position of the actuator is controlled by an input signal and provides its actual position as an output signal.

Following signal types are available:
0-10V, 1-10V, 0-20mA, 4-20mA

3 Positions

The actuator has the possibility to drive to a middle position.

Standard: 0°-90°-180°

Permanent phase wiring

The actuator has a permanent power connection and automatically turns to the predetermined position. When the other contact is powered, the actuator turns to the opposite direction.

Variations: NC, NO

Potentiometer

A Potentiometer inside of the actuator gives out its actual position as an ohmic value.

Variations: 1kΩ, 5kΩ, 10kΩ

B-Series (12V version)

The actuator is controlled by a voltage of 12V AC/DC.

-Combination with all options possible-

Bluetooth

A Bluetooth module gives the possibility to control and read out via Bluetooth.

Modbus

A Modbus module gives the possibility to control and read out the actuator via Modbus.

Technical drawing

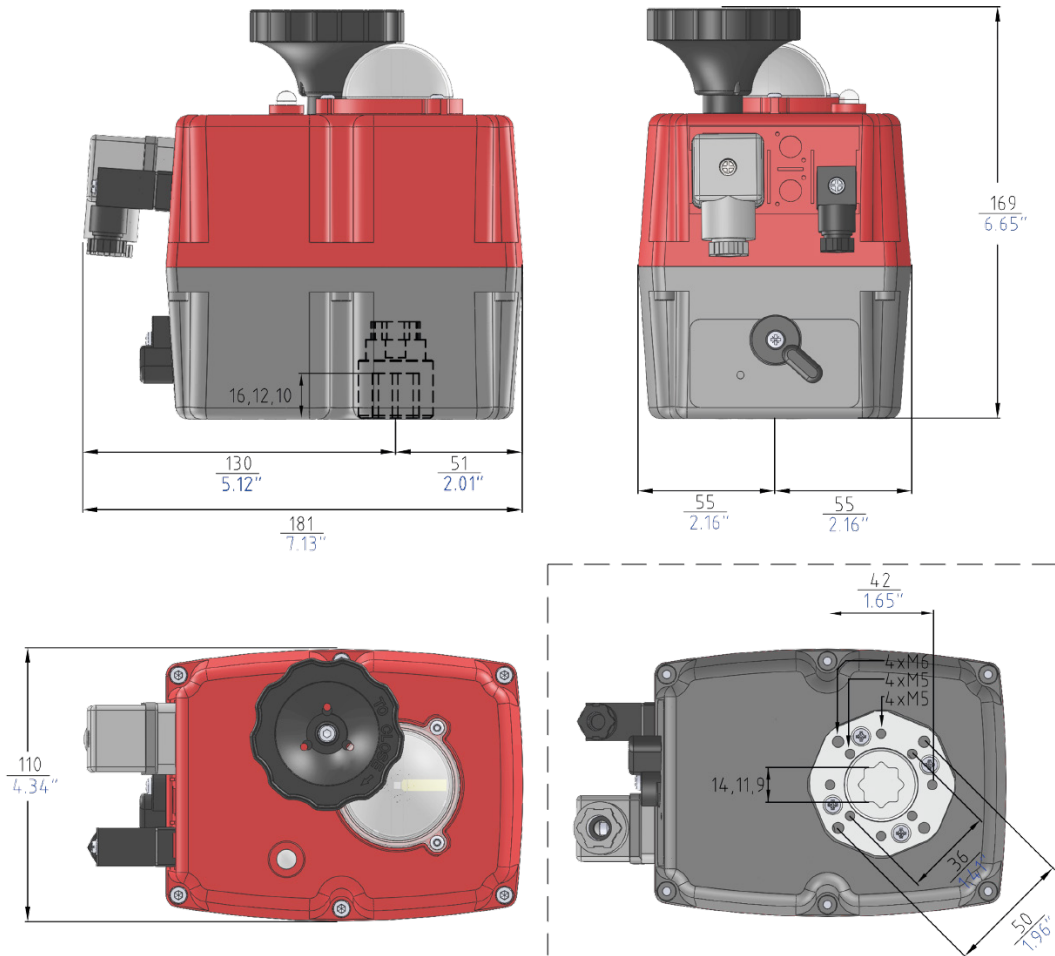

Wiring diagram

Versorgungsstecker supply plug

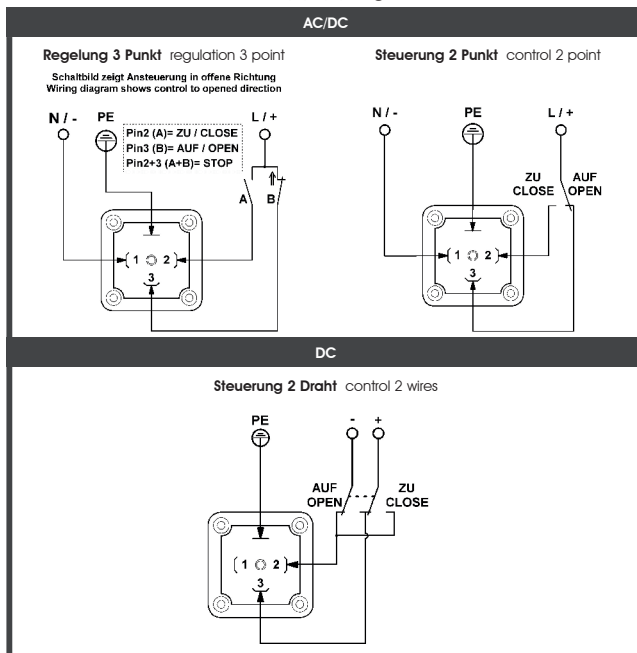

Endlagenstecker end position plug

