

# RVS Push-in koppelingen EBSTX

*Push-in koppelingen geheel uit RVS 1.4401*

*Slangmontage met één hand*

*Voor slangen van verschillende materialen*

*Klein formaat en licht gewicht*

*FKM O-ring voor hoge temperaturen*

*Modulair flexibel ontwerp*

EBSTX

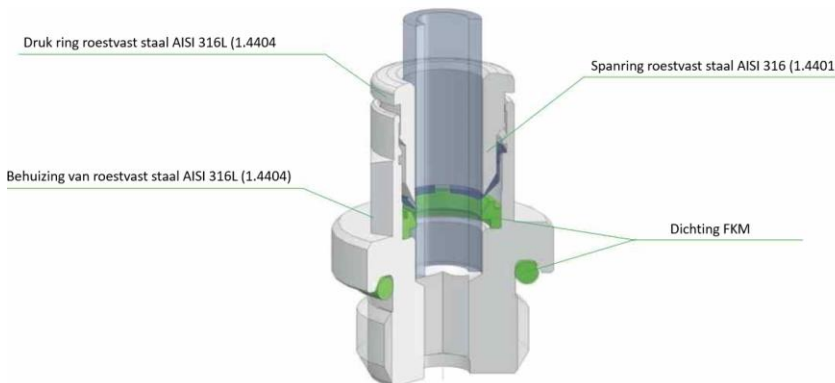

Werktemperatuur: -20 ° C tot + 150 ° C

Werkdruk: 16 bar (let op het drukbereik van de slang)

Vacuüm: max 98%

Materialen:

- Behuizing van roestvast staal AISI 316L (1.4404)
- Dichting FKM
- Spanring roestvast staal AISI 316 (1.4401)
- Druk ring roestvast staal AISI 316L (1.4404)

Draad:

- Cilindrisch DIN EN ISO 228 (cilindrisch met O-ring afdichting)
- Conisch DIN EN 10226 (DIN 2999)
- Metrisch DIN ISO 261

Medium: gesmeerde en niet-gesmeerde media die compatibel zijn met de materialen van de componenten

Slangen:

voor slangen volgens ISO 14743

Toleranties voor externe  $\varnothing$ 4-8:  $\pm 0,1$

Toleranties voor externe  $\varnothing$

10-14:  $\pm 0,15$  (PU)

10-14:  $\pm 0,1$  (PA)

### EBSTX 01k Rechte inschroefkoppeling conisch

Art#	Type	ØD	R	ØB	H	L	ISW	SW
10006216	EBSTX 01k 4-1/8	4	R1/8	9	6,5	19	3	10
10006215	EBSTX 01k 4-1/4	4	R1/4	9	11	22,5	3	14
10006218	EBSTX 01k 6-1/8	6	R1/8	11	7,5	21,5	5	12
10006217	EBSTX 01k 6-1/4	6	R1/4	11	11	21,5	5	14
10006220	EBSTX 01k 8-1/8	8	R1/8	13	7,5	26,5	6	14
10006219	EBSTX 01k 8-1/4	8	R1/4	13	11	23,5	6	14
10006211	EBSTX 01k 10-1/4	10	R1/4	15	11	30,5	8	16
10006212	EBSTX 01k 10-3/8	10	R3/8	15	11,5	26,5	8	17
10006214	EBSTX 01k 12-3/8	12	R3/8	17	11,5	27,5	10	17
10006213	EBSTX 01k 12-1/2	12	R1/2	17	14	27,5	10	22

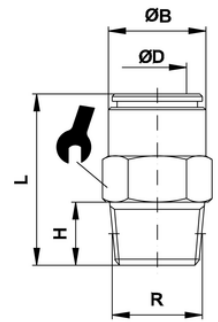

### EBSTX 01 Rechte inschroefkoppeling cilindrisch met O-ring afdichting

Art#	Type	ØD	R	ØB	H	L	ISW	SW
10006222	EBSTX 01 4-M5	4	M5	9	4	20,5	-	9
10006221	EBSTX 01 4-1/8	4	G1/8	9	5,5	19	3	13
10114123	EBSTX 01 6-M5	6	M5	11	4	22,5	2,5	-
10006224	EBSTX 01 6-1/8	6	G1/8	11	5,5	23,5	4	13
10006223	EBSTX 01 6-1/4	6	G1/4	11	6,5	20	4	16
10006226	EBSTX 01 8-1/8	8	G1/8	13	5,5	26	5	13
10006225	EBSTX 01 8-1/4	8	G1/4	13	6,5	23	6	16
10114124	EBSTX 01 10-1/4	10	G1/4	15	6,5	27,5	7	16
10114125	EBSTX 01 10-3/8	10	G3/8	15	9	25,5	8	20
10114126	EBSTX 01 10-1/2	10	G1/2	15	9	29	8	23
10114127	EBSTX 01 12-1/4	12	G1/4	17	6,5	30	7	18
10114128	EBSTX 01 12-3/8	12	G3/8	17	9	31	10	20
10114129	EBSTX 01 12-1/2	12	G1/2	17	9	29	10	23

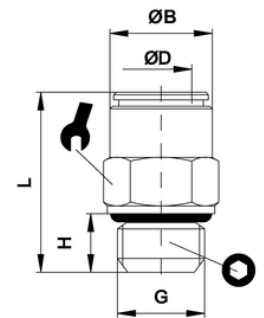

### EBSTX 03 Rechte doorverbind koppeling push-in

Art#	Type	ØD	ØB	L
10006265	EBSTX 03 4	4	9	32
10006266	EBSTX 03 6	6	11	35
10006267	EBSTX 03 8	8	13	39
10006263	EBSTX 03 10	10	15	39
10006264	EBSTX 03 12	12	17	41

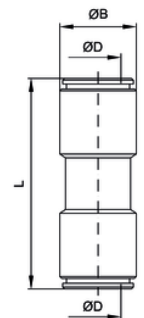

### EBSTX 04 Haakse doorverbind koppeling push-in

Art#	Type	ØD	ØB	L	SW
10006275	EBSTX 04 4	4	9	17,5	9
10006276	EBSTX 04 6	6	11	20,5	11
10006277	EBSTX 04 8	8	13	22,5	11
10006273	EBSTX 04 10	10	15	25	15
10006274	EBSTX 04 12	12	17	27	15

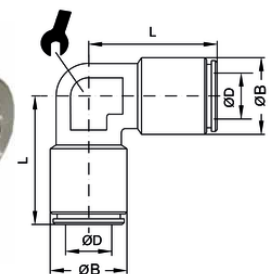

### EBSTX 05 T-koppeling push-in

Art#	Type	ØD	ØB	L1	L2	SW
10006280	EBSTX 05 4	4	9	18	36	9
10006281	EBSTX 05 6	6	11	20,5	41	11
10006282	EBSTX 05 8	8	13	22,5	45	11
10006278	EBSTX 05 10	10	15	25	50	15
10006279	EBSTX 05 12	12	17	26,5	53	15

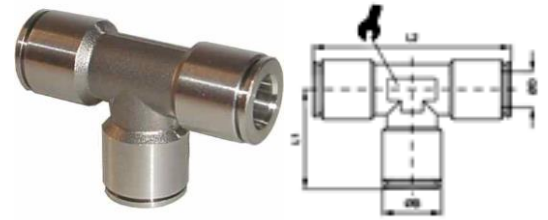

### EBSTX 019 Haakse inschroefkoppeling conisch - push-in

Art#	Type	ØD	R	ØB	H	L1	L2	SW
10006227	EBSTX 019 4-1/8	4	R1/8	9	7,5	14	18,5	9
10006229	EBSTX 019 6-1/8	6	R1/8	11	8	17	20,5	11
10006228	EBSTX 019 6-1/4	6	R1/4	11	11,5	20	20,5	11
10006231	EBSTX 019 8-1/8	8	R1/8	13	8	17	22,5	11
10006230	EBSTX 019 8-1/4	8	R1/4	13	11	20	22,5	11

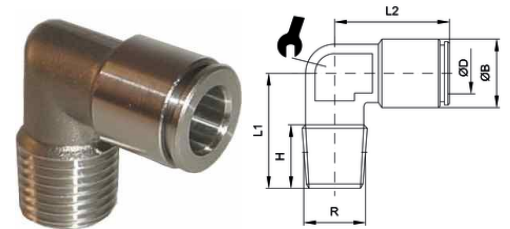

### EBSTX 022k Haakse inschroefkoppeling draaibaar conisch - push-in

Art#	Type	ØD	R	ØB	H	L1	L2	SW2	SW1
10006236	EBSTX 22k 4-1/8	4	R1/8	9	7	20	20	13	10
10114130	EBSTX 22k 4-1/4	4	R1/4	9	11	25	20	10	14
10006238	EBSTX 22k 6-1/8	6	R1/8	11	7	20	21,5	13	10
10006237	EBSTX 22k 6-1/4	6	R1/4	11	11	25	21,5	14	10
10006240	EBSTX 22k 8-1/8	8	R1/8	13	7	20	23,5	13	10
10006239	EBSTX 22k 8-1/4	8	R1/4	13	11	25	23,5	14	10
10006232	EBSTX 22k 10-1/4	10	R1/4	15	11	26	26,5	16	15
10006233	EBSTX 22k 10-3/8	10	R3/8	15	11	30	26,5	15	17
10006235	EBSTX 22k 12-3/8	12	R3/8	17	11	32,5	28,5	17	20
10114131	EBSTX 22k 12-1/4	12	R1/4	17	11	32,5	28,5	17	20
10006234	EBSTX 22k 12-1/2	12	R1/2	17	14	35,5	28,5	17	22

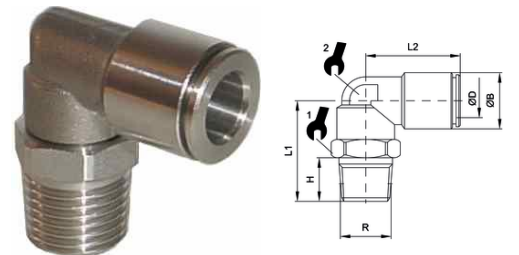

### EBSTX 022 Haakse inschroefkoppeling draaibaar cilindrisch - push-in

Art#	Type	ØD	G	ØB	H	L1	L2	SW1	SW2
10006242	EBSTX 22 4-M5	4	M5	9	4	15	18	9	9
10006241	EBSTX 22 4-1/8	4	G1/8	9	5,5	19,5	20	13	10
10114132	EBSTX 22 4-1/4	4	G1/4	9	6,5	20,5	20	16	10
10114133	EBSTX 22 6-M5	6	M5	11	4	14,5	20,5	9	9
10006244	EBSTX 22 6-1/8	6	G1/8	11	5,5	19,5	21,5	13	10
10006243	EBSTX 22 6-1/4	6	G1/4	11	6,5	20,5	21,5	16	10
10006246	EBSTX 22 8-1/8	8	G1/8	13	5,5	19,5	23,5	13	10
10006245	EBSTX 22 8-1/4	8	G1/4	13	6,5	20,5	23,5	16	10
10114134	EBSTX 22 10-1/4	10	G1/4	15	6,5	23	26,5	16	15
10114135	EBSTX 22 10-3/8	10	G3/8	15	9	26,5	26,5	20	15
10114136	EBSTX 22 12-3/8	12	G3/8	17	9	28,5	28,5	20	17
10114137	EBSTX 22 12-1/2	12	G1/2	18,5	8,5	33,5	28	20	-

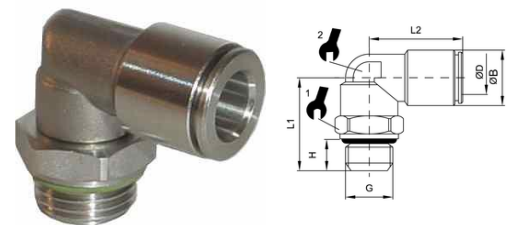

### EBSTX 020k T-inschroefkoppeling conisch draaibaar - push-in

Art#	Type	ØD	R	ØB	H	L1	L2	SW1	SW2
10006249	EBSTX 020k 4-1/8	4	R1/8	9	7,5	21,5	35	10	-
10006251	EBSTX 020k 6-1/8	6	R1/8	11	7	25,5	43	13	11
10006250	EBSTX 020k 6-1/4	6	R1/4	11	11	30,5	43	14	11
10006253	EBSTX 020k 8-1/8	8	R1/8	13	7	26	47	13	11
10006252	EBSTX 020k 8-1/4	8	R1/4	13	11	30,5	47	14	11
10006247	EBSTX 020k 10-1/4	10	R1/4	15	11	32	51	16	15
10006248	EBSTX 020k 10-3/8	10	R3/8	15	11	30,5	51	17	15

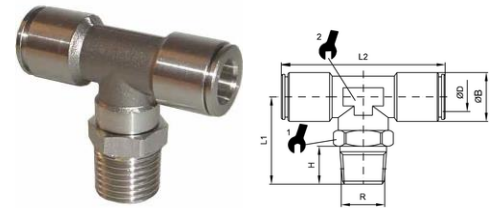

### EBSTX 020 Haakse inschroefkoppeling cilindrisch draaibaar - push-in

Art#	Type	ØD	G	ØB	H	L1	L2	SW1	SW2
10006255	EBSTX 020 4-M5	4	M5	9	4	20,5	36	9	9
10006254	EBSTX 020 4-1/8	4	G1/8	9	5,5	25,5	36	13	11
10006257	EBSTX 020 6-1/8	6	G1/8	11	5,5	25	43	13	11
10006256	EBSTX 020 6-1/4	6	G1/4	11	6,5	26	43	16	11
10006259	EBSTX 020 8-1/8	8	G1/8	13	5,5	25	47	13	11
10006258	EBSTX 020 8-1/4	8	G1/4	13	6,5	26	47	16	11
10114138	EBSTX 020 10-1/4	10	G1/4	15	6,5	23,5	51	16	15
10114139	EBSTX 020 10-3/8	10	G3/8	15	9	27	51	20	15

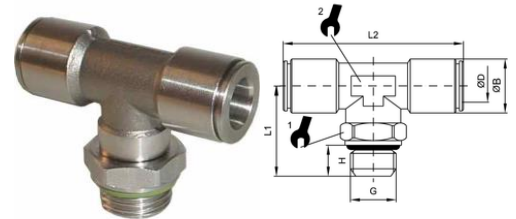

### EBSTX 08 Rechte push-in koppeling, verkleiner

Art#	Type	ØD1	ØD2	ØB	L
10006260	EBSTX 08 4-6	4	6	9	30,5
10006261	EBSTX 08 6-8	6	8	11	33
10006262	EBSTX 08 8-10	8	10	13	38,5



### EBSTX 010 Schotdoorvoerkoppeling push-in

Art#	Type	ØD	ØB	M	L1	L2 MAX	SW
10006270	EBSTX 010 4 M12x1	4	9	M12x1	32	11	15
10006271	EBSTX 010 6 M14x1	6	11	M14x1	34	16	17
10006272	EBSTX 010 8 M16x1	8	13	M16x1	37	17	19
10006268	EBSTX 010 10 M18x1	10	15	M18x1	39,5	21	21
10006269	EBSTX 010 12 M20x1	12	17	M20x1	41	20	24

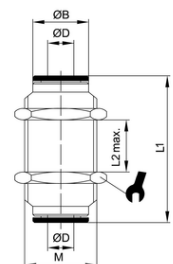

### EBSTX 013 Haakse Banjo koppeling push-in

Art#	Type	ØD	G	ØB	H	L
10006285	EBSTX 013 4 1/8	4	G1/8	14	15	20,5
10006287	EBSTX 013 6 1/8	6	G1/8	14	15	22,5
10006286	EBSTX 013 6 1/4	6	G1/4	18	17	24
10006289	EBSTX 013 8 1/8	8	G1/8	14	15	23
10006288	EBSTX 013 8 1/4	8	G1/4	18	17	25,5

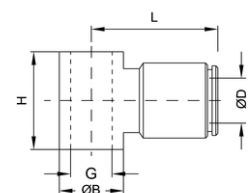

### EBSTX 028 Snelheidsregelventiel Type A, Toevoerlucht regelbaar (kleppen)

Art#	Type	ØD	G	H	L1 MAX	L2	SW
10006290	EBSTX 028 4-1/8	4	G1/8	7	32	21	14
10006292	EBSTX 028 6-1/8	6	G1/8	7	32	22,5	14
10006291	EBSTX 028 6-1/4	6	G1/4	8	40	24,5	17
10006294	EBSTX 028 8-1/8	8	G1/8	7	32	24	14
10006293	EBSTX 028 8-1/4	8	G1/4	8	40	26	17

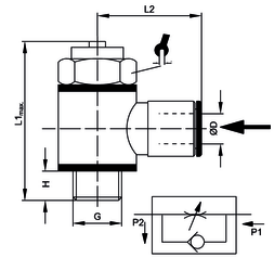

### EBSTX 029 Snelheidsregelventiel Type B, Afgaande lucht regelbaar (cilinders)

Art#	Type	ØD	G	H	L1 MAX	L2	SW
10006295	EBSTX 029 4-1/8 B	4	G1/8	7	32	21	14
10006297	EBSTX 029 6-1/8 B	6	G1/8	7	32	22,5	14
10006296	EBSTX 029 6-1/4 B	6	G1/4	8	40	24,5	17
10006299	EBSTX 029 8-1/8 B	8	G1/8	7	32	24	14
10006298	EBSTX 029 8-1/4 B	8	G1/4	8	40	26	17

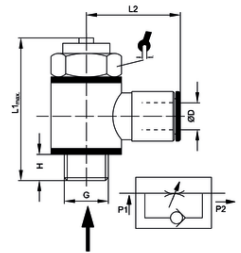

### EBSTX 407 Holle banjo bout met 2 teflon dichtingen

Art#	Type	G	H1	H2	L	SW
10006284	EBSTX 407 1/8	G1/8	9,5	15,5	29	14
10006283	EBSTX 407 1/4	G1/4	9	17,5	32,5	17

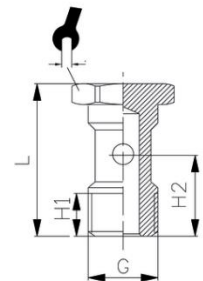

### Teflon luchtslang PTFE "Anaconda"

Teflon luchtslang (PTFE) metrisch, buitenmaats gekalibreerd voor push-in koppelingen  
 Hoge chemische resistentie (inert) en te gebruiken in een zeer groot temperatuurbereik.  
 Temperatuurbereik -200 °C tot +250 °C, hittebestendig !  
 PTFE slang brand en rookt niet, geen aanhechting, lage mechanisch sterkte  
 UV, ozon en zuurstof-bestendig (verouderd niet)

Teflon slang wordt vaak afgeraden in combinatie per teflon slang omdat teflon kruipt. Wij hebben echter de ervaring dat deze slang goed geschikt is voor de push-in koppelingen (mits de slang buitenmaats gekalibreerd is) in de toepassingen als pneumatiek slang.

Deze slang is leverbaar in: Melkwit, rood, blauw, geel en zwart