

- **Function of pump control (Low-high level control), individual measuring conductive probe**
- **Dual channel, two single relay output**
- **Continuous sensitivity adjustment and time delay set up**
- **Optical state indication**
- **Wall mounted case or DIN rail 35mm mounted**



Level control relay CDSU are dual channel units designed to evaluate the states of the conductive probes. They include power supply 5 V AC for supplying the probes. The DIP switches enable to select a basic mode (an independent function of two limit sensors) or the level control mode between the maximum and minimum level (pump control). The level control relay allows continuous sensitivity adjustment and time delay set up by trimmer.

FEATURES OF VARIANTS

CDSU-522 **DIN rail mounting**, continuous sensitivity adjustment, fixed output delay time.

CDSU-522-W **Wall mounted case**, possible outdoor installation (protection class IP65), continuous sensitivity adjustment and time delay set up.

TECHNICAL SPECIFICATIONS			CDSU-522	CDSU-522-W
Nominal supply voltage			230 V AC / 50 Hz (± 10 %)	230 V AC / 50 Hz (± 10 %)
Nominal power demand			4 VA	4 VA
Output voltage to supply probes			5 V AC / 70 Hz	5 V AC / 70 Hz
Output short circuit current			0.2 mA	0.2 mA
Max. duration of output short-circuit			Unlimited	Unlimited
No. of connecting probes			1 or 2 (+ common)	1 or 2 (+ common)
No. of switching channels			2	2
Input currents			0 ... 0.2 mA *	0 ... 0.2 mA *
Range of continuous sensitivity			10 ... 250 kΩ	10 ... 250 kΩ
Output delay			1 s	0.5 ... 10 s
Contact rating	Max. load current		2 A	2 A
	Max. switching voltage		250 V	250 V
	Max. switching power		500 VA	500 VA
Max. switching frequency at maximum load			360 / h	360 / h
Contact life at maximum load			Min. 10 ⁶ cycles	Min. 10 ⁶ cycles
Ambient temperature range			-20 ... +50°C	-20 ... +50°C
Maximum / recommended conductor size			4 mm ² / 0.5 ... 1 mm ²	2.5 mm ² / 0.14 ... 0.5 mm ²
Protection class			IP20	IP65
Weight			Approx. 0.2 kg	Approx. 0.35 kg

* by adjusted sensitivity

DIMENSIONAL DRAWING

CDSU-522

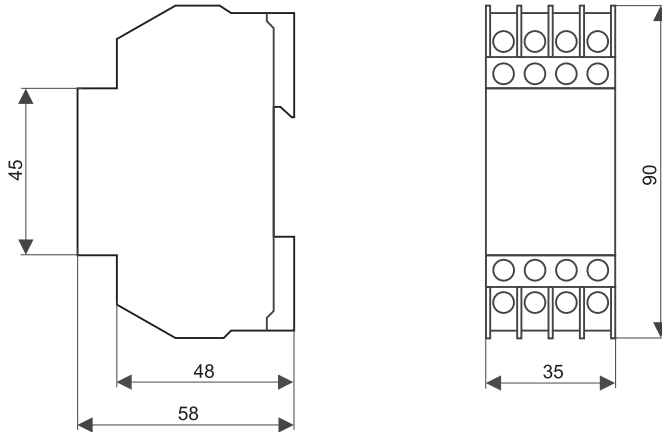

CDSU-522-W

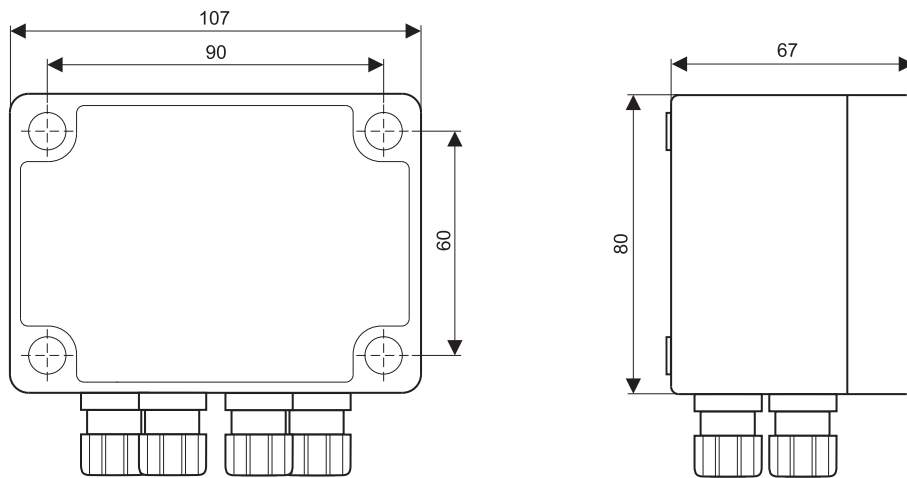

FRONT PANEL AND TERMINAL BLOCK

CDSU-522

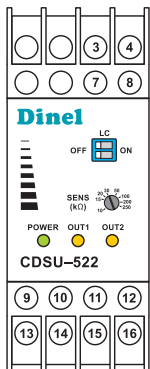

CDSU-522-W

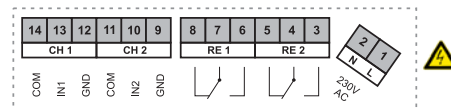
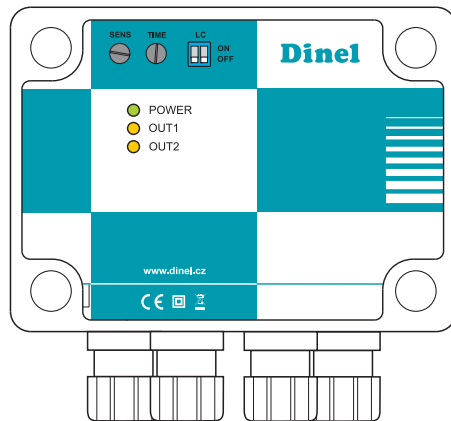

Terminal	CDSU-522	CDSU-522-W
1		
2		
3	IN1	RE2
4	IN2	RE2
5		RE2
6		RE1
7	COM	RE1
8	COM	RE1
9	L (230 V)	
10	RE2	IN2
11	RE2	COM
12	RE2	
13	N (230 V)	IN1
14	RE1	COM
15	RE1	
16	RE1	

Note: Due to the safety protection, both relay outputs (RE 1 and RE 2) must be connected to the same voltage level (such as 230 V and 230 V or 24 V and 24 V).

INNER BLOCK DIAGRAMS

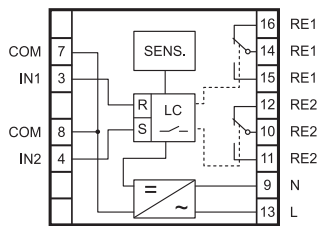

CDSU-522

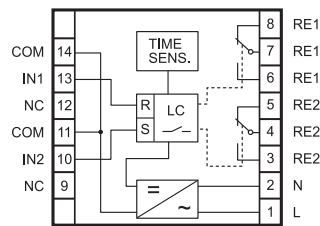

CDSU-522-W

Legend:

- COM** – Common conductive probe
- IN1** – Measuring conductive probe No. 1
- IN2** – Measuring conductive probe No. 2
- RE1** – Relay No.1 contacts
- RE2** – Relay No.2 contacts
- L, N** – Supply voltage input (230 V AC)
- NC** – Not connected

Note: The relays are released in inner block diagrams.

OPERATING ELEMENTS

- **Switch “LC”** – *position OFF:* Activation of the basic mode
– *position ON:* Activation of the pump control mode
- **Trimmer “SENS”:** Setting the sensitivity (10 to 250 kΩ)
- **Trimmer “TIME” (CDSU-522-W):** Setting the output delay (0.5 to 10 s). Level control relay aren't responding on short-term level changes, which are smaller than present (setted) value.

FUNCTION DESCRIPTION

Basic mode – “LC” switch in OFF position

- Activation the probe connected to IN 1 input causes closing the output relay RE 1 terminals 14; 15 (CDSU-522) or 7; 6 (CDSU-522-W) are closed and shining LED indicator “OUT 1”.
- Activation the probe connected to IN2 input causes closing the output relay RE 2 terminals 4; 3 (CDSU-522) or 10, 11 (CDSU-522-W) are closed and shining LED indicator “OUT 2”.

Pump-up function – “LC” switch in ON position

- When the level drops below the probe connected to IN 1 (MIN) input, the output relay RE 1 terminals 14; 15 (CDSU-522) or 7; 6 (CDSU-522-W) are closed. LED indicator “OUT 1” start shining. This starts the active device (pump, valve, etc.) and the level goes up. When the level reaches the position of the probe connected to IN 2 (MAX) input, the output relay RE 1 terminals 14; 15 (CDSU-522) or 7; 6 (CDSU-522-W) are open. This stops the active device and the level goes down. LED indicator “OUT 1” darkens.

Pump-down function – “LC” switch in ON position

- When the level drops below the probe connected to IN 2 (MAX) input, the output relay RE 1 terminals terminals 14; 16 (CDSU-522) or 7; 8 (CDSU-522-W) are closed. LED indicator “OUT 1” darkens. This starts the active device (pump, valve, etc.) and the level goes down. When the level reaches the position of the probe connected to IN 1 (MIN) input, the output relay RE 1 terminals 14; 16 (CDSU-522) or 7; 8 (CDSU-522-W) are open. This stops the active device and the level goes up. LED indicator “OUT 1” start shining.

STATUS SIGNALIZATION

LED indicators	Colour	Function
“POWER”	Green	Shines – Device connected to supply voltage, correct function Dark – Power loss or internal failure
“OUT 1”	Orange	Shines – The output relay RE 1 is closed Dark – The output relay RE 1 is open
“OUT 2”	Orange	Shines – The output relay RE 2 is closed Dark – The output relay RE 2 is open

WIRING EXAMPLES

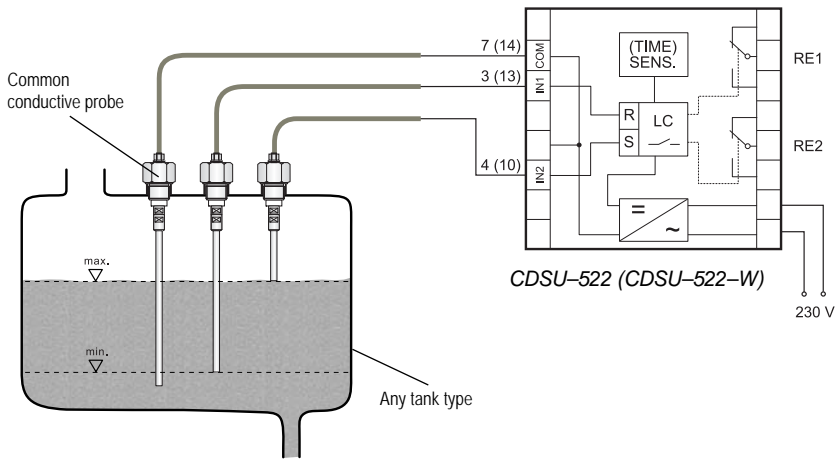

Level control relay CDSU for connection to three conductive probes (CNP-18-30) in **any** tank type.

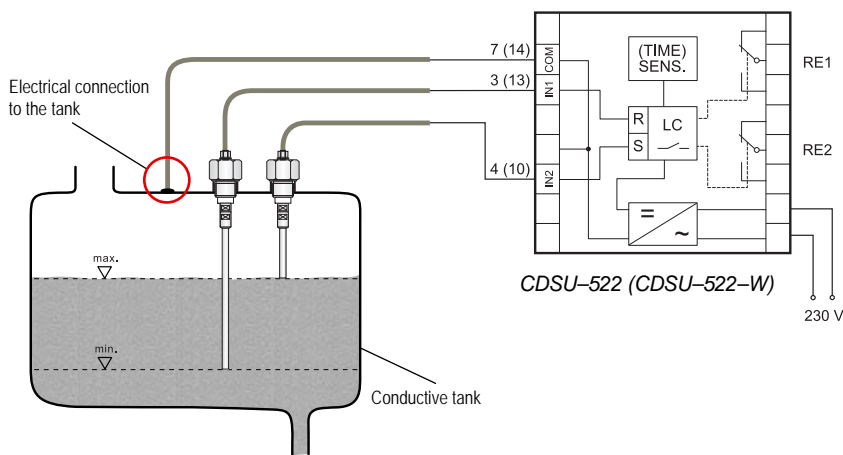

Level control relay CDSU for connection to two conductive probes (CNP-18-30) in **conductive** tank type.

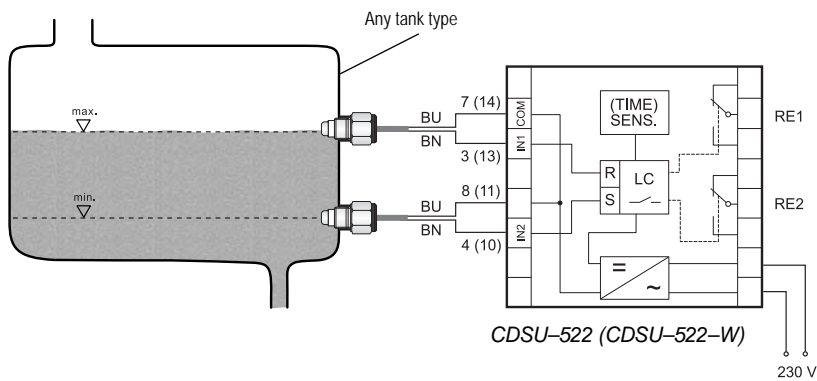

Level control relay CDSU for connection to two conductive probes (CNP-18-10) in **any** tank type.

Legend:

BN – Brown
BU – Blue

Note: The relays are released in inner block diagrams.

SAFETY, PROTECTION AND COMPATIBILITY

Level control relays are equipped with protection against current overload. Units are sheltered by fuse T 50 mA. Electrical equipment of protection group II. Electrical safety according to EN 61010-1.

Electromagnetic compatibility according to EN 55022, EN 61000-4-2, -3, -4, -5, -6, -11 and EN 61000-6-2.

Version 11/2012