

# FPD470 Wedge flowmeter

## Differential pressure – primary flow element

Robust, reliable, high performance flow solutions for difficult applications, slurries and high viscosity liquid

Measurement made easy



### Symmetrical robust element for long-term accuracy

- no sharp edge to wear
- handles slurries and high solids content
- capable of bi-directional flow

### Accurate performance down to Reynolds number 500

- 0.5 % calibrated accuracy
- large potential flow range
- ideally suited to measurement of viscous liquids

### Minimum upstream / downstream straight pipe needed

- handles non-ideal installations

# FPD470 Wedge flowmeter

## Differential pressure – primary flow element

### Overview

WEDGE™ flow elements utilize V-shaped restrictions to produce a square root relationship between differential pressure and volumetric flow. Elements are designed for either clean or dirty service and are offered in various materials, pipe sizes, and pressure ratings. The differential pressure is measured by a differential pressure transmitter. Various process connections on the WEDGE are provided for either pneumatic or electronic transmitters or other differential pressure sensing devices. Wedge meters can be flow calibrated and supplied with a factory calibration report, this includes calculations for the user's process when such data is supplied. The differential pressure measurement is used to calculate flow using a standard wedge flow equation.

The flow element consists of a body and wedge flow restriction. This restriction creates a differential pressure in proportion to the square of the volumetric flow rate. The wedge restriction has no critical surface dimensions, or sharp edges, to affect measurement accuracy as the result of normally expected wear.

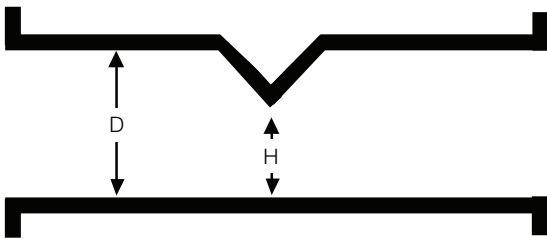

Fig. 1: Primary flow element – restriction schematic

### Primary flow element types

#### Flanged transmitter connections (model FPD470F)



#### Chemical-tee transmitter connections (model FPD470C)



#### Pipe-tap transmitter connections (model FPD470P)

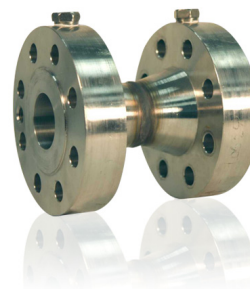

## Performance specification

### Transmitter connections

Connection to the transmitter can be selectable from a range.

#### FPD470F

2 or 3 in. RF flange (SCH 80 I.D.)

#### FPD470C

Chemical-tee type – 8-hole mounting pattern

#### FPD470P

1/2, 3/8, 1/4 in. NPT

### WEDGE element standard H/D ratios – see Fig. 1, page 2

This H/D ratio equals the height of the opening under restriction divided by the internal pipe diameter:

0.2, 0.3, 0.4, 0.5, 0.6, 0.7 (restrictions per model code)

Pipe size (in.)	Wedge ratio (H/D)	Accuracy in % of flow rate	
		Calibrated	Un-calibrated
1/2	0.2, 0.3, 0.4, 0.5	0.75 %	+5 %
1 and 1 1/2	0.2, 0.3, 0.4, 0.5	0.5 %	+5 %
2 and 3	0.2, 0.3, 0.4, 0.5	0.5 %	+5 %
4 to 20	0.3, 0.4, 0.5, 0.6, 0.7	0.5 %	+5 %

\*Water calibrated in factory flow lab –

refer to calibration report supplied with each calibrated instrument

Table 1: H/D ratios

To determine H/D ratio and differential pressure, refer to SolveDp sizing software.

### Process flange connection

- ANSI Class 150 raised face
- ANSI Class 300 raised face
- ANSI Class 600 raised face

(contact ABB for additional end flange ratings)

### Process end connection

ABB offers a wide range of process end connections including ANSI and DIN flanges.

### Internal bore

A range of schedules and wall thicknesses are available to suit specific requirements, these should be selected to ensure the meter is suitable for the design temperature and pressure. The most typical schedule for a WEDGE is schedule 80.

### Flange style

- Standard weight pipe is the same as Schedule 40 on 100 to 250 mm (4 to 10 in.) size
  - Standard weight wall is 9.5 mm (0.375 in.) on 300 to 600 mm (12 to 24 in.) pipe size
  - Standard weight not available on 3 in. and smaller
  - X-Strong wall pipe is the same as Schedule 80 on 15 to 200 mm (0.5 to 8 in.) size
  - X-Strong wall is 12.7 mm (0.5 in.) on 250 to 600 mm (10 to 24 in.) pipe size
- (contact ABB for information on additional pipe schedules)

# FPD470 Wedge flowmeter

## Differential pressure – primary flow element

### Materials of construction

#### Process wetted parts

Standard materials of construction are carbon steels and 316 SST but ABB is able to offer over 30 different materials. Below are examples of a few different available materials:

- 25 % Cr Super Duplex (UNS S32750)
- C276 Alloy (UNS N010276)
- 347H stainless steel

#### Welding

Pressure retaining welds are completed following the Section IX code and also meet the PED specifications. World-renowned suppliers are used to ensure quality and assurance of welding processes and welding consumable certificates show the mechanical capabilities as well as full traceability of each batch.

### Chemical-tee gasket material

#### Supplied with FPD470C chemical-tee version

Up to 340 °C (645 °F) graphite.

Sealability per ASTM F37A (1/32) 0.50 ml/hr (part no.155S1043 for 2 gasket kit)

### Pressure Equipment Directive (PED)

Wedgemeters can fall under the pressure equipment directive, if this option is selected ABB will perform the calculations per PED Module H and if it falls under the CATII or CATIII classification will create a technical file to facilitate the request.

## Physical specification

### Accuracy

#### Calibrated

25 mm (1 in.) or larger:  $\pm 0.5$  % of actual flow when operated within the calibrated range  
15 mm ( $1/2$  in.):  $\pm 0.75$  % of actual flow when operated within the calibrated range

#### Un-calibrated

$\pm 5.0$  % of actual flow when using nominal  $K_d^2$  from sizing program. Applies to bi-directional flow

#### Bi-directional

Same as above when  $K_d^2$  designated as reverse flow coefficient

### Repeatability

$\pm 0.2$  %

### Temperature and pressure rating

The temperature and pressure rating is dependent on line schedule, materials of construction and process or tapping connection rating.

#### Chemical-tee instrument connection

FPD470C chemical-tee is 300 psi max. or the end flange rating per ANSI B16.5, whichever is lower

#### Flanged instrument connection

MWP is per ANSI B16.5

#### Pipe-tap connection

MWP is per ANSI B16.5

## Dimensions and weights

Series FPD470F with flanged tapings and RFWN end flanges  
 Sizes 40, 50 and 80 mm (1½, 2 and 3 in.)

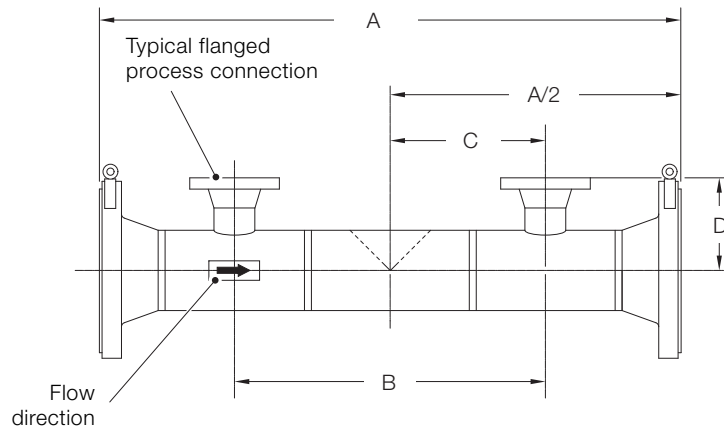

Pipe size mm (in.)	A ±4.58 mm (±0.18 in.)			B	C	D mm (in.)			Approximate weight kg (lbs.)		
	Flange rating					Flange rating			Flange rating		
	150	300	600			150	300	600	150	300	600
40 (1½)	530 (20.86)	543 (21.37)	559 (22)	292 (11.5)	146 (5.75)	207 (8.18)	214 (8.43)	212 (8.37)	25 (55)	28 (61)	32 (71)
50 (2)	546 (21.5)	559 (22)	577 (22.75)	292 (11.5)	146 (5.75)	216 (8.5)	222 (8.75)	231 (9.12)	28 (62)	32 (70)	38 (84)
80 (3)	645 (24.5)	641 (25.25)	660 (26)	311 (12.25)	155 (6.13)	155 (6.13)	166 (6.56)	175 (6.88)	35 (78)	42 (92)	46 (102)

# FPD470 Wedge flowmeter

## Differential pressure – primary flow element

Sizes 100 to 600 mm (4 to 24 in.)

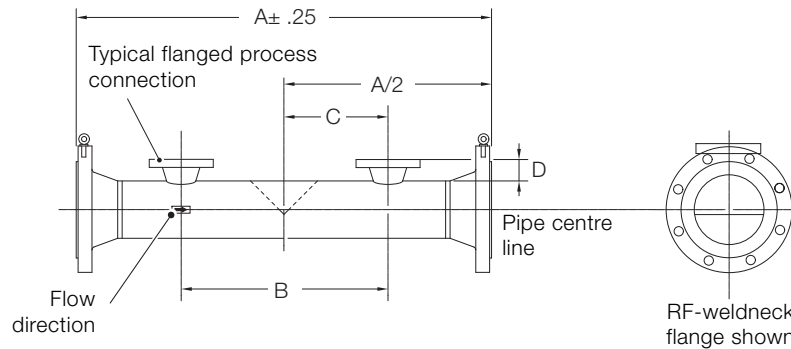

Pipe size mm (in.)	A ±6.35 mm (±0.25 in.)			B	C	D max (ref) mm (in.)			Approximate weight kg (lbs.)		
	Flange rating					Flange rating			Flange rating		
	150	300	600			150	300	600	150	300	600
100 (4)	901 (35.5)	920 (36.25)	990 (39)	381 (15)	190 (7.5)	70 (2.75)	79 (3.12)	89 (3.5)	61 (135)	68 (150)	79 (175)
150 (6)	1028 (40.5)	1047 (41.25)	1098 (43.25)	457 (18)	228 (9)	70 (2.75)	79 (3.12)	89 (3.5)	73 (160)	95 (210)	122 (270)
200 (8)	1092 (43)	1111 (43.75)	1168 (46)	521 (20.5)	260 (10.25)	70 (2.75)	79 (3.12)	89 (3.5)	95 (210)	120 (265)	166 (365)
250 (10)	1143 (45)	1174 (46.25)	1257 (49.5)	597 (23.5)	298 (11.75)	70 (2.75)	79 (3.12)	89 (3.5)	122 (270)	156 (345)	238 (525)
300 (12)	1321 (52)	1352 (53.25)	1416 (55.75)	673 (26.5)	336 (13.25)	70 (2.75)	79 (3.12)	89 (3.5)	159 (350)	181 (400)	
350 (14)	1397 (55)	1428 (56.25)	1485 (58.5)	736 (29)	356 (14)	70 (2.75)	79 (3.12)	89 (3.5)	186 (410)	277 (610)	
400 (16)	1473 (58)	1511 (59.5)	1587 (62.5)	775 (30.5)	387 (15.25)	70 (2.75)	79 (3.12)	89 (3.5)	227 (500)	342 (755)	
450 (18)	1574 (62)	1613 (63.5)	1676 (66.00)	851 (33.5)	413 (16.75)	70 (2.75)	79 (3.12)	89 (3.5)	227 (500)	395 (870)	
500 (20)	1686 (66.37)	1720 (67.75)	1790 (70.5)	940 (37)	470 (18.5)	70 (2.75)	79 (3.12)	89 (3.5)	318 (700)	499 (1100)	
600 (24)	1854 (73)	1886 (74.25)	1968 (77.5)	1066 (42)	533 (21)	70 (2.75)	79 (3.12)	89 (3.5)	433 (955)	594 (1310)	

Series FPD470C with chemical-tee tappings and RFSO end flanges  
 Sizes 15 to 80 mm (½ to 3 in.)

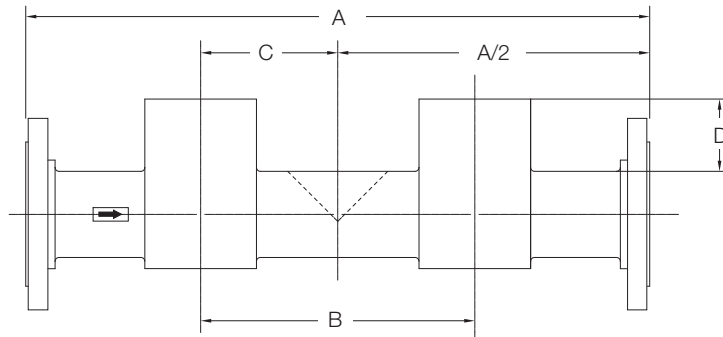

Pipe size mm (in.)	A ±3.3 mm (±0.13 in.)	B mm (in.)	C mm (in.)	D mm (In.)	Approximate weight kg (lbs.)		
					Flange rating		
					150	300	600
15 (½)	457 (18)	165 (6.5)	82.5 (3.25)	25 (1)	10 (23)	10 (23)	10 (23)
25 (1)	482 (19)	179 (7.06)	90 (3.53)	38 (1.5)	11.8 (26)	13 (29)	13.6 (30)
40 (1½)	508 (20)	203 (8)	101 (4)	47 (1.86)	19.5 (43)	22 (49)	23 (51)
50 (2)	533 (21)	213 (8.38)	106 (4.19)	57 (2.25)	23 (51)	25 (55)	27 (59)
80 (3)	609 (24)	263 (10.35)	131 (5.19)	70 (2.75)	31 (69)	36 (79)	38 (84)

# FPD470 Wedge flowmeter

## Differential pressure – primary flow element

Series FPD470C with chemical-tee tappings and RFWN end flanges  
 Sizes 100 to 600 mm (4 to 24 in.)

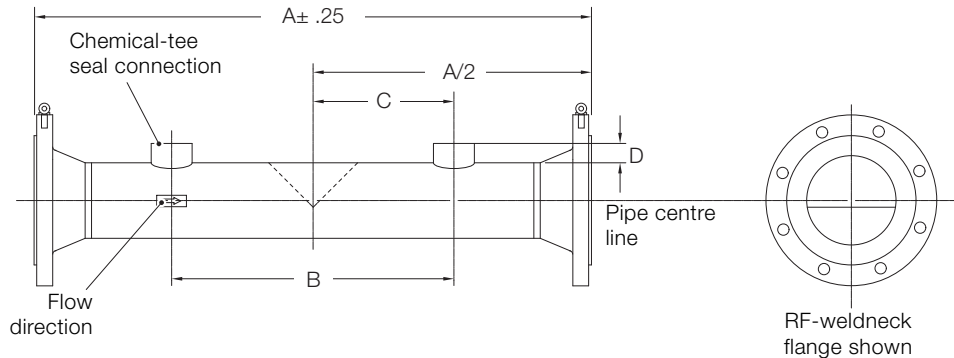

Pipe size mm (in.)	A ±6.35 mm (±0.25 in.)			B mm (in.)	C mm (in.)	D mm (in.)	Approximate weight kg (lbs.)		
	Flange rating						Flange rating		
	150	300	600				150	300	600
100 (4)	901 (35.5)	920 (36.25)	965 (38)	381 (15)	190 (7.5)	24 (0.94)	29 (65)	34 (75)	50 (110)
150 (6)	1028 (40.5)	1047 (41.25)	1098 (43.25)	457 (18)	228 (9)	24 (0.94)	41 (90)	59 (130)	88 (195)
200 (8)	1092 (43)	1111 (43.75)	1168 (46)	521 (20.5)	260 (10.25)	24 (0.94)	52 (115)	79 (175)	129 (285)
250 (10)	1143 (45)	1174 (46.25)	1257 (49.5)	597 (23.5)	298 (11.75)	24 (0.94)	75 (165)	127 (280)	204 (450)
300 (12)	1321 (52)	1352 (53.25)	1416 (55.75)	673 (26.5)	336 (13.25)	24 (0.94)	106 (235)	172 (380)	
350 (14)	1397 (55)	1428 (56.25)	1485 (58.5)	711 (28)	356 (14)	24 (0.94)	140 (310)	283 (625)	
400 (16)	1473 (58)	1511 (59.5)	1587 (62.5)	775 (30.5)	387 (15.25)	24 (0.94)	186 (410)	290 (640)	
450 (18)	1574 (62)	1613 (63.5)	1676 (66.00)	851 (33.5)	413 (16.75)	24 (0.94)	227 (500)	367 (810)	
500 (20)	1686 (66.37)	1720 (67.75)	1790 (70.5)	940 (37)	470 (18.5)	24 (0.94)	286 (630)	456 (1005)	
600 (24)	1854 (73)	1886 (74.25)	1968 (77.5)	1066 (42)	533 (21)	24 (0.94)	395 (870)	539 (1190)	



**Series FPD470P with RFWN end flanges**  
**Sizes 50 to 150 mm (2 to 6 in.)**

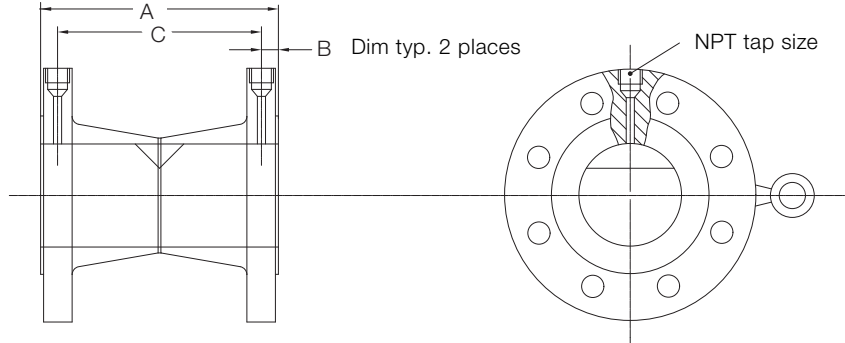

Pipe size mm (in.)	A mm (in.)			B mm (in.)			C mm (in.)			NPT tap size (in.)			Approximate weight kg (lbs.)		
	Flange rating			Flange rating			Flange rating			Flange rating			Flange rating		
	150	300	600	150	300	600	150	300	600	150	300	600	150	300	600
50 (2)	127 (5.00)	171 (6.75)	171 (6.75)	11 (0.44)	24 (0.94)	24 (0.94)	105 (4.13)	124 (4.87)	124 (4.87)	1/4	1/2	1/2	6.3 (14)	12.2 (27)	16 (36)
75 (3)	140 (5.50)	178 (7.00)	178 (7.00)	13 (0.52)	24 (0.94)	24 (0.94)	112 (4.44)	130 (5.12)	130 (5.12)	3/8	1/2	1/2	11 (25)	10.4 (23)	23.5 (52)
100 (4)	190 (7.50)	222 (8.75)	254 (10.00)	12.7 (0.50)	24 (0.94)	24 (0.94)	165 (6.50)	174 (6.87)	206 (8.12)	3/8	1/2	1/2	16 (35)	24 (66)	34 (76)
150 (6)	254 (10.00)	276 (10.87)	323 (12.75)	14 (0.56)	24 (0.94)	24 (0.94)	223 (8.80)	228 (9.00)	174 (6.87)	3/8	1/2	1/2	24.5 (54)	48 (106)	50 (110)

# FPD470 Wedge flowmeter

## Differential pressure – primary flow element

Sizes 200 to 600 mm (8 to 24 in.)

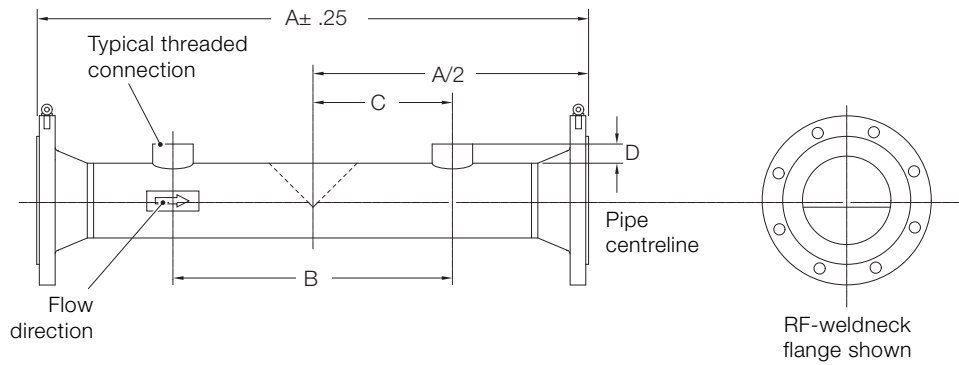

Pipe size mm (in.)	A $\pm 6.35$ mm ( $\pm 0.25$ in.)			B mm (in.)	C mm (in.)	D mm (in.)	Approximate weight kg (lbs.)		
	Flange rating						Flange rating		
	150	300	600				150	300	600
200 (8)	1092 (43)	1111 (43.75)	1168 (46)	520 (20.5)	260 (10.25)	24 (0.94)	52 (115)	79 (175)	129 (285)
250 (10)	1143 (45)	1174 (46.25)	1257 (49.5)	597 (23.5)	298 (11.75)	24 (0.94)	75 (165)	127 (280)	204 (450)
300 (12)	1320 (52)	1352 (53.25)	1416 (55.75)	673 (26.5)	336 (13.25)	24 (0.94)	107 (235)	172 (380)	
350 (14)	1397 (55)	1428 (56.25)	1485 (58.5)	711 (28)	356 (14)	24 (0.94)	140 (310)	283 (625)	
400 (16)	1473 (58)	1511 (59.5)	1587 (62.5)	775 (30.5)	387 (15.25)	24 (0.94)	186 (410)	290 (640)	
450 (18)	1575 (62)	1612 (63.5)	1676 (66)	851 (33.5)	425 (16.75)	24 (0.94)	226 (500)	367 (810)	
500 (20)	1676 (66.37)	1720 (67.75)	1790 (70.5)	940 (37)	470 (18.5)	24 (0.94)	286 (630)	455 (1005)	
600 (24)	1854 (73)	1886 (74.25)	1968 (77.5)	1066 (42)	533 (21)	24 (0.94)	394 (870)	539 (1190)	

## Ordering information

WEDGE flowmeter	FPD470	X	XX	XXX	XX	XX	XX	XX	XX	XX	XX	XX	XX	XX	XXX	XXX	XX	XXX	XX	XXX	XX	XXX
<b>Product design</b>																						
Pipe-tap		P																				
Flanged taps		F																				
Chemical tee taps		C																				
<b>Restriction design</b>																						
Single wedge			W1																			
<b>Line nominal bore</b>																						
DN 15 (1/2 in.)				015																		
DN 20 (3/4 in.)				020																		
DN 25 (1 in.)				025																		
DN 32 (1 1/4 in.)				032																		
DN 40 (1 1/2 in.)				040																		
DN 50 (2 in.)				050																		
DN 65 (2 1/2 in.)				065																		
DN 80 (3 in.)				080																		
DN 90 (3 1/2 in.)				090																		
DN 100 (4 in.)				100																		
DN 125 (5 in.)				125																		
DN 150 (6 in.)				150																		
DN 200 (8 in.)				200																		
DN 250 (10 in.)				250																		
DN 300 (12 in.)				300																		
DN 350 (14 in.)				350																		
DN 400 (16 in.)				400																		
DN 450 (18 in.)				450																		
DN 500 (20 in.)				500																		
DN 550 (22 in.)				550																		
DN 600 (24 in.)				600																		
DN 650 (26 in.)				650																		
DN 700 (28 in.)				700																		
DN 750 (30 in.)				750																		
DN 800 (32 in.)				800																		
DN 850 (34 in.)				850																		
DN 900 (36 in.)				900																		
DN 950 (38 in.)				950																		
DN 1000 (40 in.)				001																		
DN 1050 (42 in.)				051																		
DN 1100 (44 in.)				101																		
DN 1150 (46 in.)				151																		
DN 1200 (48 in.)				201																		
Others				999																		

Continued on next page...

# FPD470 Wedge flowmeter

## Differential pressure – primary flow element

WEDGE flowmeter	FPD470	X	XX	XXX	XX	XX	XX	XX	XX	XX	XX	XX	XX	XXX	XXX	XX	XXX	XX	XXX	XXX	XX	XXX
See page 11																						
<b>Pipe schedule</b>																						
Schedule 5S					S1																	
Schedule 5					S2																	
Schedule 10S					S3																	
Schedule 10					S4																	
Schedule 20					S5																	
Schedule 30					S6																	
Schedule 40S					S7																	
Schedule 40					S8																	
Schedule STD					S9																	
Schedule 60					T1																	
Schedule 80S					T2																	
Schedule 80					T3																	
Schedule XS					T4																	
Schedule 100					T5																	
Schedule 120					T6																	
Schedule 140					T7																	
Schedule 160					T8																	
Schedule XXS					T9																	
Others					Z9																	

Continued on next page...

WEDGE flowmeter

FPD470

X	XX	XXX	XX	XX	XX	XX	XX	XX	XX	XX	XX	XX	XXX	XXX	XX	XXX	XX	XXX	XXX	XX	XXX
See pages 11				12																	

Pipe material

Carbon steel	C3
316 / 316L stainless steel	S6
304 / 304L stainless steel	S4
316H stainless steel	H6
304H stainless steel	H4
Low temperature carbon steel	C4
High yield carbon steel (Gr 52)	C5
High yield carbon steel (Gr 65)	C6
High yield carbon steel (Gr 60)	C7
310 stainless steel	S3
321 stainless steel	S2
321H stainless steel	S1
347 stainless steel	S5
347H stainless steel	S7
317 / 317L stainless steel	S8
904L stainless steel	S9
22 % Cr Duplex (UNS S31803)	D1
25 % Cr Super Duplex (UNS S32750)	D2
25 % Cr Super Duplex (UNS S32760)	D3
6 % Mo SS (UNS S31254)	M1
Alloy 20 (UNS N08020)	U1
Alloy 200 (UNS N02200)	U2
Alloy 400 (UNS N04400)	M4
Alloy 600 (UNS N06600)	U3
Alloy 625 (UNS N06625)	N2
Alloy 800 (UNS N08800)	U4
Alloy 825 (UNS N08825)	U5
Alloy C-22 (UNS N06022)	U6
Alloy C-276 (UNS N010276)	U7
5Cr-1/2Mo low alloy F5 (UNS K41545)	F3
9Cr-1Mo-V low alloy F91 (UNS K91560)	F7
1 1/4Cr-1/2Mo low alloy F11 (UNS K11597)	F4
2 1/4Cr-1Mo low alloy F22 (UNS K21590)	F5
90/10 CuNi (UNS C70600)	P2
Titanium grade 2	T2
Titanium grade 5	T5
Tantalum	L1
Others	Z9

Continued on next page...

# FPD470 Wedge flowmeter

## Differential pressure – primary flow element

WEDGE flowmeter	FPD470	X	XX	XXX	XX	XX	XX	XX	XX	XX	XX	XX	XX	XXX	XXX	XX	XXX	XX	XXX	XXX	XX	XXX		
		See pages 11			12	13																		
<b>Restriction material</b>																								
316 / 316L stainless steel																							S6	
Carbon steel																								C3
316 / 316L stainless steel																								S6
304 / 304L stainless steel																								S4
316H stainless steel																								H6
304H stainless steel																								H4
Low temperature carbon steel																								C4
High yield carbon steel (Gr 52)																								C5
High yield carbon steel (Gr 65)																								C6
High yield carbon steel (Gr 60)																								C7
310 stainless steel																								S3
321 stainless steel																								S2
321H stainless steel																								S1
347 stainless steel																								S5
347H stainless steel																								S7
317 / 317L stainless steel																								S8
904L stainless steel																								S9
22 % Cr Duplex (UNS S31803)																								D1
25 % Cr Super Duplex (UNS S32750)																								D2
25 % Cr Super Duplex (UNS S32760)																								D3
6 % Mo SS (UNS S31254)																								M1
Alloy 20 (UNS N08020)																								U1
Alloy 200 (UNS N02200)																								U2
Alloy 400 (UNS N04400)																								M4
Alloy 600 (UNS N06600)																								U3
Alloy 625 (UNS N06625)																								N2
Alloy 800 (UNS N08800)																								U4
Alloy 825 (UNS N08825)																								U5
Alloy C-22 (UNS N06022)																								U6
Alloy C-276 (UNS N010276)																								U7
5Cr-1/2Mo low alloy F5 (UNS K41545)																								F3
9Cr-1Mo-V low alloy F91 (UNS K91560)																								F7
1 1/4Cr-1/2Mo low alloy F11 (UNS K11597)																								F4
2 1/4Cr-1Mo low alloy F22 (UNS K21590)																								F5
90/10 CuNi (UNS C70600)																								P2
Titanium grade 2																								T2
Titanium grade 5																								T5
Tantalum																								L1
Others																								Z9

Continued on next page...

WEDGE flowmeter

FPD470

X	XX	XXX	XX	XX	XX	XX	XX	XX	XX	XX	XX	XX	XXX	XXX	XX	XXX	XX	XXX	XXX	XX	XXX	
See pages 11					12	13	14															

H/D ratio

0.2	H2
0.3	H3
0.4	H4
0.5	H5
0.6	H6
0.7	H7
Others	Z9

Process connection type

Weld prepared ends	P1
Raised face socket weld flange	S1
Full face socket weld flange	S2
Raised face threaded flange	T3
Full face threaded flange	T4
Raised face weld neck end flange	R2
Raised face slip-on flange	R3
Oval RTJ weld neck end flange	J2
Octagonal RTJ weld neck end flange	J4
Flat face weld neck end flange	F2
Flat face slip-on flange	F3
DIN tongue and groove flange	D1
Hub joint	H1
Compact flange	C1
Lap joint flange	L1
Wafer	W1
Threaded BSPT	T1
Threaded NPT	T2
Others	Z9

Continued on next page...

# FPD470 Wedge flowmeter

## Differential pressure – primary flow element

WEDGE flowmeter	FPD470	X	XX	XXX	XX	XX	XX	XX	XX	XX	XX	XX	XX	XXX	XXX	XX	XXX	XX	XXX	XX	XXX
	See pages 11	12	13	14	15																
<b>Process connection rating</b>																					
ASME Class 150																					
ASME Class 300																					
ASME Class 600																					
ASME Class 900																					
ASME Class 1500																					
ASME Class 2500																					
DIN PN 6																					
DIN PN 10																					
DIN PN 16																					
DIN PN 25																					
DIN PN 40																					
DIN PN 63																					
DIN PN 100																					
ISO 7005 PN 6 EN 1092-1																					
ISO 7005 PN 10 EN 1092-1																					
ISO 7005 PN 16 EN 1092-1																					
ISO 7005 PN 25 EN 1092-1																					
ISO 7005 PN 40 EN 1092-1																					
Flanges JIS 7.5K																					
Flanges JIS 10K																					
Flanges JIS 5K																					
Flanges JIS 20K																					
Flanges JIS 30K																					
Tri-Clamp acc. DIN 32676																					
Tri-Clamp acc. ISO 2852																					
Tri-Clamp acc. ASME BPE																					
BS10 TABLE A																					
BS10 TABLE D																					
BS10 TABLE E																					
BS10 TABLE H																					
API 2000 PSI TYPE 6BX																					
API 3000 PSI TYPE 6BX																					
API 5000 PSI TYPE 6BX																					
API 10000 PSI TYPE 6BX																					
API 15000 PSI TYPE 6BX																					
API 20000 PSI TYPE 6BX																					
Others																					

Continued on next page...



**WEDGE flowmeter**

**FPD470**

X	XX	XXX	XX	XX	XX	XX	XX	XX	XX	XX	XX
See pages 11			12	13	14	15		16			

**Tapping type**

Pipe nipple (butt weld or male tapping)	N1
Nipolet (butt weld or male tapping)	N2
Nipoflange RF	N3
Nipoflange RTJ	N4
Nipoflange FF	N5
Socket weld female (rating = Y0)	S1
Threaded female	T1
Flanged RF	F1
Flanged RTJ (not DIN)	F2
Flanged FF (not DIN)	F3
3-Valve integral manifold	M1
5-Valve integral manifold	M2
3-Valve direct manifold	M3
5-Valve direct manifold	M4
Kidney flange (1/2 in. tapping only)	K1
Chemical-tee	C1
Others	Z9

**Tapping size**

1/4 in.	T1
3/8 in.	T2
1/2 in.	T3
3/4 in.	T4
1 in.	T5
1 1/2 in.	T6
2 in.	T7
3 in.	T8
4 in.	T9
5 in. (chemical-tee only)	V1

Continued on next page...

XX	XX	XXX	XXX	XX	XXX	XX	XXX	XXX	XX	XXX
----	----	-----	-----	----	-----	----	-----	-----	----	-----

# FPD470 Wedge flowmeter

## Differential pressure – primary flow element

WEDGE flowmeter	FPD470	X	XX	XXX	XX	XX	XX	XX	XX	XX	XX	XX	XXX	XXX	XX	XXX	XX	XXX	XX	XXX	
		See pages 11			12	13	14	15	16	17											
<b>Tapping rating</b>																					
Others													Z9								
Socket weld													S1								
Butt weld													B1								
Chemical-tee													C1								
BSPT F													T1								
BSPT M													T2								
NPT F													T3								
NPT M													T4								
ASME Class 150													A1								
ASME Class 300													A3								
ASME Class 600													A6								
ASME Class 900													A7								
ASME Class 1500													A8								
ASME Class 2500													A9								
DIN PN 6													D0								
DIN PN 10													D1								
DIN PN 16													D2								
DIN PN 25													D3								
DIN PN 40													D4								
DIN PN 63													D5								
DIN PN 100													D6								
Flanges JIS 7.5K													J0								
Flanges JIS 10K													J1								
Flanges JIS 5K													J2								
Flanges JIS 20K													J3								
Flanges JIS 30K													J4								
API 2000 PSI TYPE 6BX													P1								
API 3000 PSI TYPE 6BX													P2								
API 5000 PSI TYPE 6BX													P3								
API 10000 PSI TYPE 6BX													P4								
API 15000 PSI TYPE 6BX													P5								
API 20000 PSI TYPE 6BX													P6								
Others													Z9								
<b>Number of tapping sets length and type</b>																					
One set													TN1								
Two sets													TN2								
Three sets													TN3								
Four sets													TN4								
Others													TNZ								
<b>Pipe orientation</b>																					
Horizontal													PNH								
Vertical													PNV								

Continued on next page...

**WEDGE flowmeter**

**FPD470**

X	XX	XXX	XX	XX	XX	XX	XX	XX	XX	XX	XX	XX	XX	XXX	XXX	XX	XXX	XX	XXX
See pages 11			12	13	14	15		16	17	See page 18									

**Welding code**

ASME B31.3 cyclic service	K1
ASME B31.3 category D service	K2
ASME B31.3 category M service	K3
ASME B31.4	K4
ASME B31.5	K5
PED B3.1 SEP level	K6
PED B3.1 category H	K7
Others	K9

**Surface treatment**

Primer to ABB standard (primer only)	HF1
Painted to ABB standard (primer and top coat)	HF2
Other (specify in detail)	HFZ

**Certification**

Material certificates acc. EN 10204 3.1	C2
Material certificates acc. EN 10204 3.2	C3
Material certificates acc. NACE, latest revision	CN
Dye penetrant inspection	C9
Radiography	C8
Positive material identification (NITRON XRF)	CA
100 % dimensional check	C6
Others	CZ

**Testing**

Impact testing @ -46 °C (-50.8 °F)	CH1
Impact testing @ -196 °C (-320.8 °F)	CH2
Hardness survey	CH3
HIC testing	CH4
Magnetic particle inspection	CH5
Ultrasonic inspection	CH6
Heat treatment trace	CH7
Pressure test (internal)	CH8
Others	CHZ

**Calibration**

Bi-directional flow calibration with water	RW2
Others	RWZ

**Documentation language (default = M5 / English)**

German	M1
Italian	M2
Spanish	M3
French	M4
English	M5
Chinese	M6

**Added requirements**

Material source limitations apply	MS1
-----------------------------------	-----

# Contact us

## **ABB Limited**

### **Process Automation**

Salterbeck Trading Estate  
Workington  
Cumbria CA14 5DS  
UK

Tel: +44 (0)1946 830 611

Fax: +44 (0)1946 832 661

## **ABB Inc.**

### **Process Automation**

125 E. County Line Road  
Warminster, PA 18974  
USA

Tel: +1 215 674 6000

Fax: +1 215 674 7183

[www.abb.com](http://www.abb.com)

## Note

We reserve the right to make technical changes or modify the contents of this document without prior notice. With regard to purchase orders, the agreed particulars shall prevail. ABB does not accept any responsibility whatsoever for potential errors or possible lack of information in this document.

We reserve all rights in this document and in the subject matter and illustrations contained therein. Any reproduction, disclosure to third parties or utilization of its contents in whole or in parts – is forbidden without prior written consent of ABB.

Copyright© 2016 ABB

All rights reserved



Sales



Service