

Service unit combinations MSE6, MSE series



Service unit combinations MSE6, MSE series

Key features

Overview

Product description			
<p>The MSE6-E2M is an intelligent pneumatic service unit for optimising the use of compressed air as an energy medium in industrial automation technology.</p> <p>Equipped with measurement, control and diagnostic functions, the</p>	<p>MSE6-E2M supports energy-efficient operation of pneumatic systems. The MSE6-E2M detects increased compressed air consumption in the standard production cycle which may be caused by leakages, for example, and enables targeted system</p>	<p>maintenance. Furthermore, the MSE6-E2M detects when the production plant is in a standby state and stops the supply of compressed air in order to prevent unnecessary compressed air consumption.</p>	<p>The MSE6-E2M can also be used as a process monitoring module by enabling flow and pressure values to be transferred directly to the machine controller via a fieldbus connection, where they can be analysed.</p>

Product features

Control function (energy efficiency function)	Recording and provision of measurement data	Limit monitoring	Fieldbus connection
<ul style="list-style-type: none"> - Automatic shut-off when flow rate is not achieved - User-controlled shut-off and pressurising 	<ul style="list-style-type: none"> - Output pressure - Pressure change (for pressure tightness testing) - Flow - Air consumption 	<ul style="list-style-type: none"> - Pressure, upper limit value - Pressure change, upper limit value - Flow, upper limit value 	<ul style="list-style-type: none"> - PROFIBUS DP - PROFINET IO - EtherNet/IP - EtherCAT

Installation

The module is typically assembled behind a service unit combination.

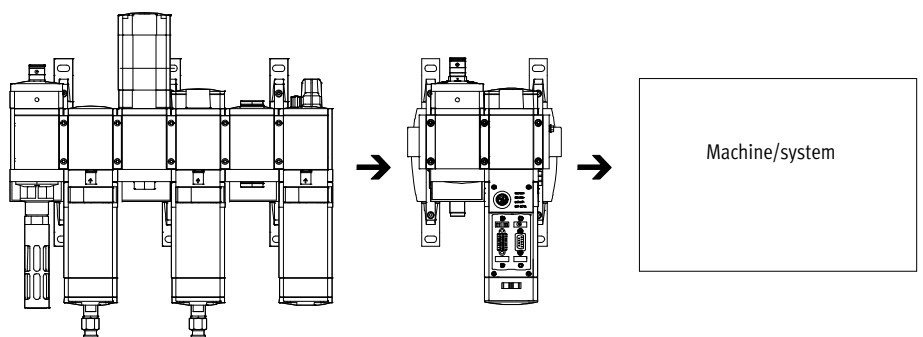

Structure

The main components of the MSE6-E2M are: shut-off valve, flow sensor, pressure sensor and bus node. The fieldbus interface allows complete integration into a higher-order controller, e. g. a system or machine controller. As an alternative to integration into a higher-order controller, the MSE6-E2M can also be operated using an external operator unit or a PC.

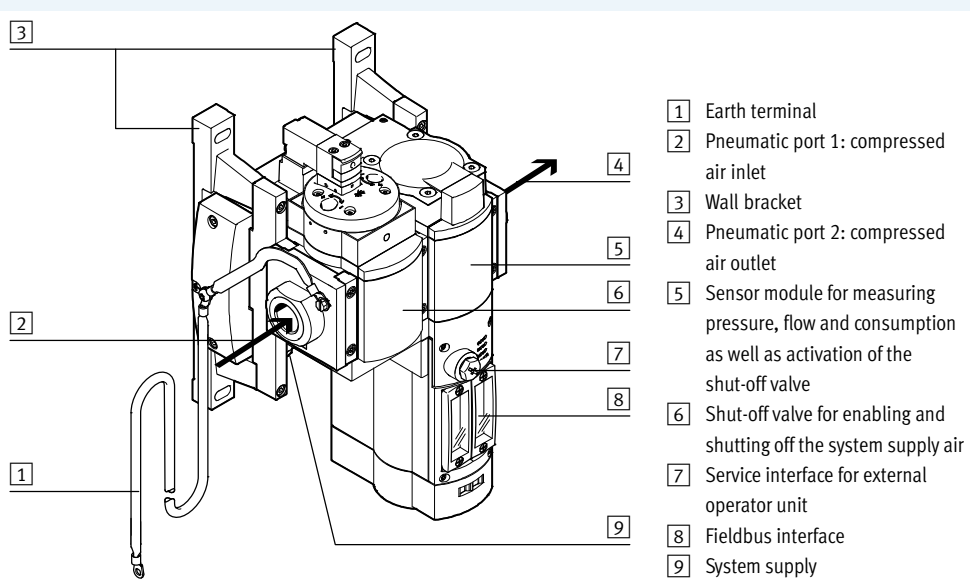

Service unit combinations MSE6, MSE series

Key features

Functions

Standby detection and automatic shut-off of the compressed air supply

The MSE6-E2M uses settable parameters to detect when the production system is down. The system is separated from the compressed air supply using a 2/2-way shut-off valve, without exhausting the downstream system. This avoids additional air consumption through leakages. If production is to continue on the

system, then this must be signalled to the MSE6-E2M. The shut-off valve opens and the system is again supplied with compressed air. Automatic shut-off of the compressed air supply can be activated and deactivated by the user. In the deactivated state, the shut-off valve can be controlled directly by the PLC.

Pressure tightness testing

When in the shut-off state, the MSE6-E2M measures the pressure curve over time. Even in well-maintained systems, the pressure falls continuously due to leakages. The fewer leakages the system has, the slower the pressure

drop will be. The measured pressure change serves as a measure of the leakage existing in the system. If the parameterised limit value is exceeded, then the device will output a diagnostic message.

Pressure recording

The MSE6-E2M continuously measures the output pressure, prepares the data and makes it available cyclically. To detect high operating pressures, the MSE6-E2M offers the option of parameterising limit values for pressure. If the parameterised limit value is exceeded, then the device will output a diagnostic message.

Flow recording

The MSE6-E2M continuously records the flow, prepares the data and makes it available cyclically. To detect high flow rates, the MSE6-E2M offers the option of parameterising limit values for the flow. If the parameterised limit value is exceeded, then the device will output a diagnostic message.

Consumption recording

The MSE6-E2M determines the compressed air consumption by recording the system flow rate. The user has the option of using appropriate signalling to record the compressed air consumption over a specific period of time.

Note

If there is an error (e.g. fieldbus interruption, PLC failure, no voltage) on the MSE6-E2M, the shut-off valve switches to the initial position (pressurise) if the system parameters are set accordingly. If the valve was previously closed, the system is

pressurized. If the system was vented, pressurisation takes place suddenly. Use suitable counter measures to prevent unintentional pressurisation of the system in the event of an error.

Service unit combinations MSE6, MSE series

Peripherals overview

Peripherals overview

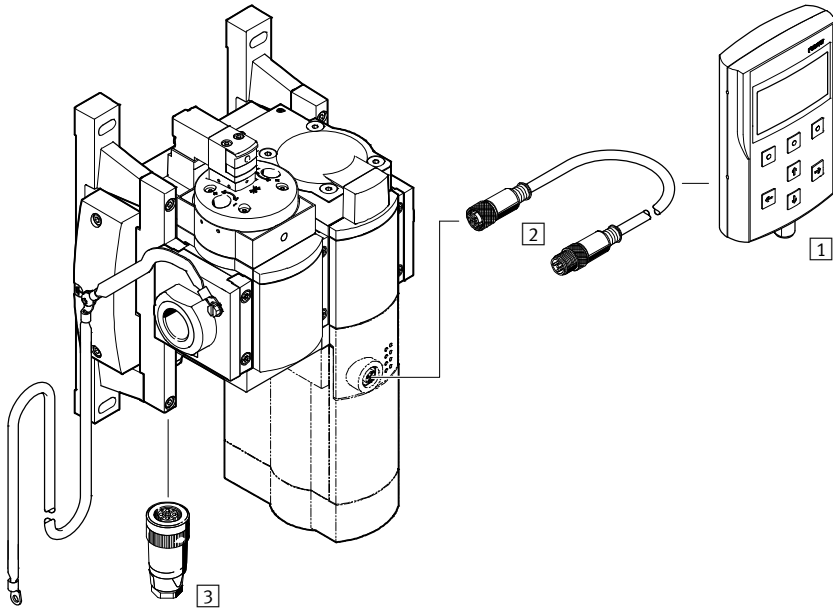

Fieldbus node FB13 for PROFIBUS DP

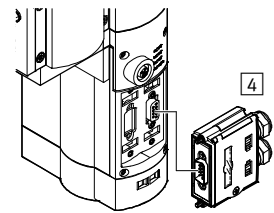

Fieldbus node FB33 for PROFINET IO with M12 port

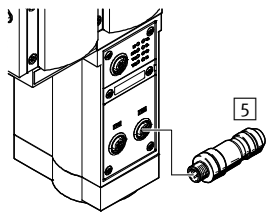

Fieldbus node FB34 for PROFINET IO with RJ45 port

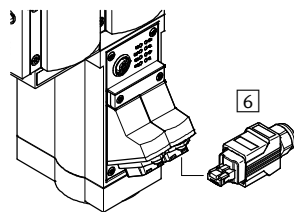

Fieldbus node FB35 for PROFINET IO with SCRJ port

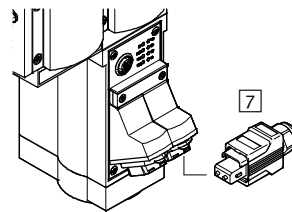

Fieldbus node FB36 for EtherNet/IP, fieldbus node FB37 for EtherCAT

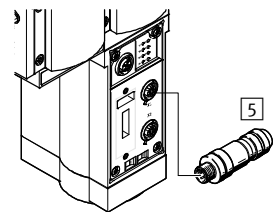

Accessories		→ Page/Internet
1	Operator unit CPX-MMI-1	16
2	Connecting cable KV-M12-M12	16
3	Plug socket NTSD	16
4	Plug connector FBS-SUB-9	16
5	Plug connector NECU-M-S-D12G4	16
6	Plug connector FBS-RJ45	16
7	Plug connector FBS-SCRJ	16
-	Wall mounting-SET for same wall gap of a service unit combination MS6 for mounting with MSE6 MS6-WPG	ms6-wpg

Service unit combinations MSE6, MSE series

Type code

Type codes

MSE 6 - E2M - 5000 - FB13 - AGD

Series

MSE	Modular standard, electric
-----	----------------------------

Size

6	Grid dimension 62 mm
---	----------------------

Function

E2M	Energy efficiency module
-----	--------------------------

Flow measuring range

5000	5000 l/min
------	------------

Electrical actuation

FB13	Fieldbus node for PROFIBUS DP
FB33	Fieldbus node for PROFINET IO with M12 port
FB34	Fieldbus node for PROFINET IO with RJ45 port
FB35	Fieldbus node for PROFINET IO with SCRJ port
FB36	Fieldbus node for EtherNet/IP
FB37	Fieldbus node for EtherCAT

Pneumatic connection

AGD	Connecting plate G1/2
-----	-----------------------

Service unit combinations MSE6, MSE series

Technical data – Fieldbus node FB13 for PROFIBUS DP

FESTO

MSE6-E2M-...-FB13

Consisting of

- Energy efficiency module
 - 2/2 shut-off valve, open, monostable
 - Flow sensor
 - Pressure sensor for outlet pressure
 - Control unit for processing measuring data, activating valves and controlling energy efficiency functions
- Fieldbus node for PROFIBUS DP

 - Operating pressure
4 ... 10 bar

 - Temperature range
0 ... +50°C

PROFI[®]
BUS



General technical data	
Pneumatic port 1, 2	G $\frac{1}{2}$ (sub-base)
Mounting position	Horizontal $\pm 5^\circ$
Flow direction	Unidirectional P1 \rightarrow P2
Valve function	2/2 shut-off valve, open, monostable
Reset method	Mechanical

Electrical data	
System supply	
Electrical connection	Plug connector M18x1, 4-pin
Operating voltage range for load voltage [V DC]	18 ... 26.4
Operating voltage range for electronics/sensors [V DC]	18 ... 30
Current consumption for actuator technology [mA]	Max. 100 when valve is fed with current
Current consumption for electronics/sensors at 24 V [mA]	Max. 300
Reverse polarity protection	For operating voltage connections
Degree of protection	IP65 with plug socket
Duty cycle [%]	100
Fieldbus connection	
Fieldbus interface	Sub-D socket, 9-pin

Standard nominal flow rate q_n ¹⁾	
Pneumatic connection	G $\frac{1}{2}$
In main direction of flow 1 \rightarrow 2 [l/min]	4500

1) Measured at p1 = 6 bar and p2 = 5 bar, $\Delta p = 1$ bar

Service unit combinations MSE6, MSE series

Technical data – Fieldbus node FB13 for PROFIBUS DP

Operating and environmental conditions	
Operating pressure [bar]	4 ... 10
Operating medium	Compressed air to ISO 8573-1:2010 [7:4:4]
Note on operating/pilot medium	Lubricated operation not possible
Ambient temperature [°C]	0 ... +50
Temperature of medium [°C]	0 ... +50
Storage temperature [°C]	-10 ... +60
Corrosion resistance class CRC ¹⁾	2
CE marking (see declaration of conformity)	To EU EMC Directive ²⁾
Certification	RCM Mark

- 1) Corrosion resistance class CRC 2 to Festo standard FN 940070
Moderate corrosion stress. Indoor applications in which condensation may occur. External visible parts with primarily decorative requirements for the surface and which are in direct contact with the ambient atmosphere typical for industrial applications.
- 2) For information about the applicability of the component see the manufacturer's EC declaration of conformity at: www.festo.com/sp → Certificates.
If the component is subject to restrictions on usage in residential, office or commercial environments or small businesses, further measures to reduce the emitted interference may be necessary.

Display/operation	
Flow measurement	
Flow measurement range start value [l/min]	50
Flow measuring range end value [l/min]	5000
Accuracy of flow rate	+/- (3% of measured value + 0.3% FS) ¹⁾
Displayable unit(s)	l/min (preset)
	scfm
Pressure measurement	
Pressure measuring range start value [bar]	0
Pressure measuring range end value [bar]	14
Accuracy in ±%FS ¹⁾ [%FS]	3
Displayable unit(s)	mbar (preset)
	kPa
	psi
Consumption measurement	
Displayable unit(s)	l (preset)
	m ³
	scf

1) % FS = % of measuring range final value (full scale)

Weight	
Product weight [g]	3300

Materials	
Housing	Die-cast aluminium
End cap	Reinforced PA
Cover	Reinforced PA
Seals	NBR

Service unit combinations MSE6, MSE series

Technical data – Fieldbus node FB13 for PROFIBUS DP

Pin allocation, system supply		
Plug connector M18x1, 4-pin	Pin	Meaning
	1	Operating voltage for electronics/sensors +24 V DC
	2	Operating voltage for actuator technology +24 V DC
	3	0 V
	4	Functional earth

Dimensions Download CAD data → www.festo.com

1 Plug connector M18x1, 4-pin
2 M12x1 socket, 5-pin
3 Sub-D socket, 9-pin
➔ Flow direction

Type	B1	B2	B3	B4	B5	B6	B7	B8	B9
MSE6-E2M-...-FB13	178	150	124	99	75	45	100	55	62

Type	B10	L1	L2	L3	L4	L5	L6	L7	L8
MSE6-E2M-...-FB13	7	285	98	217	197	86	7	21	292

Ordering data				
Size	Pneumatic connection	Electrical actuation	Part no.	Type
MSE6	G1/2	Fieldbus node FB13 for PROFIBUS DP	2465321	MSE6-E2M-5000-FB13-AGD



Service unit combinations MSE6, MSE series

Technical data – Fieldbus node FB33/FB34/FB35 for PROFINET IO

MSE6-E2M-...-FB33/FB34/FB35

Consisting of

- Energy efficiency module
 - 2/2 shut-off valve, open, monostable
 - Flow sensor
 - Pressure sensor for outlet pressure
 - Control unit for processing measuring data, activating valves and controlling energy efficiency functions
- Fieldbus node for PROFINET IO

-  - Operating pressure
4 ... 10 bar
-  - Temperature range
0 ... +50°C



General technical data	
Pneumatic connection 1, 2	G $\frac{1}{2}$ (sub-base)
Mounting position	Horizontal $\pm 5^\circ$
Flow direction	Unidirectional P1 \rightarrow P2
Valve function	2/2 shut-off valve, open, monostable
Reset method	Mechanical

Electrical data			
Type	MSE6-E2M-...-FB33	MSE6-E2M-...-FB34	MSE6-E2M-...-FB35
System supply			
Electrical connection	Plug connector M18x1, 4-pin		
Operating voltage range for load voltage [V DC]	18 ... 26.4		
Operating voltage range for electronics/sensors [V DC]	18 ... 30		
Current consumption for actuator technology [mA]	Max. 100 when valve is fed with current		
Current consumption for electronics/sensors at 24 V [mA]	Max. 320	Max. 320	Max. 400
Reverse polarity protection	For operating voltage connections		
Degree of protection	IP65 with plug socket		
Duty cycle [%]	100		
Fieldbus connection			
Fieldbus interface	2x M12x1 sockets, 4-pin, D-coded	2x RJ45 sockets, push-pull, AIDA	2x SCR1 sockets, push-pull, AIDA

Standard nominal flow rate $q_{nN}^{1)}$	
Pneumatic connection	G $\frac{1}{2}$
In main direction of flow 1 \rightarrow 2 [l/min]	4500

1) Measured at $p_1 = 6$ bar and $p_2 = 5$ bar, $\Delta p = 1$ bar

Service unit combinations MSE6, MSE series

Technical data – Fieldbus node FB33/FB34/FB35 for PROFINET IO

Operating and environmental conditions		
Operating pressure	[bar]	4 ... 10
Operating medium		Compressed air to ISO 8573-1:2010 [7:4:4]
Note on operating/pilot medium		Lubricated operation not possible
Ambient temperature	[°C]	0 ... +50
Temperature of medium	[°C]	0 ... +50
Storage temperature	[°C]	-10 ... +60
Corrosion resistance class CRC ¹⁾		2
CE marking (see declaration of conformity)		To EU EMC Directive ²⁾
Certification		RCM Mark

- 1) Corrosion resistance class CRC 2 to Festo standard FN 940070
Moderate corrosion stress. Indoor applications in which condensation may occur. External visible parts with primarily decorative requirements for the surface and which are in direct contact with the ambient atmosphere typical for industrial applications.
- 2) For information about the applicability of the component see the manufacturer's EC declaration of conformity at: www.festo.com/sp → Certificates.
If the component is subject to restrictions on usage in residential, office or commercial environments or small businesses, further measures to reduce the emitted interference may be necessary.

Display/operation		
Flow measurement		
Flow measurement range start value	[l/min]	50
Flow measuring range end value	[l/min]	5000
Accuracy of flow rate		+/- (3% of measured value + 0.3% FS) ¹⁾
Displayable unit(s)		l/min (preset)
		scfm
Pressure measurement		
Pressure measuring range starting value	[bar]	0
Pressure measuring range end value	[bar]	14
Accuracy in ±%FS ¹⁾	[%FS]	3
Displayable unit(s)		mbar (preset)
		kPa
		psi
Consumption measurement		
Displayable unit(s)		l (preset)
		m ³
		scf

1) % FS = % of measuring range final value (full scale)

Weight			
Type	MSE6-E2M-...-FB33	MSE6-E2M-...-FB34	MSE6-E2M-...-FB35
Product weight	[g]	3350	3450

Materials	
Housing	Die-cast aluminium
End cap	Reinforced PA
Cover	Reinforced PA
Seals	NBR

Service unit combinations MSE6, MSE series

Technical data – Fieldbus node FB33/FB34/FB35 for PROFINET IO

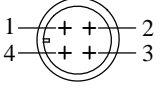
Pin allocation, system supply		
Plug connector M18x1, 4-pin	Pin	Meaning
	1	Operating voltage for electronics/sensors +24 V DC
	2	Operating voltage for actuator technology +24 V DC
	3	0 V
	4	Functional earth

Dimensions Download CAD data → www.festo.com

Fieldbus node FB33 for PROFINET IO with M12 port

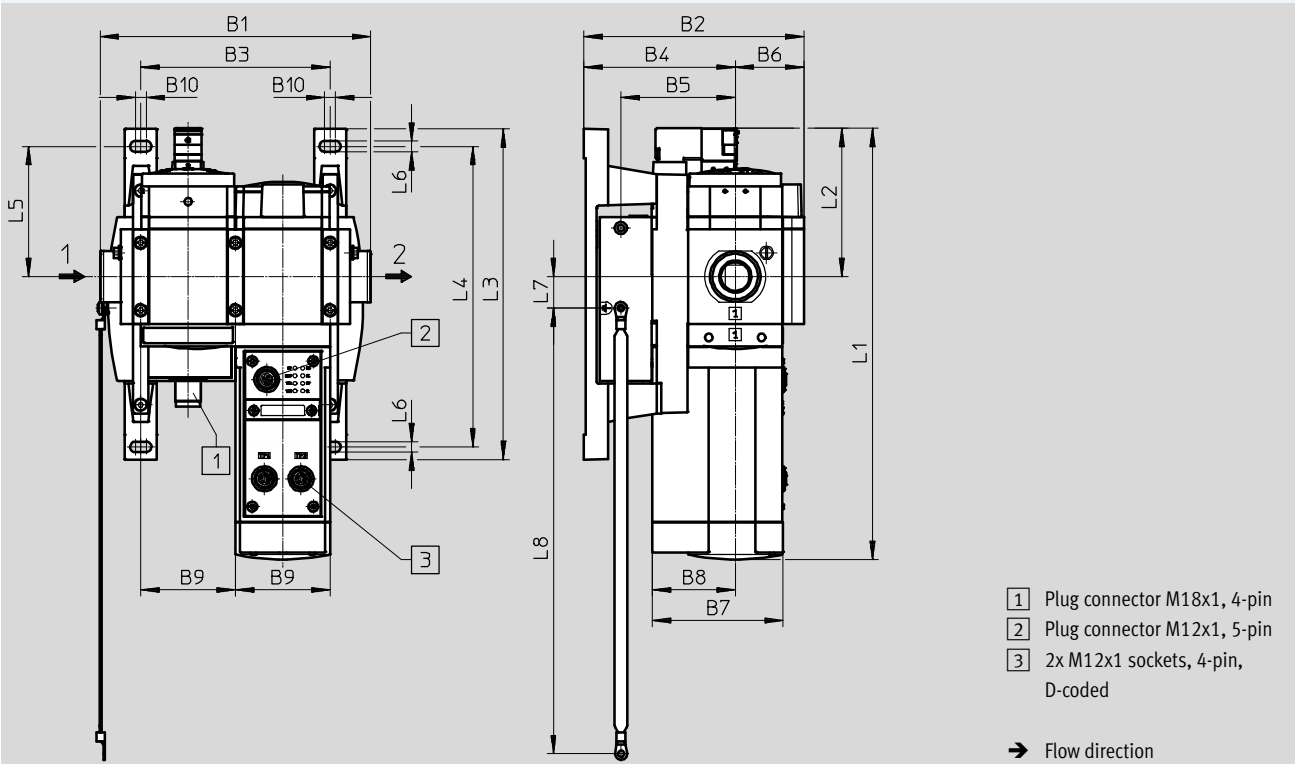

- 1 Plug connector M18x1, 4-pin
- 2 Plug connector M12x1, 5-pin
- 3 2x M12x1 sockets, 4-pin, D-coded

→ Flow direction

Type	B1	B2	B3	B4	B5	B6	B7	B8	B9
MSE6-E2M-...-FB33	178	145	124	99	75	45	86	55	62

Type	B10	L1	L2	L3	L4	L5	L6	L7	L8
MSE6-E2M-...-FB33	7	285	98	217	197	86	7	21	292

Service unit combinations MSE6, MSE series

Technical data – Fieldbus node FB33/FB34/FB35 for PROFINET IO

Dimensions

Download CAD data → www.festo.com

Fieldbus node FB34/FB35 for PROFINET IO with RJ45/SCRJ port

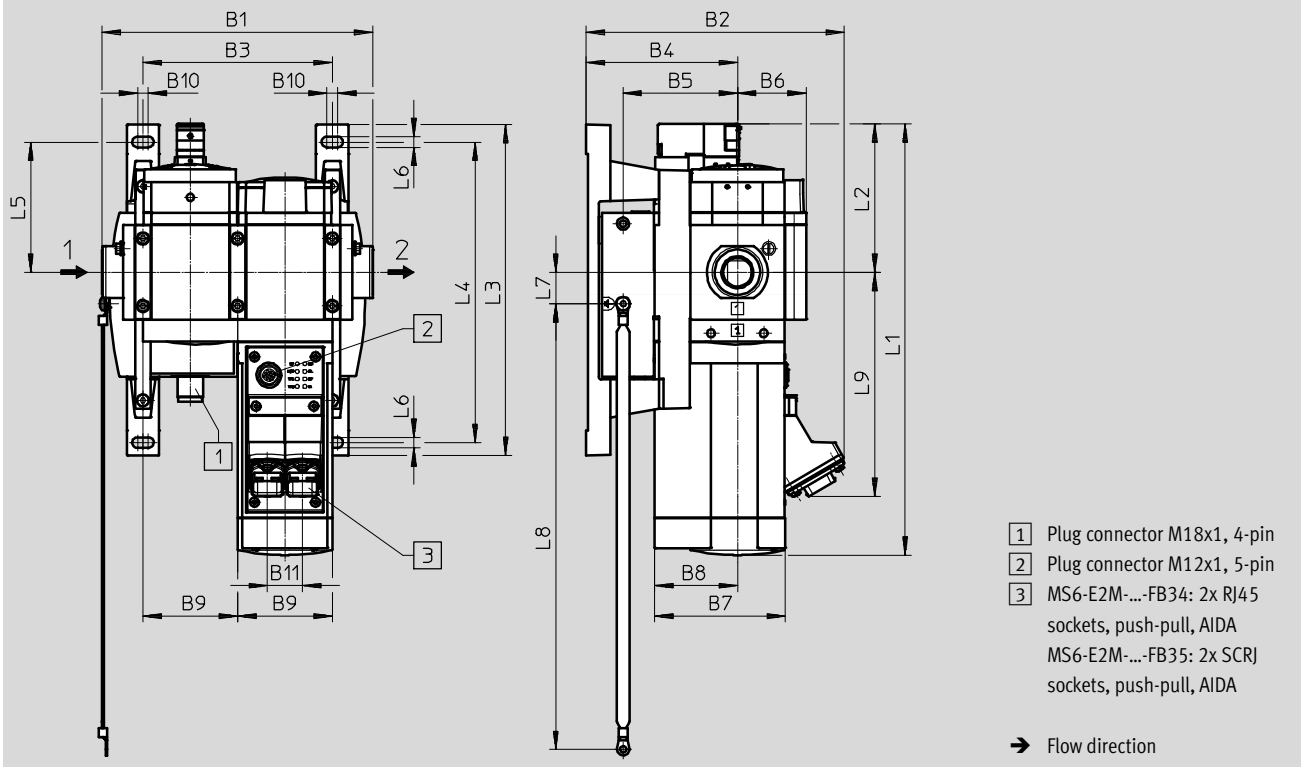

Type	B1	B2	B3	B4	B5	B6	B7	B8	B9	B10
MSE6-E2M-...-FB34/FB35	178	170	124	99	75	45	86	55	62	7

Type	B11	L1	L2	L3	L4	L5	L6	L7	L8	L9
MSE6-E2M-...-FB34/FB35	23	285	98	217	197	86	7	21	292	147

Ordering data

Size	Pneumatic connection	Electrical actuation	Part no.	Type
MSE6	G $\frac{1}{2}$	Fieldbus node FB33 for PROFINET IO with M12 port	3850287	MSE6-E2M-5000-FB33-AGD
		Fieldbus node FB34 for PROFINET IO with RJ45 port	3869585	MSE6-E2M-5000-FB34-AGD
		Fieldbus node FB35 for PROFINET IO with SCRJ port	3870296	MSE6-E2M-5000-FB35-AGD

Service unit combinations MSE6, MSE series

Technical data – Fieldbus node FB36 for EtherNet/IP and FB37 for EtherCAT

MSE6-E2M-...-FB36

Consisting of

- Energy efficiency module
 - 2/2 shut-off valve, open, monostable
 - Flow sensor
 - Pressure sensor for outlet pressure
 - Control unit for processing measuring data, activating valves and controlling energy efficiency functions
- Fieldbus node for EtherNet/IP or EtherCAT

 - Operating pressure
4 ... 10 bar

 - Temperature range
0 ... +50°C

 EtherNet/IP™

 EtherCAT®



General technical data	
Pneumatic port 1, 2	G $\frac{1}{2}$ (sub-base)
Mounting position	Horizontal $\pm 5^\circ$
Flow direction	Unidirectional P1 \rightarrow P2
Valve function	2/2 shut-off valve, open, monostable
Reset method	Mechanical

Electrical data	
System supply	
Electrical connection	Plug connector M18x1, 4-pin
Operating voltage range for load voltage [V DC]	18 ... 26.4
Operating voltage range for electronics/sensors [V DC]	18 ... 30
Current consumption for actuator technology [mA]	Max. 100 when valve is fed with current
Current consumption for electronics/sensors at 24 V [mA]	Max. 300
Reverse polarity protection	For operating voltage connections
Degree of protection	IP65 with plug socket
Duty cycle [%]	100
Fieldbus connection	
Fieldbus interface	2x M12x1 sockets, 4-pin, D-coded

Standard nominal flow rate $q_{nN}^{1)}$	
Pneumatic connection	G $\frac{1}{2}$
In main direction of flow 1 \rightarrow 2 [l/min]	4500

1) Measured at p1 = 6 bar and p2 = 5 bar, $\Delta p = 1$ bar

Service unit combinations MSE6, MSE series

Technical data – Fieldbus node FB36 for EtherNet/IP and FB37 for EtherCAT

Operating and environmental conditions		
Operating pressure	[bar]	4 ... 10
Operating medium		Compressed air to ISO 8573-1:2010 [7:4:4]
Note on operating/pilot medium		Lubricated operation not possible
Ambient temperature	[°C]	0 ... +50
Temperature of medium	[°C]	0 ... +50
Storage temperature	[°C]	-10 ... +60
Corrosion resistance class CRC ¹⁾		2
CE marking (see declaration of conformity)		To EU EMC Directive ²⁾
Certification		RCM Mark

- 1) Corrosion resistance class CRC 2 to Festo standard FN 940070
Moderate corrosion stress. Indoor applications in which condensation may occur. External visible parts with primarily decorative requirements for the surface and which are in direct contact with the ambient atmosphere typical for industrial applications.
- 2) For information about the applicability of the component see the manufacturer's EC declaration of conformity at: www.festo.com/sp → Certificates.
If the component is subject to restrictions on usage in residential, office or commercial environments or small businesses, further measures to reduce the emitted interference may be necessary.

Display/operation		
Flow measurement		
Flow measurement range start value	[l/min]	50
Flow measuring range end value	[l/min]	5000
Accuracy of flow rate		+/- (3% of measured value + 0.3% FS) ¹⁾
Displayable unit(s)		l/min (preset)
		scfm
Pressure measurement		
Pressure measuring range start value	[bar]	0
Pressure measuring range end value	[bar]	14
Accuracy in ±%FS ¹⁾	[%FS]	3
Displayable unit(s)		mbar (preset)
		kPa
		psi
Consumption measurement		
Displayable unit(s)		l (preset)
		m ³
		scf

1) % FS = % of measuring range final value (full scale)

Weight		
Product weight	[g]	3300

Materials	
Housing	Die-cast aluminium
End cap	Reinforced PA
Cover	Reinforced PA
Seals	NBR

Service unit combinations MSE6, MSE series

Technical data – Fieldbus node FB36 for EtherNet/IP and FB37 for EtherCAT

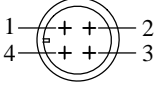
Pin allocation, system supply		
Plug connector M18x1, 4-pin	Pin	Meaning
	1	Operating voltage for electronics/sensors +24 V DC
	2	Operating voltage for actuator technology +24 V DC
	3	0 V
	4	Functional earth

Dimensions Download CAD data → www.festo.com

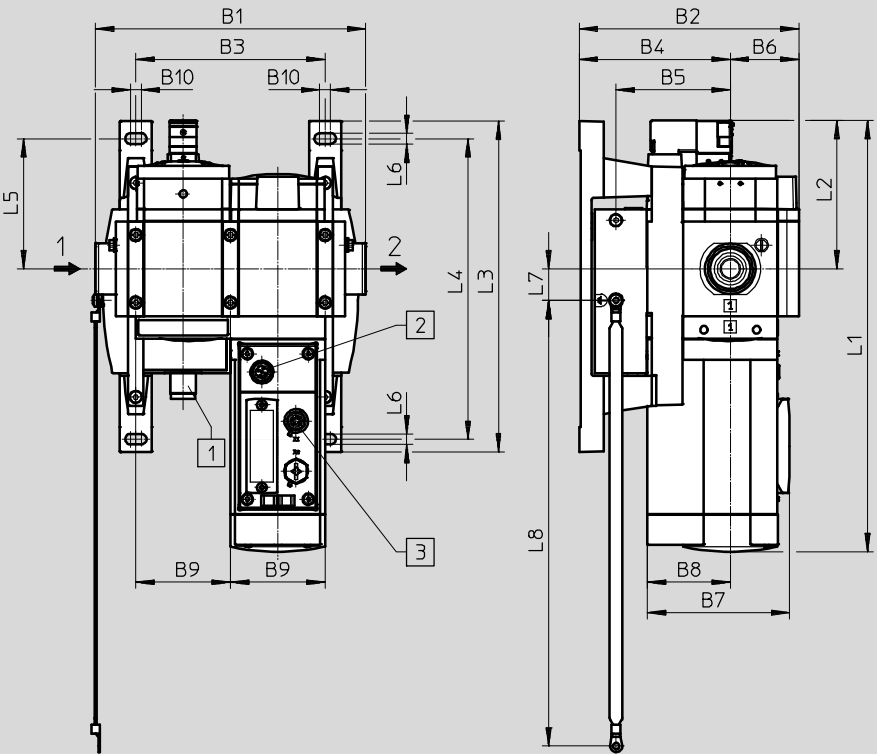

1 Plug connector M18x1, 4-pin
2 M12x1 socket, 5-pin
3 2x M12x1 sockets, 4-pin, D-coded

→ Flow direction

Type	B1	B2	B3	B4	B5	B6	B7	B8	B9
MSE6-E2M-...-FB36/FB37	178	145	124	99	75	45	94	55	62

Type	B10	L1	L2	L3	L4	L5	L6	L7	L8
MSE6-E2M-...-FB36/FB37	7	285	98	217	197	86	7	21	292

Ordering data			
Size	Pneumatic connection	Electrical actuation	Part no. Type
MSE6	G $\frac{1}{2}$	Fieldbus node FB36 for EtherNet/IP	3990296 MSE6-E2M-5000-FB36-AGD
		Fieldbus node FB37 for EtherCAT	3992150 MSE6-E2M-5000-FB37-AGD

Service unit combinations MSE6, MSE series

FESTO

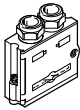

Accessories

Ordering data – Plug FBS-SUB-9			Technical data → Internet: fbs-sub-9	
Description	Electrical connection		Part no.	Type
 For fieldbus node FB13 for PROFIBUS DP	Plug connector, 9-pin, Sub-D		532216	FBS-SUB-9-GS-DP-B

Ordering data – Plug connector NECU-M-S-D12G4			Technical data → Internet: necu	
Description	Electrical connection		Part no.	Type
 For fieldbus node FB33 for PROFINET IO, for fieldbus node FB36 for EtherNet/IP, for fieldbus node FB37 for EtherCAT	Plug connector M12x1, 4-pin, D-coded	Screw terminal, can be screened	543109	NECU-M-S-D12G4-C2-ET

Ordering data – Plug connector FBS-RJ45			Technical data → Internet: fbs	
Description	Electrical connection		Part no.	Type
 For fieldbus node FB34 for PROFINET IO	Plug connector RJ45, 8-pin, push-pull		552000	FBS-RJ45-PP-GS

Ordering data – Plug connector FBS-SCRJ			Technical data → Internet: fbs	
Description	Electrical connection		Part no.	Type
 For fieldbus node FB35 for PROFINET IO	Plug connector SCRJ, 2-pin, push-pull		571017	FBS-SCRJ-PP-GS

Ordering data – Plug socket NTSD			Technical data → Internet: ntscd	
Description	Cable connector	Connecting cross-section [mm ²]	Part no.	Type
			 Straight socket, 4-pin, screw terminal	Pg9
	Pg13	2.5	18526	NTSD-GD-13,5
 Angled socket, 4-pin, screw terminal	Pg9	1.5	18527	NTSD-WD-9

Ordering data – Operator unit CPX-MMI-1			Technical data → Internet: cpx-mmi-1	
Description			Part no.	Type
 Provides data polling, configuration and diagnostic functions			529043	CPX-MMI-1

Ordering data – Connecting cable KV-M12-M12			Technical data → Internet: kv-m12-m12	
Description	Cable length [m]	Part no.	Type	
		 Connecting cable for operator unit CPX-MMI-1	1.5	529044
	3.5	530901	KV-M12-M12-3,5	